



KD Campus Pvt. Ltd

2007, OUTRAM LINES, 1ST FLOOR, OPPOSITE MUKHERJEE NAGAR POLICE STATION, DELHI-110009

Answer-key & Solution

SSC JE (Mechanical)
MOCK -(123)
Date 18/11/2017

1. B	26. A	51. B	76. C	101 D	126 A	151 C	176 B
2. A	27. D	52. D	77. B	102 B	127 C	152 C	177 C
3. C	28. A	53. D	78. A	103 C	128 B	153 D	178 D
4. B	29. C	54. C	79. B	104 C	129 B	154 D	179 B
5. B	30. D	55. A	80. A	105 A	130 D	155 A	180 D
6. D	31. C	56. D	81. C	106 D	131 D	156 C	181 D
7. B	32. C	57. B	82. C	107 C	132 C	157 B	182 D
8. D	33. A	58. C	83. C	108 D	133 C	158 D	183 B
9. C	34. B	59. A	84. B	109 B	134 C	159 B	184 A
10. D	35. C	60. D	85. C	110 B	135 B	160 C	185 C
11. C	36. A	61. B	86. A	111 D	136 A	161 A	186 C
12. C	37. C	62. B	87. B	112 B	137 C	162 D	187 C
13. A	38. D	63. C	88. A	113 C	138 C	163 D	188 D
14. C	39. B	64. A	89. C	114 C	139 B	164 A	189 A
15. D	40. C	65. D	90. A	115 A	140 B	165 A	190 D
16. C	41. B	66. A	91. A	116 C	141 C	166 B	191 C
17. D	42. D	67. B	92. C	117 D	142 D	167 A	192 D
18. B	43. D	68. C	93. A	118 C	143 C	168 B	193 C
19. C	44. B	69. B	94. A	119 B	144 C	169 C	194 D
20. D	45. C	70. A	95. A	120 B	145 B	170 D	195 A
21. B	46. C	71. B	96. B	121 D	146 B	171 B	196 D
22. D	47. B	72. C	97. B	122 B	147 C	172 D	197 D
23. C	48. D	73. C	98. B	123 B	148 B	173 C	198 D
24. B	49. B	74. B	99. D	124 A	149 C	174 A	199 B
25. B	50. B	75. C	100. B	125 C	150 C	175 C	200 C

Note : If your opinion differ regarding any answer, please message the mock test and Question number to 9560620353

Note : If you face any problem regarding result or marks scored, please contact : 9313111777

SOLUTION SSC JE (Mechanical) MOCK TEST no. 123

1. (B) Botany is the branch of science which deals with the study of plants. Similarly, Entomology is the branch of science which deals with the study of insects.

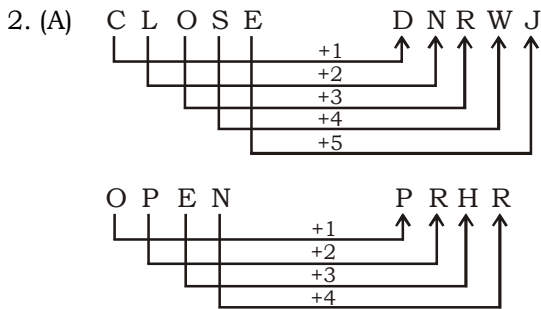

3. (C) $\sqrt[3]{729} = 9 \Rightarrow 9^2 = \mathbf{81}$
 $\sqrt[3]{125} = 5 \Rightarrow 5^2 = 25$

4. (B) The relationship is $x : \left(\frac{x}{2} + 1\right)$ or
 $20 : \left(\frac{20}{2} + 1\right)$ or $20 : 11$ in the same way,
 $102 : \left(\frac{102}{2} + 1\right)$ or $102 : (51 + 1)$ or,
 $102 : 52$

5. (B) In all other pairs,

$$\frac{\text{1st number} - 1}{7} = \text{2nd number}$$

6. (D) Except diagonal, all are the part of circle whereas diagonal is the part of a parallelogram.

7. (B) In all other numbers, the sum of the digits is 17.

8. (D) All other groups contain alternate letters of the alphabet.

9. (C) If day before yesterday was Saturday, then today is Monday. Thus, tomorrow will be Tuesday and day after tomorrow will be Wednesday.

10. (D) We have $A = 2, B = 3, \dots, Z = 27$.

Then, FOR
 $= F + O + R = 7 + 16 + 19 = 42$.

FRONT = F + R + O + N + T
 $= 7 + 19 + 16 + 15 + 21 = 78$

11. (C) The only daughter of woman's father is she herself. So, the person is woman's son, i.e., the woman is the person's mother.

12. (C) There is no letter 'Y' in the given word. So, AGENCY cannot be formed.

13. (A) In this series, 5 is added to the previous number and the number 70 is inserted at every third number.

14. (C) 1st letter

$$N \xrightarrow{-3} K \xrightarrow{-3} \mathbf{H} \xrightarrow{-3} E \xrightarrow{-3} B$$

2nd letter

$$5 \xrightarrow{+2} 7 \xrightarrow{+3} \mathbf{10} \xrightarrow{+4} 14 \xrightarrow{+5} 19$$

3rd letter

$$V \xrightarrow{-2} T \xrightarrow{-2} \mathbf{R} \xrightarrow{-2} P \xrightarrow{-2} N$$

15. (D) The series is aab / aaab / aaaab / aaaaab. Thus, the number of a's is increasing by one in the successive sequence.

16. (C) Sumit is 17th from the last and Ravi is 7 ranks ahead of Sumit. So, Ravi is 24th from the last.

Number of students ahead of Ravi in rank
 $= (39 - 24) = 15$.

So, Ravi is 16th from the start.

17. (D) Using option (D),

$$36 - 6 + 3 \times 5 \div 3 = 74$$

$$\Rightarrow 36 \times 6 \div 3 + 5 - 3 = 74$$

$$\Rightarrow 36 \times 2 + 5 - 3 = 74$$

$$\Rightarrow 72 + 5 - 3 = 74$$

$$\therefore 74 = 74$$

18. (B) $(1.732)^2 = (\sqrt{3})^2 = 3, 3^2 = 9, 9^2 = 81,$

$$81^2 = 6561, (6561)^2 = 43046721$$

19. (C) $5 \times 6 \times 7 = 210 \Rightarrow \frac{210}{10} = 21$

$$6 \times 5 \times 4 = 120 \Rightarrow \frac{120}{10} = 12$$

$$3 \times 4 \times 5 = 60 \Rightarrow \frac{60}{10} = 6$$

$$8 \times 7 \times 5 = 280 \Rightarrow \frac{280}{10} = \mathbf{28}$$

20. (D)

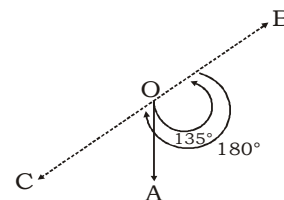

As shown in the above figure the man initially faces in the direction OA. On moving 135° anti-clockwise, he faces in the direction OB. On further moving 180° clockwise, he faces in the direction OC, which is South-West.

21. (B) Both wall and window are parts of a room.
But wall and window are entirely different.

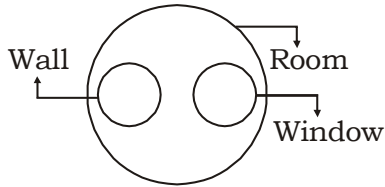

22. (D) $48 = (1 + 5) \times (7 + 1)$
 $55 = (9 + 2) \times (2 + 3)$
and $80 = (3 + 7) \times (4 + 4)$
 $\therefore 54 \times 32 = (5 + 4) (3 + 2)$
 $= 9 \times 5 = 45$

23. (C)

24. (B) Clearly, we have to find a number which lies inside the triangle, rectangle and circle, which is 4.

25. (B) P \rightarrow 56, **69**, 75, 87, 98

O \rightarrow 59, 65, 77, **88**, 96

L \rightarrow 55, 67, 78, **86**, 99

E \rightarrow 04, 10, **23**, 32, 41

26. (A) The relationship is $x : x^2(x - 1)$ or
 $11 : 11^2(11 - 1)$ or, $11 : 121(10)$ or, $11 : 1210$.
In the same way $8 : 8^2(8 - 1)$ or $8 : 64(7)$ or,
 $8 : 448$.

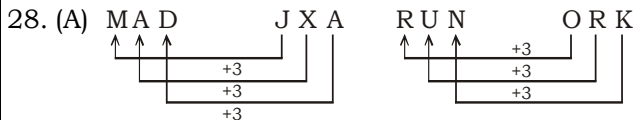
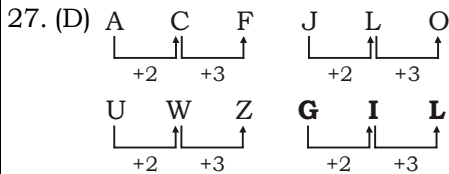

29. (C) As, Love and Hate are Antonyms to each other. Similarly, friend and **enemy** are antonyms to each other.

30. (D) Except option (D), The digits can be obtained by replacing their places.

31. (C) Except simmer, all are connected with light, while simmer is a way of cooking.

32. (C) Except **Dam**, all are natural whereas Dam is artificial.

33. (A) Except 48, each no. is 1 more than the square of a certain number.

34. (B) Clearly, the last bell rang 45 min before 7 : 45 am i.e., 7 : 00 am. But it happened five minutes before the priest gave the information to the devotee. So, the information was given at 7 : 05 am.

35. (C) Seventh letter from the left is A and the third letter to its right is K.

36. (A) $5^3 + 4^2 = 141$
 $6^3 + 2^2 = 220$

$7^3 + 3^2 = 352$

37. (C) **Word** **Number of consonants** **Number of vowels**

LIRIL	3	2	$\Rightarrow 3^2 + 2^2 = 13$
LUX	2	1	$\Rightarrow 2^2 + 1^2 = 5$
RIN	2	1	$\Rightarrow 2^2 + 1^2 = 5$
PEARS	3	2	$\Rightarrow 3^2 + 2^2 = 13$
DOVE	2	2	$\Rightarrow 2^2 + 2^2 = 8$

38. (D) Crude, Cruise, Crumb, Crupper, Crusade.

39. (B) Using option (B) for exchanging the signs,
 $(16 - 4) \times 6 \div 2 + 8 = 30$

$\Rightarrow (16 \div 4) \times 6 - 2 + 8 = 30$

$\Rightarrow 4 \times 6 - 2 + 8 = 30$

$\Rightarrow 24 - 2 + 8 = 30$

$\therefore 30 = 30$

40. (C) The movements of Radha's are as shown in figure. Clearly, Radha's distance from the starting point.

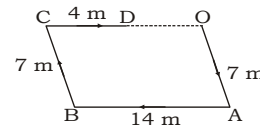

$OD = (OC - CD) = (AB - CD)$
 $= (14 - 4)m = 10m$

41. (B) We have

$(16 - 6)^2 + (5 - 2)^2 = 10^2 + 3^2 = 109$

$(22 - 15)^2 + (21 - 19)^2 = 7^2 + 2^2 = 53$

So, missing number

$= (17 - 13)^2 + (51 - 48)^2 = 4^2 + 3^2 = 25$

42. (D) The correct pattern is

$\times 2 + 1, \times 3 + 1, \times 2 + 1, \dots$

So, 356 is wrong and must be replaced by $(129 \times 3 + 1)$ i.e., 388.

43. (D)

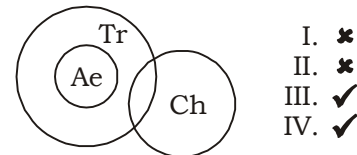

44. (B) $4 \times 9 = 36; 3 + 6 = 9 \Rightarrow 369$

$6 \times 4 = 24; 2 + 4 = 6 \Rightarrow 246$

$7 \times 3 = 21; 2 + 1 = 3 \Rightarrow 213$

45. (C) Clearly, X is the farthest West.

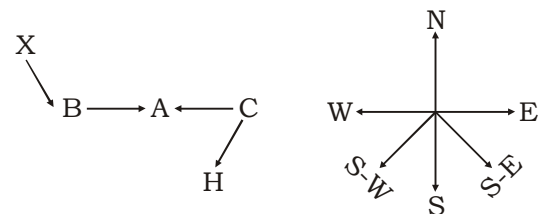

46. (C)

3	6	4
↓	↓	↓
3	1	5

 [Moving clockwise direction]

3	6	4
↓	↓	↓
3	1	5

2

Clearly, we can say that 4 is opposite to 5.

47. (B) $R \xrightarrow{+3} U \xrightarrow{+3} X \xrightarrow{+3} A \xrightarrow{+3} D \xrightarrow{+3} \textcircled{G}$

48. (D) The pattern is
 $\times 2 + 1, \times 2 + 2, \times 2 + 3, \dots$
 So, missing number is
 $59 \times 2 + 4 = \mathbf{122}$

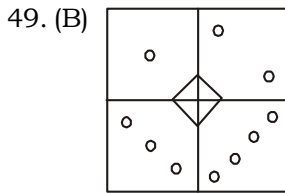

50. (B)

51. (B) Ajatasatru was a king of the Magadha empire in north India. He was the son of King Bimbisara, the great monarch of Magadha. He was contemporary to Mahavira and Buddha. According to the Jain tradition Bimbisara committed suicide while according to Buddhist tradition he was brutally murdered by his own son.

52. (D) In Germany, financial legislation is treated as ordinary legislation and is thus introduced in the upper house. Aside from this there are only three countries where financial legislation may be introduced in the upper house India, where the budget is introduced in both houses simultaneously and in Italy and Switzerland, the chambers have equal powers over all legislation.

54. (C) An isthmus is a narrow strip of land connecting two larger land areas, usually with water on either side. The Panama Canal crosses the Isthmus of Panama, connecting the North Atlantic and Pacific Oceans. The Suez Canal connects the Mediterranean Sea and the Indian Ocean, cutting across the western side of an isthmus formed by the Sinai Peninsula. Strait is the sea counterpart of isthmus.

57. (B) Income Tax (corporate and non-corporate combined) contribute about 56 percent of tax revenue of India. But, income tax, apart from agricultural income is shared between the Union and states. Among the given options, Excise duty is the chief and single largest source of revenue income. The Government of India earns maximum from Union Excise Duty.

58. (C) There is only one article pertaining to the Minorities in the Constitution of India.

Article 30 of the Constitution provides that all minorities, whether based on religion or language, shall have the right to establish and administer educational institutions of their choice. The Constitution thus envisages that minorities can be based on religion or language. Minorities are identified on the basis of percentage of the population of the Group to the total population.

59. (A) There are three primary colours-Red, Green and Blue (RGB). As these are mixed they form lighter colours and when all three are mixed together they appear as white. Cyan, Magenta and Yellow are the Primary colours used for printing the image.

60. (D) Simlipal National Park is a national park and an elephant reserve situated in the Mayurbhanj district in the Indian state of Orissa. Simlipal National Park derives its name from the abundance of Semul or red silk cotton trees that bloom vividly. Dehong Deband biosphere reserve is present in Arunachal Pradesh. Norkek biosphere reserve is present in Meghalay and Kanchenjunga biosphere reserve is situated in Sikkim.

61. (B) India's large service industry accounts for 57.2% of the country's GDP while the industrial and agricultural sectors contribute 28.6% and 14.6% respectively. Agriculture is the predominant occupation in Rural India, accounting for about 52% of employment. The service sector makes up a further 34% and in industrial sector it is around 14%.

62. (B) A bear is a speculator who is wary of fall in prices and hence sells securities so that he may buy them at cheap price in future. He does not have securities at present but sells them at higher prices in anticipation that he will supply them business purchasing at lower prices in the future. If the prices move down as per the expectations of the bear he will earn profits out of these transactions.

66. (A) The planimeter is a drafting instrument used to measure the area of a graphically represented planner region. The region being measured may have any irregular shape, making this instrument remarkably versatile. In this age of CAD and digital images, the planimeter is heading toward obsolescence, but not just yet. They are still being manufactured.

67. (B) Christiaan Neethling Barnard was a

- South African cardiac surgeon who performed the world's first successful human-to-human heart transplant. He performed the world's first human heart transplant operation on 3rd December 1967, in an operation assisted by his brother, Marius Barnard, the operation lasted nine hours and used a team of thirty people. The patient, Louis Washkansky was a 57 year old grocer, suffering from diabetes and incurable heart disease.
70. (A) Lee Falk was an American writer, theater director and producer, best known as the creator of the popular comic strips, the phantom and Mandrake the Magician. At the height of their popularity, these strips attracted over 100 million readers everyday. Falk also wrote short stories and he contributed to a series of pulp novels about the phantom.
73. (C) It was on 4th December, 1829, when the practice was formally banned in all the lands under Bengal Presidency by Lord William Bentinck. By this regulation, the people who abetted sati were declared guilty of "culpable homicide".
74. (B) Snakes have the maximum number of ribs. On an average they have 200 to 400 bones (Vertebrae) and each have a pair of ribs on either side.
75. (C) The Supreme Court has been given the power to decide whether a law passed by the Parliament or the State legislatures and the executive decisions taken by the Central or State government is constitutional or not. If such a law or executive decision is found unconstitutional, then it can declare it as invalid.
78. (A) The Indus Valley Civilization was noted for its cities built of brick, roadside drainage system and multistoried houses. The buildings were made of burnt bricks, which have been preserved even to this day. Sun-dried bricks were used for the foundation of the buildings and the roofs were flat and made of wood.
80. (A) Rhizobia are soil bacteria that fix nitrogen (diazotrophs) after becoming established inside root nodules of legumes. Rhizobia require a plant host, they cannot independently fix nitrogen. In general, they are Gram-negative, motile, non-sporulating rods.
81. (C) A Peshwa is the titular equivalent of a modern Prime Minister. Emperor Shivaji created the Peshwa designation in order to delegate administrative duties more effectively during the growth of the Maratha Empire.
82. (C) The Harshacharita is the biography of Indian Emperor Harsha by Banabhatta, also known as Bana, who was a Sanskrit writer of 7th century in India. He was the 'Asthana Kavi', meaning 'Court Poet' of king Harsha.
86. (A) Nuclear Fusion Reaction is the process which is responsible for the sun to radiate energy in the form of light and heat commonly known as solar energy. Fusion occurs when hydrogen atoms fuse together under extreme heat and pressure to create a denser helium atom releasing in the process, colossal amounts of energy.
88. (A) The fundamental condition of perfect competition is that there must be a large number of sellers or firms. Homogeneous Commodity is the second fundamental condition of a perfect market. The products of all firms in the industry are homogeneous and identical.
89. (C) Until it lost its planetary status in 2006, Pluto was the coldest with an estimated surface temperature between -235 and -210 degrees Celsius. But Pluto has now been relegated the status of a Dwarf Planet. Pluto has always had the 'honour' of being the coldest planet with an average temperature between -360 to -400 degrees Fahrenheit. This is because it is far away from the sun. It is over 40 times further from the sun than planet Earth. Pluto also has no internal heat source and it even orbits in a ring of ice debris.
90. (A) Like many other things, milk contains bacteria, Milk also naturally contains a kind of sugar known as "lactose". The bacteria that live in milk get energy from this special sugar and use it to reproduce to make even more bacteria. When the bacteria use the lactose sugars to reproduce, they change it from "lactose sugar" into "lactic acid", which tastes sour.
91. (A) Smiling Buddha (Pokhran-I) is an assigned code-name of India's first nuclear weapon explosion, which took place on 18 May 1974. The device was detonated by the Indian Army in the army base, Pokhran Test Range, Rajasthan.

96.(B) The pressure exerted by a static fluid depends only upon the depth of the fluid, the density of the fluid and the acceleration of gravity. The pressure in a static fluid arises from the weight of the fluid and is given by the expression $P_{\text{fluid}}^{\text{static}} = dgh$, where d = fluid density, g = acceleration due to gravity and h = depth of fluid. Static fluid pressure does not depend on the shape, total mass or surface area of the liquid.

98.(B) Zero Hour in Parliament starts at 12 noon during which members raise matters of importance, especially those that cannot be delayed. Zero Hour is the Indian innovation in the field of parliamentary procedures and has been in existence since 1962. However, it does not find mention in the rules of procedure. During zero hour, questions are asked about issues of public importance without prior permission. These questions are usually directed against individual ministers.

118.(C) $d = 7 \text{ cm}$

$L = 8 \text{ cm}$

$r_c = 8$

$$r_c = \left(\frac{V_s + V_c}{V_c} \right)$$

$$V_c = \text{Swept volume} = \frac{\pi}{4} D^2 \times L = 307.87 \text{ cm}^3$$

$V_c = \text{Clarence volume}$

$$8 = \frac{307.87 + V_c}{V_c} = 43.98 \text{ cm}^3$$

$$V_c = 43.98 \text{ cm}^3$$

$$V_c \simeq 44 \text{ cm}^3$$

126.(A) Degree of reaction

$$= \frac{\text{Enthalpy drop in moving blade}}{\text{Enthalpy drop in stage}}$$

Degree of reaction for impulse turbine = 0

Degree of reaction for reaction turbine = 1

132.(C) In impulse turbine the pressure both side of blade. Because Total pressure drop occur in nozzle.

142.(D) A key whose thicknes h , length l and width b .

In key matrial shear stress σ_s and crushing stress σ_c is.

shear force = crushing force

$$\sigma_s \times l \times b = \sigma_c \times l \times h / 2$$

$$\sigma_s \times l \times b = 2 \times \sigma_s \times l \times h / 2$$

$$b = h$$

$$143.(C) \text{ Coil index} = \frac{\text{Average diameter of coil}}{\text{diameter of wire}}$$

$$144.(C) \text{ Tearing efficiency of rivet} = 35\%$$

Diameter of riveted hole = (d)

Pitch interval of rivet = (p)

Tearing efficiency of rivet

$$= \frac{\text{Tearing strength of plate}}{\text{Strength of solid plate}}$$

$$\frac{35}{100} = \frac{(p-d) \times t \times f_t}{P \times t \times f_t}$$

$$\frac{d}{p} = 0.65$$

$$146.(B) \text{ Gear ratio} = \frac{D_G}{D_P} = 3$$

$$\Rightarrow D_G = 3D_P$$

$$\frac{D_G}{2} + \frac{D_P}{2} = 200$$

$$\frac{3D_P}{2} + \frac{D_P}{2} = 200$$

$$D_P = 100 \text{ mm}$$

$$\text{Module } (m) = \frac{D_P}{T_P} = \frac{100}{20} = 5 \text{ mm}$$

$$149.(C) \omega = \sqrt{\frac{g}{h}}$$

$$= \sqrt{\frac{10}{.1}}$$

$$\omega = 10 \text{ rad/sec}$$

$$152.(C) e_{\text{max}} = (\epsilon_1 - \epsilon_2) = (1000 + 600) \times 10^{-6} = 1600 \times 10^{-6}$$

$$153.(D) T_e = \sqrt{M^2 + T^2} = \sqrt{9 + 16} = 5 \text{ kN.m}$$

$$198.(D) \sigma = 0.073 \text{ N/m}$$

$$d = 1 \text{ mm}$$

$$p = \frac{4\sigma}{d}$$

$$= \frac{4 \times 0.073}{0.001} = 292 \text{ N/m}^2$$