



KD Campus Pvt. Ltd

2007, OUTRAM LINES, 1ST FLOOR, OPPOSITE MUKHERJEE NAGAR POLICE STATION, DELHI-110009

Answer-key & Solution

SSC JE (Civil)
MOCK -(124)
Date 25/11/2017

1. B	26. B	51. B	76. C	101. D	126. D	151. C	176. C
2. B	27. A	52. B	77. D	102. D	127. A	152. C	177. C
3. C	28. D	53. C	78. A	103. B	128. A	153. A	178. A
4. D	29. A	54. A	79. B	104. C	129. A	154. A	179. B
5. B	30. D	55. B	80. C	105. C	130. B	155. B	180. D
6. C	31. A	56. D	81. D	106. C	131. A	156. B	181. A
7. C	32. D	57. D	82. D	107. B	132. A	157. A	182. A
8. B	33. D	58. D	83. D	108. A	133. D	158. A	183. A
9. C	34. D	59. A	84. B	109. B	134. D	159. D	184. C
10. B	35. B	60. D	85. B	110. C	135. B	160. C	185. C
11. B	36. B	61. A	86. A	111. B	136. A	161. B	186. B
12. C	37. D	62. D	87. A	112. A	137. D	162. C	187. B
13. B	38. C	63. A	88. C	113. C	138. B	163. C	188. C
14. C	39. C	64. D	89. B	114. A	139. D	164. B	189. C
15. B	40. B	65. C	90. B	115. C	140. B	165. B	190. B
16. B	41. D	66. A	91. C	116. D	141. D	166. D	191. A
17. B	42. C	67. A	92. B	117. C	142. C	167. C	192. A
18. B	43. D	68. D	93. C	118. D	143. A	168. C	193. A
19. D	44. D	69. B	94. C	119. B	144. B	169. C	194. D
20. A	45. B	70. D	95. B	120. C	145. C	170. C	195. A
21. B	46. C	71. B	96. C	121. C	146. D	171. B	196. C
22. C	47. A	72. B	97. B	122. A	147. B	172. B	197. B
23. C	48. C	73. A	98. C	123. A	148. A	173. B	198. C
24. A	49. D	74. B	99. C	124. B	149. C	174. D	199. A
25. C	50. C	75. A	100. C	125. B	150. C	175. C	200. C

Note : If your opinion differ regarding any answer, please message the mock test and Question number to 9560620353

Note : If you face any problem regarding result or marks scored, please contact : 9313111777

SOLUTION SSC JE (Civil) MOCK TEST no. 124

1. (B) A Monarch is a type of Butterfly and Cobra is a type of Snake.
2. (B) Previous prime number to 97 is 89. Similarly for 43, the previous prime number is 41.
3. (C) Letter B E A C
Position 2 5 1 3
 ↓ ↓
 $(2 \times 5) \times (2 + 5) = 70$ $(1 \times 3) \times (1 + 3) = 12$
4. (D) A Huckster is one who deals in Advertising and a Gangster is one who deals in Crime.
5. (B) The country of Argentina neighbours the country of Brazil. Similarly, Iraq shares the borders with Iran.
6. (C) In all except Trifle, 'tri' indicates 'three'.
7. (C) Orange is the only citrus fruit in the group.
8. (B) All except Director spend money.
9. (C) Except (C), in rest of the options, second can be obtained by Multiplying 2.5 to first.
10. (B) The statement requests people not to use lift while moving down. This implies that the lift may be used to move up and the request has been made so that more people can use the lift for ascending which would otherwise cause more physical stress than going down the stairs. So, we can conclude that only II is implicit.

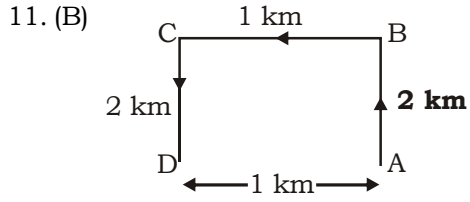

So, initially the boy rode 2 km Northward.

12. (C) $(4 + 8) \times 9 = 108 \Rightarrow 108 \times 10 = 1080$
 $(5 + 4) \times 12 = 108 \Rightarrow 108 \times 10 = 1080$
13. (B) $2 * 3 \Rightarrow 2^3 + 3^2 = 8 + 9 = 17 \Rightarrow 17^2 = 289$
 $3 * 4 \Rightarrow 3^3 + 4^2 = 27 + 16 = 43 \Rightarrow 43^2 = 1849$
 $2 * 4 \Rightarrow 2^3 + 4^2 = 8 + 16 = 24 \Rightarrow 24^2 = 576$
14. (C) Father and mother are parents but they are two different entity.
15. (B) The pattern is $\div 1, \div 2, \div 3, \div 4, \div 5$.
So, missing term = $360 \div 1 = 360$.
16. (B) The pattern is $\times 3, + 4, \times 5, + 6, \times 7, \dots$.
So, missing term = $1022 + 8 = 1030$.
17. (B) MOUSE
18. (B) When Rahul was born, his brother's age = 6 years
His father's age = $(6 + 32)$ years = 38 years
His mother's age = $(38 - 3)$ years = 35 years

- His sister's age = $(35 - 25)$ years = 10 years.
19. (D)
 20. (A) When the sheet shown in question figure is folded to form a box (cuboid), then the two rectangular-shaded faces lie opposite to each other, two rectangular white faces lie opposite to each other and the two square shaped faces (one shaded and one white) lie opposite to each other. Clearly, the cuboids shown in figures (2) and (4) cannot be formed as in each of the two cuboids the two shaded rectangular faces appear adjacent to each other. So, only the cuboids in figures (1) and (3) can be formed.
 21. (B)
 22. (C)
 23. (C)
 24. (A) All the number in the given set are prime numbers. Here, 5 is also a prime number and it belongs to the same group.
 25. (C)
 26. (B) First is moved with the help of second.
 27. (A) As, $61 = (4)^3 - 3$, $121 = (5)^3 - 4$, $337 = (7)^3 - 6$
Therefore, $? = (6)^3 - 5 = 211$

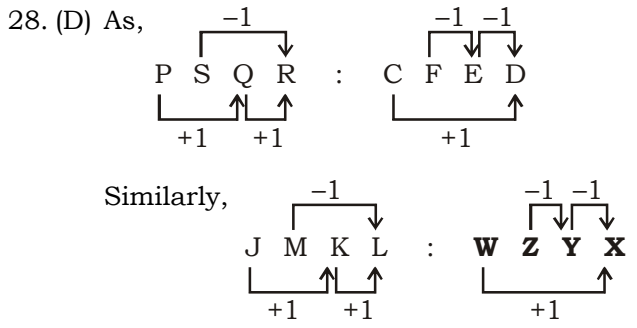

29. (A) As, $Q \xrightarrow{-4} M$ Similarly, $Y \xrightarrow{-4} U$
 $I \xrightarrow{+4} M$ $A \xrightarrow{+4} E$
 $O \xrightarrow{-4} K$ $W \xrightarrow{-4} S$
 $K \xrightarrow{+4} O$ $C \xrightarrow{+4} G$

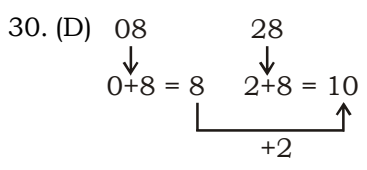

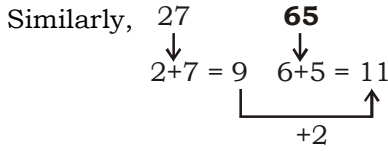

31. (A) All except **Barber** requires raw material to work.
 32. (D) All except **Cabbage** grow underground.
 33. (D) All other can be used to answer "where".

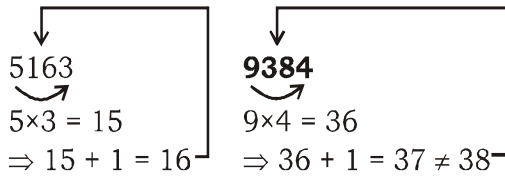
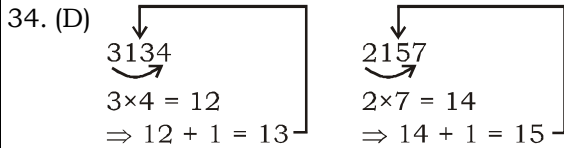

35. (B) Reverse of K = P, Reverse of G ≠ R, Reverse of U = F and Reverse of M = N.
 36. (B) After changing the signs we have,
 $91 \div 7 - 4 \times 2 + 3 = 13 - 4 \times 2 + 3$
 $= 13 - 8 + 3 = 16 - 8 = 8$

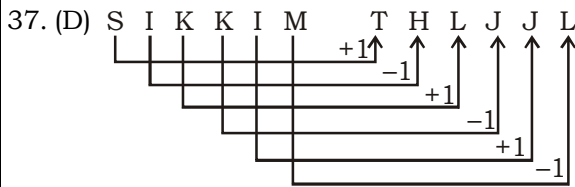

Similarly,

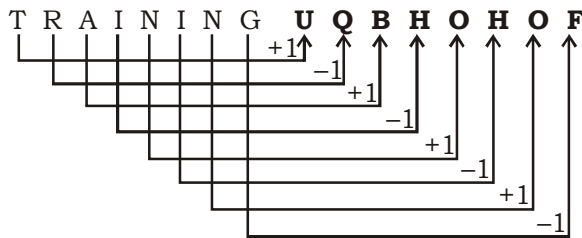

38. (C) Clearly, from 1 to 100, there are ten numbers with 3 as the unit's digit (3, 13, 23, 33, 43, 53, 63, 73, 83, 93).
 Ten numbers with 3 as the ten's digit (30, 31, 32, 33, 34, 35, 36, 37, 38, 39).
 So, required number = 10 + 10 = 20.
 39. (C) The figure may be marked as shown.

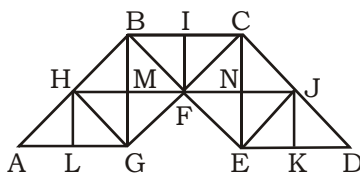

The simplest triangles are AHL, LHG,

GHM, HMB, GMF, BMF, BIF, CIF, FNC, CNJ, FNE, NEJ, EKJ and JKD i.e. 14 in number.

Triangles composed of two components are AGH, BHG, HBF, BFG, HFG, BCF, CJF, CJE, JEF, CFE and JED i.e. 11 in number.
 Triangles composed of four components are ABG, CBG, BCE and CED i.e. 4 in number.

Total number of triangles in the given figure = 14 + 11 + 4 = 29.

40. (B) Captain is also one of the member of a group.
 So, we can say that in 16 persons one captain is also included.

\therefore The number of captains = $\frac{1200}{16} = 75$

41. (D) Below mentioned are the two series which we can observe here :-

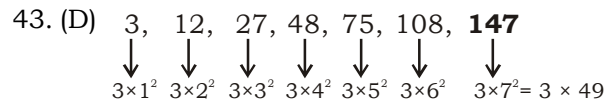
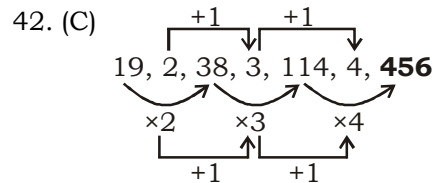
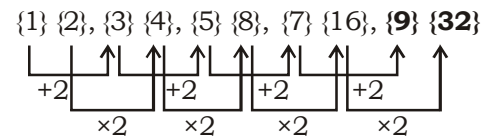

44. (D) Use the formula $\frac{M_1 D_1 H_1}{W_1} = \frac{M_2 D_2 H_2}{W_2}$.

Where M = Number of cats.
 D = Number of days.
 W = Number of mice. (Here 'eating mice' is a work)

Now, Let 4 cats would kill 4 mice in x days.

$\frac{100 \times 100}{100} = \frac{4 \times x}{4} \Rightarrow x = 100$ days.

So, 4 cats would kill 4 mice in 100 days.

45. (B) $(15 + 12)/9 = 3$
 and $(44 + 28)/9 = 8$
 Therefore, $(64 + 53)/9 = 13$.
 46. (C) $(30 - 24) \times 8 = 48$
 and $(23 - 12) \times 8 = 88$
 Therefore, $(92 - 86) \times 8 = 48$
 47. (A) Wheat and Paddy are different from each other but Wheat is a Rabi-Crop.
 48. (C) 49. (D) 50. (C)

55. (B) Kolar, Hutti, Gadag, Ramagiri, Honalli, Wyand, Lawa, Mysara, Pahardia, Kundredocha have been some of the gold mines of India. Presently gold is produced from three mines viz Hutti, Uti, Hirabuddni (HGML) in Karnataka and as by product from base-metal sulphide deposit of Khetri (Rajasthan), Mosabani, Singhbun (Jharkhand).
56. (A) The busiest rail section in respect to goods transportation is Delhi-Kolkata section.
62. (D) Molars are the posterior most and most complicated kind of tooth in most of the mammals. Adult humans have twelve molars. They are in four groups in which three are at the back of the mouth. The third, rearmost molar in each group is called a wisdom tooth.
63. (A) The processing of agricultural products, the production of grain by threshing, the production of flour by milling, the curing of skin and the production of leather, the production and preservation of meat and fish products, the preservation of fruit by drying, bottling, etc., the production of dairy products such as butter or cheese, the production of beer, wine or spirits, the production of baskets and mats, etc, come under processing of primary commodities for own consumption.
65. (C) Ethylene glycol (IUPAC name: ethane- 1,2-diol) is an organic compound widely used as an automotive antifreeze and a precursor to polymers. In its pure form, it is an odourless, colourless, syrupy, sweet-tasting liquid. Ethylene glycol is a toxic and ingestion which can result in death. Due to its low freezing point ethylene glycol resists freezing. A mixture of 60% ethylene glycol and 40% water freezes at - 45 degree C (-49 degree F). Diethylene glycol behaves similarly. It is used as a deicing fluid for windshields and aircraft. The antifreeze capabilities of ethylene glycol have made it an important component of vitrification (anticrystallization) mixture for low-temperature preservation of biological tissues and organs.
66. (A) In order to give more strength and more elasticity, natural rubber is heated with sulphur or sulphur compounds at 150°C temperature. Vulcanized rubber has good tensile strength. The working temperature of vulcanized rubber is enhanced up to 100°C. It has good resistance to organic solvents.
73. (A) Among the Standing Committees, the three Financial Committees i.e. Committees on Estimates, Public Accounts and Public Undertakings, constitute a distinct group as they keep an unremitting vigil over Government expenditure and performance. While Committees of the Rajya Sabha are associated with Committees on Public Accounts and Public Undertakings, the members of the Committee on Estimates are drawn entirely from the Lok Sabha.
74. (B) High levels of uric acid in the blood can cause solid crystals to form within joints. This causes a painful condition called Gout. If Gout remains untreated, these uric acid crystals can build up in the joints and nearby tissues forming hard lumpy deposits called tophi.
75. (A) In economics, the study of factor pricing is related to the theory of functional distribution which attempts to explain the prices of land, labour, and capital. It takes care of the demand for land, labour and capital as derived demand, stemming from the demand for final goods.
76. (C) In Haryana, the Bharatiya Janata Party and the Indian National Lok Dal won all the ten seats, with each party winning 5 each.
77. (D) Jim Corbett National Park is the oldest national park in India. The park has been named after the hunter and conservationist Jim Corbett who played a key role in its establishment. It was established in 1936 as Hailey National Park which is situated in Nainital district of Uttarakhand. The park acts as a protected area for the endangered Bengal tiger of India, the secure survival of which is the main objective of Project Tiger, an Indian wildlife protection initiative.
78. (A) The Ajanta Caves are in Aurangabad district of Maharashtra. The caves include paintings and sculptures considered to be masterpieces of Buddhist religious art (which depict the Jatak tales). The Ajanta cave paintings depict the life of Gautam Buddha.
79. (B) The money bill originates only in the Lok Sabha. No money bill can be introduced in the Lok Sabha without the prior approval of the president.



KD Campus Pvt. Ltd

2007, OUTRAM LINES, 1ST FLOOR, OPPOSITE MUKHERJEE NAGAR POLICE STATION, DELHI-110009

81. (D) Disposable income is total personal income minus personal current taxes. In national accounts definitions, personal income minus direct taxes equals disposable personal income.
84. (B) Ibn Batuta (also known as Shams-ud-din) was a Berber Muslim Moroccan explorer. He was known for his extensive travelling.
88. (C) The Reserve Bank has introduced banknotes in the Mahatma Gandhi Series since 1996 and has so far issued notes in the denominations of Rs. 5, Rs. 10, Rs. 20, Rs. 50, Rs. 100, Rs. 500 and Rs. 1000 in this series. Mahatma Gandhi series of Rs. 50 notes has the picture of Parliament of India on its reverse.
90. (B) The 'NOSHAD' attribute in HTML specifies that a horizontal line should render in one solid color (on shaded), instead of a shaded color. So, it displays the line in red.
91. (C) The first Law Commission was established in 1834 under the Charter Act of 1833 under the Chairmanship of Lord Macaulay which recommended codification of the Penal Code, the Criminal Procedure Code and a few other matters. Thereafter, the second, third and fourth Law Commissions were constituted in 1853, 1861 and 1879 respectively.
92. (B) The Minimum Wages Act, 1948 was enacted to safeguard the interests of workers, mostly in the unorganised sector for the fixation of minimum wages in certain specified employments. It binds the employers to pay their workers the minimum wages fixed under the Act from time to time. Under the Act, both the Central Government and the State Governments are the appropriate Governments to fix, revise, review and enforce the payment of minimum wages to workers in respect of 'scheduled employments' under their respective jurisdictions.
93. (C) A continent sized hole has been formed over Antarctica as a result of damage to the ozone layer. Most of the ozone is formed in the stratosphere over the equator and spreads by winds around the globe. Icy particles in polar stratospheric clouds catalyse the release of chlorine (from CFC) which destroys ozone. The formation of Ozone hole is maximum because in winter there is exceptionally cold.

94. (C) The most prevalent bulk material for solar cells is crystalline silicon (abbreviated in a group as c-Si.). It is also known as "solar grade silicon".
95. (B) All true crabs have 10 legs that are arranged in pairs. The front most is modified into pincers and other four pairs are used for locomotion. For some swimming crabs, the hindmost pair of legs is flattened to form paddles.
99. (C) Polytetrafluoroethylene (PTFE) is a synthetic fluoropolymer of tetrafluoroethylene that finds numerous applications. The best known brand name of PTFE is Teflon. PTFE is used as a non-stick coating for pans and other cookware as it is hydrophobic and possesses fairly high heat resistance.
100. (C) It is because the night side of Earth will radiate infra-red radiation (heat) back into the space. When there is cloud cover, the clouds act like a blanket and trap the heat just like a blanket traps heat close to our body.

101. (D) Buckling load, $P = \frac{\pi^2 EI}{(L_{eff})^2}$

In the given problem, $P_p = \frac{\pi^2 EI}{L^2}$ and

$$P_o = \frac{\pi^2 EI}{(2L)^2}$$

$$\therefore \frac{P_p}{P_o} = 4$$

102. (D) $P_{cr} = \frac{\pi^2 EI}{L^2} \Rightarrow 200 = \frac{\pi^2 EI}{(L/2)^2} \quad [L = L/2]$

$$\text{Buckling load} = 4 \frac{\pi^2 EI}{L^2} = 4 \times 200 = 800 \text{ kN}$$

103. (B) $x_{u, \max} = \frac{0.0035}{0.0055 + \frac{0.87 f_y}{E_s}}$

For $f_y = 415 \text{ N/mm}^2$ and $E_s = 2 \times 10^5 \text{ N/mm}^2$

$$x_{u, \max} = 0.48d$$

104. (C) $M_p = Z_p \times f_y$

$$\therefore f_y = \frac{120 \times 10^3}{5 \times 10^{-4}}$$

$$= 24 \times 10^7 \text{ N/m}^2$$

$$= 240 \text{ N/mm}^2$$

105. (C) Net sectional area of the plate = $(B - d')t$
 $= [300 - (16 + 1.5)] \times 10$
 $= 2825 \text{ mm}^2$

106. (C) Cohesion of clay, $c = \frac{q_u}{2} = \frac{54}{2} = 27 \text{ kPa}$

107. (B) The given data are $e = 0.7$ and $G = 2.67$
 The hydraulic gradient will be

$$i_c = \frac{G - 1}{1 + e} = \frac{2.67 - 1}{1 + 0.7} = 0.98$$

108. (A) $\tau = c + \sigma \tan \phi$
 $100 = 0 + 200 \tan \phi$
 $\phi = 26.56$

109. (B) Hydraulic depth,

$$R = \frac{A}{P} = \frac{2 \times 1}{2 \times 2} = 0.5 \text{ m}$$

$$Q = C\sqrt{RS} = 60 \times \sqrt{0.5 \times \frac{1}{800}} = 1.5 \text{ m}^3/\text{s}$$