

**SSC MOCK TEST – 8 (SOLUTION)**

1. (C) Fox and vixen are opposite genders. Similarly Hen and rooster are opposite genders.
2. (C) The room is a section of building. Similarly wheel is a section of cycle.
3. (C) 'When' is related to 'time'. Similarly 'where' is related to place.
4. (A) The number of 2s in the first part is **(4)** whereas in the second part we have **(5)** 2s.
5. (C)  $4831 \rightarrow 8 + 3 + 1 - 4 = 8$   
 $5437 \rightarrow 4 + 3 + 7 - 5 = 9$
6. (A)

11	12	17	13	3	6	13	11	
K	L	Q	M	→	C	F	M	K
↑	↑	↑	↑		↑	↑	↑	↑
					-8			
					-6			
					-4			
					-2			

14	18	16	20	6	12	12	18	
N	R	P	T	→	F	L	L	R
↑	↑	↑	↑		↑	↑	↑	↑
					-8			
					-6			
					-4			
					-2			
7. (B)

A	D	H	M
↓	↓	↓	↓
1	4	8	13
(Positions Alphabetically)			
Z	W	S	N
↓	↓	↓	↓
1	4	8	13
(Positions in reverse order)			
C	I	F	D
↓	↓	↓	↓
3	9	6	4
(Positions Alphabetically)			
<b>X</b>	<b>R</b>	<b>U</b>	<b>W</b>
↓	↓	↓	↓
3	9	6	4
(Positions in reverse order)			
8. (A)

O ← <b>P</b> → Q	J ← <b>K</b> → L
Z ← <b>A</b> → B	C ← <b>D</b> → E
Q ← <b>R</b> → S	B ← <b>C</b> → D
Z ← <b>A</b> → B	Z ← <b>A</b> → B
L ← <b>M</b> → N	L ← <b>M</b> → N
N ← <b>O</b> → P	O ← <b>P</b> → Q
T ← <b>U</b> → V	T ← <b>U</b> → V
M ← <b>N</b> → O	R ← <b>S</b> → T
S ← <b>T</b> → U	
9. (B) Ink is used in pen. Similarly ribbon is used in typewriter.
10. (A) Butter is made with the help of milk. Similarly book is made with the help of paper.
11. (A) Germany is a European country where as rest are Asian countries.
12. (D) Except Dion Nash, all are wicket keepers.
13. (C)  $\frac{8+7+6}{3+4} = \frac{21}{7} = 3$ ,  $\frac{3+6+6}{3+2+0} = \frac{15}{5} = 3$

14. (D)  $\frac{9+7+5}{2+1} = \frac{21}{3} = 7$ ,  $\frac{7+0+5}{3+0+1} = \frac{12}{4} = 3$
14. (D)  $\frac{12^2}{3} = \frac{144}{3} = 48$ ,  $\frac{18^2}{3} = \frac{324}{3} = 108$
- $\frac{24^2}{3} = \frac{576}{3} = 192$ ,
- $\frac{30^2}{3} = \frac{900}{3} = 300 \neq 360$
15. (D) Except Bhojpuri, all languages are mentioned in eighth schedule of the constitution.
16. (C) Radio is heard whereas others are seen.
17. (C)  $152 \rightarrow 3^3 + 5^3 = 27 + 125$   
(Square of continuous odd numbers)  
 $10 \rightarrow 1^3 + 3^3 = 1 + 9$   
(Square of continuous odd numbers)  
 $72 \rightarrow 2^3 + 4^3 = 8 + 64$   
(Square of continuous even numbers)  
 $468 \rightarrow 5^3 + 7^3 = 125 + 343$   
(Square of continuous odd numbers)
18. (A) Village → Block → Subdivision → District → Commisionary → State.
19. (D) Restaurant → Restore → Revolution  
(1) (2) (3)  
→ Revolve  
(4)
20. (B) ab/ a **b** c/a b **c** d/a **b** c **d** e/a b c d e **f**/a
21. (C) a b **c** d d/**c** b a/a b c d **d**/c b a
22. (B) 1 3 7 15 **31** 63 127  

↑	↑	↑	↑	↑	↑	↑
+2 <sup>1</sup>	+2 <sup>2</sup>	+2 <sup>3</sup>	+2 <sup>4</sup>	+2 <sup>5</sup>	+2 <sup>6</sup>	
(2)	(4)	(8)	(16)	(32)	(64)	
23. (B) 4 7 12 21 **38** 71  

↑	↑	↑	↑	↑	↑
×2 - 1	×2 - 2	×2 - 3	×2 - 4	×2 - 5	
24. (A) 12 23 67 265 **1321**  

↑	↑	↑	↑	↑
×2 - 1	×3 - 2	×4 - 3	×5 - 4	

= 265 × 5 - 4 = 1325 - 4 = 1321
25. (B)
26. (A)
27. (B)

<b>Month</b>	Jan	Feb	Mar	Apr	May	June
	↓	↓	↓	↓	↓	↓
<b>Code</b>	0	3	3	6	1	4
<b>Month</b>	July	Aug	Sept	Oct	Nov	Dec
	↓	↓	↓	↓	↓	↓
<b>Code</b>	6	2	5	0	3	5

$\frac{87+21+4+10}{7} = \frac{122}{7}$

$= 17 \times 7 + \boxed{3} \rightarrow$  remainder  
↓

3<sup>rd</sup> day is wednesday  
87 → Tens digit of year  
21 → Quotient of  $(87 \div 4)$   
4 → Code of months  
10 → Given date

28. (C) ∴ minute hand runs 55 minutes faster than hour hand in 60 minutes

∴ " " 1 "  $\frac{60}{55}$  "  
∴ " " 45 "  $\frac{60}{55} \times 45 = 49\frac{1}{11}$

So, at 3 :  $49\frac{1}{11}$  minutes both the hands will be in opposite directions.

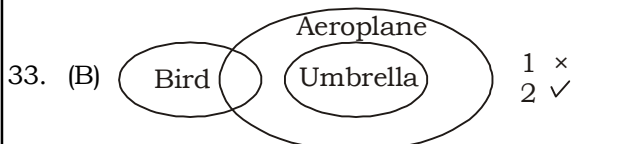
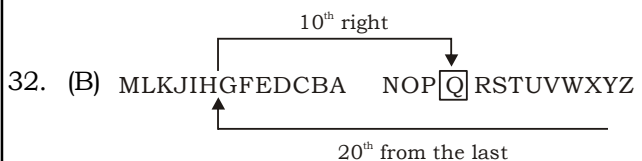
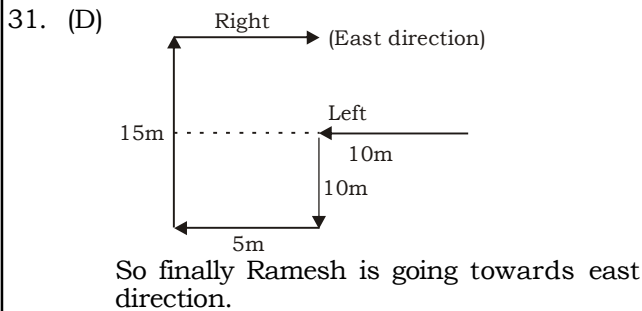
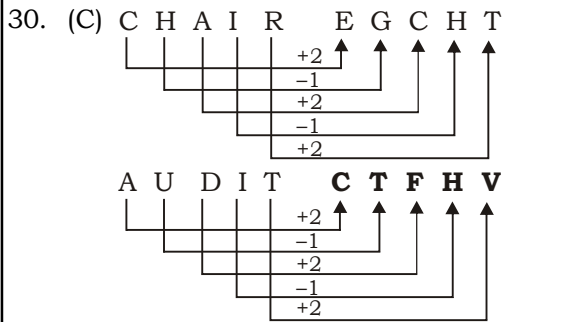
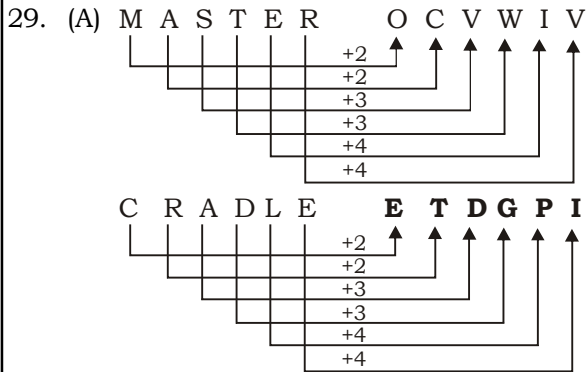

34. (B) The number of <math>\triangleleft</math> figure is each block is increasing by one i.e. 0, 1, 2 and 3.

35. (D) APPREHEND

36. (B) Length of the seventh (7<sup>th</sup>) line  
 $= 3 \times 2 \times 2 \times 2 \times 2 \times 2 \times 2 = 192$  cm

37. (A)

38. (D)                      39. (B)                      40. (B)

41. (B) As per the question,  $- = \times$ ,  $+ = +$ ,  $\times = -$   
Then,

$$100 - 10 \times 1000 + 1000 \times 100 \times 10$$

$$= 100 \times 10 - 1000 + 1000 - 100 \times 10$$

(After changing sign as per question)

$$= 1000 - 1000 + 1000 - 1000$$

$$= 2000 - 2000$$

$$= 0$$

42. (B)  $(16 - 6) \times (2 + 6) = 10 \times 8 = 80$

$$(9 - 4) \times (7 + 6) = 5 \times 13 = 65$$

$$(13 - 11) \times (16 + 8) = 2 \times 24 = 48$$

43. (C)  $5 + 3 = 8 + 4 = \boxed{12}$

$$12 + 1 = 13$$

∴ We have **? = 12**

44. (B) Here, we have series of two numbers.

1, 2, 3, 4, 5, 6, and **14**, 15, 16, 17, 18, 19

45. (A)                      46. (D)

47. (D)  $0 \times 1 \times 2 \dots \dots \times 9 = 0$

Which is none of these

48. (D)                      49. (A)                      50. (C)

51. (B) The required remainder =  $(4 \times 5) \div 7$   
So, remainder will be 6

52. (A)  $\sqrt{\frac{x}{y}} + \sqrt{\frac{y}{x}} = \frac{10}{3}$

$$\frac{x+y}{\sqrt{xy}} = \frac{10}{3} \Rightarrow \frac{10}{\sqrt{xy}} = \frac{10}{3}$$

$$xy = 9$$

53. (C) Let their present age be  $x$  and  $y$  year

$$\frac{x-4}{y-4} = \frac{2}{3}$$

$$3x - 12 = 2y - 8$$

$$3x - 2y = 4 \quad \dots(i)$$

$$\frac{x+4}{y+4} = \frac{5}{7}$$

$$7x + 28 = 5y + 20$$

$$7x - 5y = -8 \quad \dots(ii)$$

From eq. (i)  $\times 5$  & eq. (ii)  $\times 2$

$$15x - 10y = 20$$

$$14x - 10y = -16$$

$$\begin{array}{r} - \quad + \quad + \\ \hline x = 36 \text{ years} \end{array}$$

And  $y = 52$  years

54. (B) Let number of boys = B, and Girls = G



65.(A)  $R = \frac{6-1}{3-1} \times 5 = 12.5\%$

66.(D) H.C.F. of  $\frac{30}{10}, \frac{12}{10}, \frac{6}{100}$   
 $= \frac{\text{H.C.F. of } 30, 12 \text{ and } 6}{\text{L.C.M. of } 10, 10, 100} = \frac{6}{100} = 0.06$

67.(A)  $\text{cosec}^4\alpha = 17 + \cot^4\alpha$   
 $\Rightarrow \text{cosec}^4\alpha - \cot^4\alpha = 17$   
 $\Rightarrow (\text{cosec}^2\alpha - \cot^2\alpha)(\text{cosec}^2\alpha + \cot^2\alpha) = 17$   
 $\Rightarrow 1 \times \left(\frac{1+\cos^2\alpha}{\sin^2\alpha}\right) = 17$   
 $\Rightarrow 1 + 1 - \sin^2\alpha = 17 \sin^2\alpha$   
 $\Rightarrow 2 = 18 \sin^2\alpha$   
 $\Rightarrow \sin^2\alpha = \frac{2}{18} = \frac{1}{9}$   
 $\Rightarrow \sin\alpha = \frac{1}{3}$

68.(A)

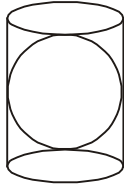

Let the height of the cylinder =  $h$   
 Then,

$$\text{radius} = \frac{h}{2}$$

Also, radius of sphere,  $r = \frac{h}{2}$

$\therefore$  Volume of cylinder =  $\pi \left(\frac{h}{2}\right)^2 \times h$   
 $= \frac{\pi \times h^3}{4}$

And Volume of sphere  $S = \frac{4}{3} \pi \times \frac{h^3}{8}$   
 Volume of remaining material

$$S_1 = \frac{\pi h^3}{4} - \frac{\pi h^3}{6}$$

$$\frac{4}{3} \pi R^3 = \frac{\pi h^3}{12}$$

$$R^3 = \frac{h^3}{16} \Rightarrow R = \frac{h}{\sqrt[3]{16}} = \frac{h}{2\sqrt[3]{2}}$$

Required ratio =  $\frac{r}{R} = \frac{\frac{h}{2}}{\frac{h}{2\sqrt[3]{2}}}$

$$r : R = \frac{1}{2\sqrt[3]{2}} : 1$$

69.(D) Total number of vote =  $1136 + 7636 + 11628$   
 $= 20400$

Required percentage =  $\frac{11628}{20400} \times 100$   
 $= 57\%$

70.(A)  $\frac{1}{1+\sqrt{2}+\sqrt{3}} + \frac{1}{1-\sqrt{2}+\sqrt{3}}$   
 $\Rightarrow \frac{1+\sqrt{3}-\sqrt{2}+1+\sqrt{3}+\sqrt{2}}{(1+\sqrt{3})^2 - (\sqrt{2})^2} = \frac{2(1+\sqrt{3})}{2(1+\sqrt{3})}$   
 $= 1$

71.(C) If  $a + b + c = 0$ , then,  $a^3 + b^3 + c^3 = 3abc$   
 $\Rightarrow \frac{a^2}{bc} + \frac{b^2}{ca} + \frac{c^2}{ab} = \frac{a^3}{abc} + \frac{b^3}{abc} + \frac{c^3}{abc}$   
 $\frac{a^3 + b^3 + c^3}{abc} = \frac{3abc}{abc} = 3$

72.(A) Let the price of table be  $t$  and chair be  $c$   
 $4t + 5c = 1000$

$$4 \times \left(t \times \frac{110}{100}\right) + 5 \times \left(c \times \frac{120}{100}\right) - (4t + 5c) = 120$$

$$\frac{44t}{10} - 4t + \frac{30c}{5} - 5c = 120$$

$$\frac{4t}{10} + c = 120$$

$$4t + 10c = 1200$$

$$4t + 5c = 1000$$

$$\begin{array}{r} - \\ - \\ - \\ \hline 5c = 200 \\ c = ₹ 40 \end{array}$$

$\therefore t = ₹ 200$

73.(C)  $S = \frac{D}{t}$   
 $(80 + 55) = \frac{65}{t}$   
 $\Rightarrow t = \frac{65}{135} = \frac{13}{27}$  hrs  
 $\Rightarrow t = \frac{13}{27} \times 60$   
 $= \frac{13 \times 20}{9}$  minutes

$\Rightarrow$  Two minutes before =  $\left(\frac{260}{9} - 2\right)$   
 $= \frac{242}{9}$  minutes

$\Rightarrow$  Distance travelled by both train in  $\frac{242}{9}$  minutes =  $135 \times \frac{242}{9 \times 60} = 60.5$  km  
 Required distance =  $(65 - 60.5)$  km  
 $= 4.5$  km

74.(B) Principal =  $P$ , rate of interest =  $\frac{r}{k}\%$  p.a.

$$A = P \left(1 + \frac{r}{k \times 100}\right)^{nk}$$

75.(D)

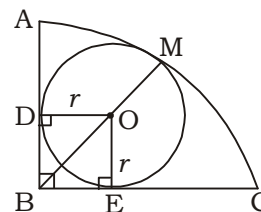

Let  $r$  is the radius of small circle.

$$\angle D = \angle E, \angle B = 90^\circ$$

So,  $\angle DOE$  must be  $90^\circ$

Hence,  $BEOD$  is a square

$$OB = \sqrt{2}r, BM = p$$

$$\Rightarrow OB = p - r = \sqrt{2}r$$

$$p = r(\sqrt{2} + 1)$$

$$\Rightarrow r = \frac{p}{\sqrt{2} + 1} = p(\sqrt{2} - 1)$$

$$76.(A) \sin^2 0^\circ = (0)^2, \quad \sin^2 \frac{\pi}{6} = \left(\frac{1}{2}\right)^2 = \frac{1}{4}$$

$$\sin^2 \frac{\pi}{4} = \left(\frac{1}{\sqrt{2}}\right)^2 = \frac{1}{2}, \quad \sin^2 \frac{\pi}{3} = \left(\frac{\sqrt{3}}{2}\right)^2 =$$

$$\frac{3}{4}$$

$$\sin^2 \frac{\pi}{2} = (1)^2 = 1$$

So,  $0, \frac{1}{4}, \frac{1}{2}, \frac{3}{4}, 1$  are in A.P.

$$77.(D) \quad P \Rightarrow 50 \quad 1 \quad 2$$

$$\text{Ratio of No.} \Rightarrow \frac{2}{3} \quad \frac{1}{3} \quad \frac{2}{4}$$

$$\text{Ratio of value} 1 : 3 : 8 \Rightarrow 12 \xrightarrow{\times 80} 960$$

$$\text{No. of coins} \Rightarrow 2 + 3 + 4 = 9 \xrightarrow{\times 80} 720$$

$$78.(C) \sqrt{\operatorname{cosec} \alpha \cdot \operatorname{cosec} \beta} \left( \frac{\sin \alpha}{\sin \beta} + \frac{\cos \alpha}{\cos \beta} \right)^{\frac{1}{2}}$$

$$= \left( \frac{1}{\sin \alpha \cdot \sin \beta} \right)^{\frac{1}{2}} \times \left( \frac{\sin \alpha \cdot \cos \beta + \cos \alpha \cdot \sin \beta}{\sin \beta \times \cos \beta} \right)^{\frac{1}{2}}$$

$$= \left( \frac{1}{\sin \alpha \cdot \sin \beta} \right)^{\frac{1}{2}} \times \left( \frac{\sin(\alpha + \beta)}{\cos(90^\circ - \alpha) \sin \beta} \right)^{\frac{1}{2}}$$

$$= \left( \frac{1}{\sin \alpha \cdot \sin \beta} \right)^{\frac{1}{2}} \times \left( \frac{\sin 90^\circ}{\sin \alpha \cdot \sin \beta} \right)^{\frac{1}{2}}$$

$$= \left( \frac{1}{\sin \alpha \cdot \sin \beta} \right)^{\frac{1}{2}} \times \left( \frac{1}{\sin \alpha \cdot \sin \beta} \right)^{\frac{1}{2}}$$

$$= 1$$

79.(A)

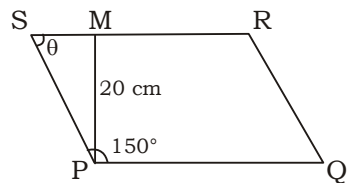

$$\angle RSP + \angle SPQ = 180^\circ$$

$$\angle RSP = 180^\circ - 150^\circ = 30^\circ$$

In  $\triangle PSM$ ,

$$\sin 30^\circ = \frac{PM}{SP} \Rightarrow \frac{1}{2} = \frac{20}{SP}$$

$$SP = 40 \text{ cm}$$

or,

$$SP = PQ = 40 \text{ cm}$$

80.(B)

$$x = 2 + 2 + 2^{\frac{2}{3}} + 2^{\frac{1}{3}}$$

$$x - 2 = 2^{\frac{2}{3}} + 2^{\frac{1}{3}}$$

$$x^3 - 2^3 - 6x(x-2) = 2^2 + 2^1 + 3 \times 2^{\frac{2}{3}} \times 2^{\frac{1}{3}}(x-2)$$

$$x^3 - 8 - 6x^2 + 12x = 4 + 2 + 6x - 12$$

or,  
81.(C)

$$x^3 - 6x^2 + 6x + 12 = 6 + 8 = 14$$

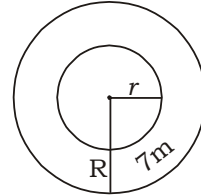

Let radius of outer circle be  $R$  and inner circle be  $r$ .

$$R - r = 7$$

$$2\pi r = 220$$

$$r = 220 \times \frac{7}{2 \times 22} = 35 \text{ m}$$

$$R = 35 + 7 = 42 \text{ m}$$

82.(A) Let the price be  $x$

$$\text{New price} = \frac{x \times 93.75}{100} = \frac{15x}{16}$$

$$\frac{120}{15x} - \frac{120}{x} = 1$$

$$120 \left( \frac{16 - 15}{15x} \right) = 1 \Rightarrow x = ₹ 8$$

$$\text{New price} = 8 \times \frac{15}{16} = ₹ 7.5$$

83.(D) C.P. of 1 banana at 1<sup>st</sup> rate = ₹  $\frac{1}{3}$

C.P. of 1 banana at 2<sup>nd</sup> rate = ₹  $\frac{1}{4}$

$$\text{Total C.P.} = \frac{1}{3} + \frac{1}{4} = ₹ \frac{7}{12} = ₹ \frac{7}{24}$$

$$\text{S.P. of 1 banana} = \frac{1}{3} - \frac{7}{24} = \frac{1}{24}$$

$$\text{Gain \%} = \left( \frac{1}{24} \div \frac{7}{24} \right) \times 100 = 14 \frac{2}{7} \%$$

84.(A) Let principal =  $P$ , rate of interest =  $R\%$

$$75 = \frac{P \times R \times 3}{100}$$

$$PR = ₹ 2500$$

$$1200 - P = \frac{P \times R \times 7}{100}$$

$$120000 - 100P = 7PR$$

$$100P = 120000 - 7 \times 2500$$

$$P = 1200 - 175 = ₹ 1025$$

$$R = \frac{2500}{1025} = 2.43\%$$

85.(D)

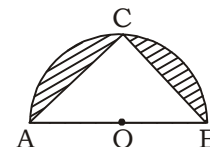

$$\text{Area of semi-circle} = \frac{\pi r^2}{2} = \frac{22}{7} \times$$

$$\frac{7 \times 7}{2} = 77 \text{ sq. cm.}$$

$$\text{Area of triangle} = \frac{1}{2} \times 14 \times 7 = 49 \text{ sq. cm}$$

$$\text{Area not occupied} = (77 - 49) \text{ sq. cm.} = 28 \text{ sq. cm}$$

86.(B)  $2(l + b)h = 520$

$$h = \frac{520}{2 \times 26} = 10 \text{ m}$$

87.(A)

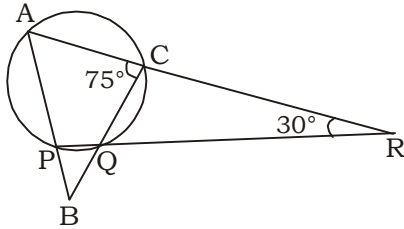

$$\Rightarrow \angle APQ = 180^\circ - 75^\circ = 105^\circ$$

[APQC is a cyclic quadrilateral]

$$\Rightarrow \angle BPQ = 180^\circ - 105^\circ = 75^\circ$$

$$\Rightarrow \angle RQC = 75^\circ - 30^\circ = 45^\circ = \angle PQB$$

$$\Rightarrow \angle B = 180^\circ - (45^\circ + 75^\circ) = 60^\circ$$

88.(B) S.I. for one year =  $\frac{225}{3} = ₹ 75$

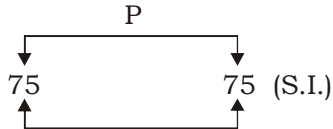

Then C.I. =  $153 - 150 = ₹ 3$

$$\text{Rate} = \frac{3}{75} \times 100 = 4\%$$

$$P \times \frac{4}{100} = 75$$

$$P = ₹ 1875$$

89.(D)  $3x - 2 = \frac{3}{x}$

$$\Rightarrow 3x^2 - 2x = 3$$

$$\Rightarrow 3(x^2 - 1) = 2x$$

$$\Rightarrow x - \frac{1}{x} = \frac{2}{3}$$

$$\Rightarrow x^2 + \frac{1}{x^2} = \left(\frac{2}{3}\right)^2 + 2 \times 1$$

$$\Rightarrow \frac{4}{9} + 2 = \frac{22}{9}$$

90.(C)

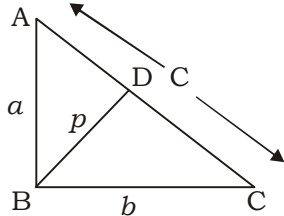

$$\Delta ABC \sim \Delta ABD$$

$$\frac{c}{a} = \frac{b}{p} \Rightarrow \frac{c}{ab} = \frac{1}{p}$$

$$\frac{1}{p^2} = \frac{c^2}{a^2 b^2} \quad [a^2 + b^2 = c^2]$$

$$\frac{1}{p^2} = \frac{a^2 + b^2}{a^2 b^2} \Rightarrow \frac{1}{p^2} = \frac{1}{a^2} + \frac{1}{b^2}$$

91.(C) Price of  $\frac{2}{5}$  books =  $7500 \times \frac{2}{5} = ₹ 3000$

$$\text{Selling price of these books} = 3000 \times \frac{85}{100} = ₹ 2550$$

Let he sells the remaining books at the rate of  $x\%$  profit

$$4500 \times \frac{100 + x}{100} = 4950$$

$$45(100 + x) = 4950$$

$$x = \frac{4950 - 4500}{45} = \frac{450}{45} = 10\%$$

92.(D) Let first number is  $4x$ , then, 2<sup>nd</sup> is  $2x$  and 3<sup>rd</sup> number is  $x$ .

$$4x + 2x + x = 60 \times 3$$

$$7x = 60 \times 3$$

$$x = \frac{180}{7}$$

$$4x = \frac{180 \times 4}{7} = \frac{720}{7}$$

93.(A)

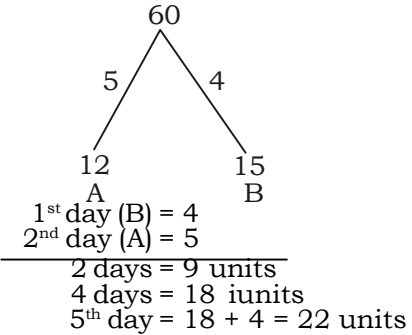

So, part of work completed =  $\frac{22}{60} = \frac{11}{30}$

94.(C)  $48m + 48n = 2880$

$$m + n = 60$$

$$\text{Average of } m + n = \frac{60}{2} = 30$$

$$\frac{1}{3} \text{ rd of average} = \frac{1}{3} \times 30 = 10$$

95.(A) A will complete in one day =  $\frac{1}{t+4}$  part

B will complete in one day =  $\frac{1}{t+64}$  part

A + B will complete in one day

$$= \frac{1}{t+4} + \frac{1}{t+64} = \frac{1}{t} \text{ part}$$

$$\Rightarrow \frac{t+64+t+4}{(t+4)(t+64)} = \frac{1}{t}$$

$$2t^2 + 68t = t^2 + 64t + 4t + 256$$

$$t^2 = 256$$

$$t = 16 \text{ minutes}$$

Short cut :

$$\text{Required time} = \sqrt{t_1 \times t_2} = \sqrt{4 \times 64}$$

$$= 16 \text{ minutes}$$

96.(A) Number of males who read at least one magazine =  $50 + 40 - 30 = 60$

Number of females who read least one magazine =  $40 + 50 - 20 = 70$

$$\text{Total} = 60 + 70 = 130$$

97.(A) Number of males and females who read only one type of magazine

**Males :**

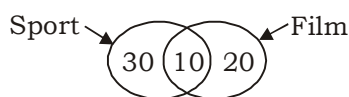

$$= 30 + 20 = 50$$

**Females :**

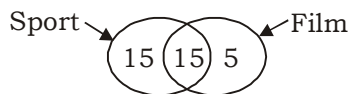

$$\Rightarrow 15 + 5 = 20$$

$$\text{Total} = 50 + 20 = 70$$

98.(C) **Males :**

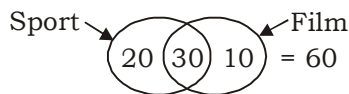

Total males who don't read either type of magazine =  $200 - 60 = 140$

**Females :**

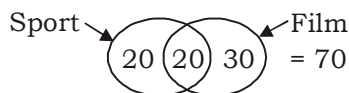

Total females who don't read either type of magazine =  $430 - 70 = 360$

$$\text{Required \%} = \frac{140 + 360}{200 + 430} \times 100$$

$$= \frac{500}{630} \times 100 = 79.36\%$$

99.(C) Total males who likes film magazine

$$= 30 + 180 + 40 = 250$$

Total females who like film magazine

$$= 20 + 100 + 50 = 170$$

$$\text{Ratio} = 250 : 170$$

$$= 25 : 17$$

100.(D) Required percentage =  $\frac{20}{430} \times 100$

$$= 4.65\%$$

101.(C) A Mahajanapada is one of the sixteen kingdoms that existed in ancient India from 6<sup>th</sup> century B.C.E. (Before the

Common Era) to 4<sup>th</sup> century C.E. (Common Era). Ancient Buddhist texts Anguttara Nikaya make reference of sixteen kingdoms which had evolved and flourished in a belt stretching from Gandhara in the northwest to Anga in the eastern part of the Indian subcontinent. Archaeologically, this period corresponds to as Northern Black Polished Ware Culture.

102.(B) **Lothal :** S. R. Rao archaeologist excavated India's top Harappan site Lothal. It is situated in Ahmedabad district in Gujarat. It is supposed to have the earliest dock in the world history. Lothal means 'mound of dead'.

**Kalibanga :** Mr. Amlanand Ghosh excavated Kalibanga in Rajasthan. Kali meas block and bangan means bangle. Terocotta bangles are excavated here.

**Chanhudaro :** N. G. Majumdar excavated Chanhudaro in Sindh, Pakistan. It was the major centre of production for the beautiful seals.

**Mohenjodaro :** Rakhal Das Banerjee excavated Mohenjodaro in Larkana district of Sind (Pakistan). Important public place of it was Great bath for ritual bathing.

103.(C) Black hole of Calcutta incident took place on 20<sup>th</sup> June, 1756 in which a number of Europeans were imprisoned in Calcutta and many died because the Nawab of Bengal, Siraj-ud-Daullah, held British prisoners of war after the capture of the Fort William.

104.(D) Baking Soda should not be used while cooking because it destroys number of nutrients, such as Vitamin C, Vitamin D, Riboflavin, Thiamine and essential amino acids.

106.(B) Oxalic acid and Oxalates are useful as reducing agents for photography, bleaching and rust removal.

107.(B) The laser printer in a few years became the dominant mode of printing in various offices. It uses a semiconductor laser and the xerography principle. The laser is focused and scanned across a photoactive Selenium coated drum where it produces a charge pattern which mirrors the material to be printed.

108.(D) NAG is a third generation 'fire-and-forget' anti-tank missile developed in India. It is one of five missile systems developed by Defence Research and Development Organisation (DRDO) under the Integrated Guided Missile Development Programme (IGMDP).



- 109.(A) The Indian Income Tax is direct and progressive. Progressive tax is the taxing mechanism in which the taxing authority charges more taxes as the income of the taxpayer increases.
- 110.(C) Terminator technology refers to plants that have been genetically modified to render sterile seeds at harvest. It is also known as Genetic Use Restriction Technologies or GURTs. The Indian Government banned the import of Terminator seeds as it would threaten traditional crops and put the well being of Indian farmers at risk. The technology would have serious implications on the crop biodiversity. It may lead to gradual extinction of traditional varieties. Inserting terminator genes into crops would prevent them from producing fertile seeds.
- 111.(B) The Indirect tax in India is a complex system of interconnecting laws and regulations, which includes specific laws of different states. The Indirect taxes levied by the Centre are customs, excise and central sales tax and the major indirect taxes levied by the states and civic bodies are passenger and goods tax, electricity duty and octroi.
- 112.(B) **Tax Haven** : A country offering very favourable tax laws for foreign businesses and individuals i.e. no tax liability in a politically and economically stable environment. It also provide little or no financial information to foreign tax authorities.
- 113.(A) The Maya are an indigenous people of Mexico and Central America who have continuously inhabited the lands. They come from the ancient Yucaton city of Mayapan, the last capital of Mayan Kingdom in the post-classic period. Their main occupation was agriculture.
- 114.(D) **Horse Latitudes** : The latitudes, approximately 30°N and S, forming the edges of the trade-wind belt, characterized by high atmospheric pressure with calms and light variable winds.
- 115.(D) Rewa is in Madhya Pradesh and is nearest to IST.  
IST (Indian Standard Time) is 5 : 30 hours ahead of Coordinated Universal Time (UTC). This time zone is a Standard Time Zone and is used in Asia. Indian Standard Time is a half-hour time zone. Its local time differs by 30 minutes from the usual one-hour time zone interval. This time zone is also called Indian Time.
- 116.(D) Attorney General of India is appointed by the President of India under Article 76(1) of the Constitution and holds office during the pleasure of the President. He must be a person qualified to be appointed as a Judge of the Supreme Court. He advises the Government of India on legal matters assigned by the President and discharge the functions conferred on him by or under the Constitution or any other law for the time being in force. He shall have the right to audience in all courts in the territory of India.
- 118.(C) The 61<sup>st</sup> Amendment Act of 1988 of the Constitution of India, lowered the voting age of elections to the Lok Sabha and to the legislative Assemblies of States from 21 to 18 years. This was done by amending Article 326 of the Constitution,
- 120.(B) Swang is a popular folk dance theatre in Rajasthan, Haryana, Uttar Pradesh and Malwa region of Madhya Pradesh. It incorporates suitable theatrics and mimicry accompanied by song and dialogue. It is basically dialogue oriented rather than movement-oriented. Religious stories and folk tales are enacted by a group of ten or twelve persons in an open area or an open-air theatre surrounded by the audience.
- 121.(D) The force between two current carrying wires give rise to the fundamental definition of the Ampere.
- 127.(D) GDP measures the domestic levels of production whereas GNP measures the levels of production of any person or corporation of a country. So, answer will be (d)
- 128.(A) Mandla is the Indian State of Madhya Pradesh. The city was the capital of Gond Dynasty. Gond queen, Rani Durgawati ruled Mandla province and fought against Akbar to save her kingdom.
- 130.(D) States touching the boundary of Myanmar are Arunachal Pradesh, Nagaland, Manipur and Mizoram.
- 131.(A) A 'Blind Valley' is a deep, narrow, flat bottomed valley with an abrupt ending. These valleys arise in limestone or Karst landscapes, where a layer of permeable rock lies above an impermeable substrate.
- 132.(D) B.R. Ambedkar, is the Chairman of Drafting Committee called Fundamental Right to Constitutional Remedies as the heart and soul of the Indian Constitution.



According to this right, a person can go to the Supreme Court in case of violation of their Fundamental Rights. According to article 32, there are 5 rights which empower the Supreme Court to enforce the Fundamental right of an individual.

They are –

- Habeas Corpus      • Mandamus
- Quo Warranto      • Certiorari
- Prohibition

137.(A) In 1799, Lord Wellesley brought the censorship of Press Act. The idea was to stop the French from publishing anything which could harm the British in anyway. This Act brought all the newspaper under the government scrutiny before the publication. This Act was later extended in 1807 and covered all kinds of press, publications, newspaper, magazine, books and pamphlets.

140.(A) On September 16, 1932, Mahatma Gandhi began 'Fast into death' to protest British support to a new Indian Constitution that would separate the Indian electorate by caste, thereby

segregating the 'untouchables' and ensuring that the social classes would remain unfairly divided.

142.(D) The Indian-American writer Akhil Sharma won second Folio Prize for fiction for a novel named "Family life".

145.(D) Hypoglycemia is also called insulin reaction. It is a condition in which blood glucose level drops too low generally below 70 mg.

146.(C) Incisors grows into tusks of an elephant, which can serve as weapons and as tools for moving objects and digging.

149.(B) Adam Smith observed that the price of diamonds was much higher than that of water even though utility of water is more than that of diamonds. This distinction of puzzle or paradox is based on the difference between marginal utility and total utility. The marginal utility of diamonds is very high and so consumers are willing to pay higher prices for diamonds, than for water.

150.(D) The Indian Judiciary, in a number of cases has effectively resorted to the writ of habeas corpus to secure release of a person from illegal detention, thereby protecting their Fundamental Right of life and liberty.

**MEANINGS IN ALPHABETICAL ORDER**

<b>Word</b>	<b>Meaning in English</b>	<b>Meaning in Hindi</b>
Apostle	Disciple or supporter of a belief or idea	प्रचारक
Apotheosis	The perfect form or example of something	श्रेष्ठ उदाहरण
Atheism	Lack of belief in the existence of God	नास्तिकता
Beat off	To repel an attack/to drive back by force	आक्रमण को विफल करना, बलपूर्वक पीछे हटा देना
Burn one's boat	To act very firmly in a way that will not allow one the opportunity to change the mind later	किसी काम को इस प्रकार प्रारंभ करना कि पीछे हटने की गुंजाइश न हो
Come across	To pass through/ To meet	से गुजरना/ मिलना
Come round	To accede to a particular opinion/To change direction	किसी दूसरे के विचार से सहमत होना / दिशा परिवर्तन करना
Come through	To do what is needed or expected	आशा के अनुरूप कार्य करना
Ecologist	One who deals with the relationships between groups of living things and their environment	पर्यावरणविद्
Efface	Destroy	नष्ट करना
Effervesce	To bubble	बुलबुला उठना
Effloresce	To burst forth/Bloom/To change in to powder	फूट जाना/ खिलना/ पाऊंडर के रूप में परिवर्तित हो जाना
Effuse	To pour out	उड़ेलना
Fall through	To come to nothing, fail of realization	व्यर्थ होना, निष्फल होना
Foment	Provoke	उकसाना
Foster	Bring up	पालन-पोषण करना
Heresy	Difference in opinion	विरुद्ध मत
Intuitive	Perceiving by intuition	अंतर्ज्ञान से जानना
Intemperate	Immoderate	असंयमी
Lackadaisical	Showing lack of interest or enthusiasm	उदासीन/ बेमन
Manifest	To make evident or certain by showing or displaying	स्पष्ट होना
Mule	A hybrid between horse and donkey	खच्चर
Nihilism	A view point that traditional value and beliefs have no value and should be destroyed	विनाशवाद
Obstetrician	A physician who delivers babies	प्रसूति विज्ञानी
Oncology	Study and treatment of cancer and tumour	कर्करोग विज्ञान
Ornate	Covered with decoration	अलंकृत
Paediatrician	A medical practitioner specializing in children and their diseases	शिशु-चिकित्सक
Part and Parcel	An essential or integral component	अंग, भाग
Paternity	Descent from father	पिता से उद्गम
Pathology	Science of diseases	रोग विज्ञान
Pedology	Soil Science	भू-विज्ञान
Peasants	Farmer	किसान
Physiatrist	A medical practioner specializing in diagnosis and treatment of mental illness	मनोरोग चिकित्सक
Pilgrim	One who travels to a holy place	तीर्थयात्री
Plod	To walk or progress slowly and usually heavily	धीरे धीरे चलना या उन्नति करना
Podgy	Short and fat	गोलमटोल
Pompous	Showy/Ornate	दिखावा करने वाला/अलंकृत
Pontoon	A flat-bottomed boat used in temporary bridge	नाव का पुल
Pragmatist	A practical approach to problems	व्यावहारिक
Refectory	A dining hall in a religious house	भोजनालय
Renegade	Disloyal	विश्वासघाती
Retreat	Movement away from a place	मोर्चा से वापस होना, छुटकारा पाना
Shattered	To break suddenly into many small pieces	ध्वस्त होना
Shilling	A British coin/ usually refers to the basic unit of money	पूर्व में उपयोग में आने वाली एक अंग्रेजी मुद्रा/ मुद्रा की सबसे छोटी इकाई
To the bitter end	Till the last	आखिरी दम तक

**SSC MOCK TEST - 8 (ANSWER KEY)**

- |         |         |         |          |          |          |          |          |
|---------|---------|---------|----------|----------|----------|----------|----------|
| 1. (C)  | 26. (A) | 51. (B) | 76. (A)  | 101. (C) | 126. (B) | 151. (B) | 176. (D) |
| 2. (C)  | 27. (B) | 52. (A) | 77. (D)  | 102. (B) | 127. (D) | 152. (C) | 177. (A) |
| 3. (C)  | 28. (C) | 53. (C) | 78. (C)  | 103. (C) | 128. (A) | 153. (D) | 178. (D) |
| 4. (A)  | 29. (A) | 54. (B) | 79. (A)  | 104. (D) | 129. (C) | 154. (A) | 179. (A) |
| 5. (C)  | 30. (C) | 55. (A) | 80. (B)  | 105. (D) | 130. (D) | 155. (D) | 180. (A) |
| 6. (A)  | 31. (D) | 56. (C) | 81. (C)  | 106. (B) | 131. (A) | 156. (A) | 181. (C) |
| 7. (B)  | 32. (B) | 57. (A) | 82. (A)  | 107. (B) | 132. (D) | 157. (D) | 182. (B) |
| 8. (A)  | 33. (B) | 58. (B) | 83. (D)  | 108. (D) | 133. (D) | 158. (A) | 183. (A) |
| 9. (B)  | 34. (B) | 59. (B) | 84. (A)  | 109. (A) | 134. (B) | 159. (B) | 184. (B) |
| 10. (A) | 35. (D) | 60. (D) | 85. (D)  | 110. (C) | 135. (D) | 160. (B) | 185. (C) |
| 11. (A) | 36. (B) | 61. (A) | 86. (B)  | 111. (B) | 136. (B) | 161. (A) | 186. (B) |
| 12. (D) | 37. (A) | 62. (A) | 87. (A)  | 112. (B) | 137. (A) | 162. (A) | 187. (A) |
| 13. (C) | 38. (D) | 63. (C) | 88. (B)  | 113. (A) | 138. (C) | 163. (B) | 188. (A) |
| 14. (D) | 39. (B) | 64. (D) | 89. (D)  | 114. (B) | 139. (B) | 164. (C) | 189. (D) |
| 15. (D) | 40. (B) | 65. (A) | 90. (C)  | 115. (D) | 140. (A) | 165. (C) | 190. (A) |
| 16. (C) | 41. (B) | 66. (D) | 91. (C)  | 116. (D) | 141. (D) | 166. (A) | 191. (C) |
| 17. (C) | 42. (B) | 67. (A) | 92. (D)  | 117. (A) | 142. (D) | 167. (A) | 192. (B) |
| 18. (A) | 43. (C) | 68. (A) | 93. (A)  | 118. (C) | 143. (A) | 168. (C) | 193. (C) |
| 19. (D) | 44. (B) | 69. (D) | 94. (C)  | 119. (D) | 144. (C) | 169. (B) | 194. (A) |
| 20. (B) | 45. (A) | 70. (A) | 95. (A)  | 120. (B) | 145. (D) | 170. (C) | 195. (B) |
| 21. (C) | 46. (D) | 71. (C) | 96. (A)  | 121. (B) | 146. (C) | 171. (A) | 196. (D) |
| 22. (B) | 47. (D) | 72. (A) | 97. (A)  | 122. (A) | 147. (B) | 172. (B) | 197. (C) |
| 23. (B) | 48. (D) | 73. (C) | 98. (C)  | 123. (D) | 148. (B) | 173. (D) | 198. (C) |
| 24. (A) | 49. (A) | 74. (B) | 99. (C)  | 124. (B) | 149. (B) | 174. (B) | 199. (A) |
| 25. (B) | 50. (C) | 75. (D) | 100. (D) | 125. (A) | 150. (D) | 175. (B) | 200. (A) |

- 151.(B); 'Just' is not needed in this sentence. 'Just' and 'exactly' used together make the sentence superfluous.
- 152.(C); Add 'there' after 'nobody'.
- 153.(D); No error
- 154.(A); Use 'Remembered' instead of 'was remembering'. 'Remember' generally doesn't take 'ing' form.
- 155.(C); Remove 'with'. 'Meet' doesn't take 'with' unless it means 'to be subjected to'.  
Eg- He met with an accident.
- 156.(A); Out-and-out means 'completely' and 'in every way'.
- 159.(B); 'Dispose' take preposition 'of' and not 'off'
- 160.(B); 'Would' expresses 'possibility' here.

**CORRECTION OF MOCK TEST-7**

46. (B) Read  as

178. (\*) The correct spelling is accommodation

**Note:- If you face any problem regarding result or marks scored, please contact 9313111777**

**Note:- If your opinion differs regarding any answer, please message the mock test and question number to 8860330003**