



KD Campus Pvt. Ltd

2007, OUTRAM LINES, 1ST FLOOR, OPPOSITE MUKHERJEE NAGAR POLICE STATION, DELHI-110009

Answer-key & Solution

SSC JE (Mechanical)
MOCK -(130)
Date:- 06/01/2018

1. D	26. C	51. B	76. C	101. C	126. A	151. D	176 D
2. C	27. B	52. C	77. B	102. B	127. C	152. D	177 C
3. D	28. A	53. C	78. A	103. C	128. C	153. D	178 A
4. B	29. C	54. C	79. A	104. C	129. C	154 A	179 B
5. C	30. B	55. C	80. B	105. B	130. D	155 D	180 C
6. C	31. C	56. B	81. B	106. D	131. C	156 B	181 C
7. C	32. B	57. A	82. A	107. D	132. C	157 A	182 D
8. C	33. D	58. A	83. C	108. D	133. D	158 D	183 B
9. C	34. C	59. B	84. C	109. A	134. C	159 B	184 C
10. A	35. D	60. A	85. D	110. A	135. A	160 B	185 A
11. D	36. C	61. A	86. B	111. C	136. B	161 A	186 A
12. B	37. C	62. B	87. D	112. D	137. B	162 B	187 D
13. A	38. C	63. A	88. A	113. A	138. D	163 C	188 B
14. A	39. A	64. D	89. A	114. C	139. A	164 B	189 D
15. C	40. D	65. A	90. C	115. D	140. C	165 D	190 A
16. A	41. B	66. C	91. C	116. B	141. C	166 D	191 D
17. B	42. A	67. C	92. A	117. B	142. C	167 C	192 A
18. A	43. D	68. A	93. D	118. B	143. C	168 A	193 A
19. B	44. D	69. A	94. B	119. D	144. B	169 D	194 D
20. C	45. D	70. D	95. C	120. B	145. A	170 D	195 C
21. A	46. C	71. A	96. D	121. B	146. C	171 C	196 B
22. A	47. C	72. A	97. D	122. A	147. B	172 D	197 B
23. A	48. C	73. C	98. A	123. C	148. C	173 D	198 D
24. D	49. A	74. C	99. D	124. B	149. C	174 D	199 B
25. D	50. C	75. B	100. C	125. A	150. B	175 C	200 C

Note : If your opinion differ regarding any answer, please message the mock test and Question number to 9821756838

Note : If you face any problem regarding result or marks scored, please contact : 9313111777

SOLUTION SSC JE (Mechanical) MOCK TEST no. 130

1. (D) Devotion is the characteristic of a monk whereas **wanderlust** is the characteristic of a Nomad.
2. (C) Slapstick results in laughter and horror results in **fear**.
3. (D) A Maestro leads an orchestra and a **skipper** leads a **crew**.
4. (B) Being erudite is a trait of a professor and being **imaginative** is a trait of an **inventor**.
5. (C) A finch is a type of bird and a Dalmatian is a type of **dog**.
6. (C) Honeybee, parrot and bat all have wings and they are capable of flying. Similarly, kangaroo, rabbit and grasshopper are all capable of hopping.
7. (C) Fly is to ant as snake is to lizard. The fly and ant both are insects similarly the snake and lizard both are reptiles.

8. (C)

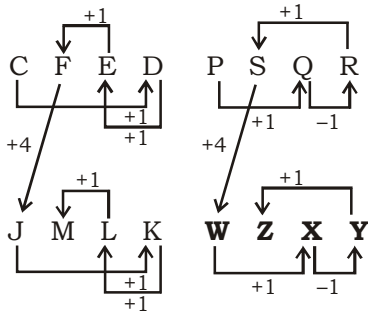

9. (C) As, $23^2 + 23 = 552$ Similarly, $30^2 + 30 = 930$

10. (A) As, $\frac{6^3 + 6^2}{2} = \frac{216 + 36}{2} = \frac{252}{2} = 126$

Similarly, $\frac{8^3 + 8^2}{2} = \frac{512 + 64}{2} = \frac{576}{2} = 288$

11. (D) In all numbers, the middle digit is sum of digits of the product of other two digits
 Now, $9 \times 2 = 18$, $1 + 8 = 9$ (middle digit in 992)
 $7 \times 3 = 21$, $2 + 1 = 3$ (middle digit in 733)
 $8 \times 5 = 40$, $4 + 0 = 4$ (middle digit in 845)
 But, $9 \times 7 = 63$, $6 + 3 = 9 \neq 4$. Hence 947 is different from others.

12. (B)

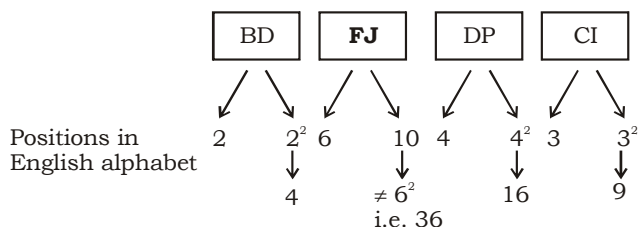

13. (A) All except Spider are flying insects.
14. (A) All except Jaipur are hill stations.
15. (A) Except Iron box, all need some type of energy to function.
16. (A) All except 63 are prime numbers.
17. (B) Except Param veer chakra, rest are civilian awards.
18. (A) Except (41-72), in other options second number is divisible by sum of the digits of the first number.
 $4 + 1 = 5$ and 72 is not divisible by 5.
 $3 + 0 = 3$ and 30 is divisible by 3,
 $5 + 1 = 6$ and 42 is divisible by 6,
 $2 + 0 = 2$ and 18 is divisible by 2.
19. (B) Given: $2 + 8 \times 16 - 4 \div 2$
 After interchanging the signs we have,
 $= 2 \times 8 - 16 \div 4 \times 2$
 $= 2 \times 8 - 4 \times 2$
 $= 16 - 8 = 8$

20. (C)

21. (A) Let the number of guests be x . Then,

The number of bowls of rice = $\frac{x}{2}$.

The number of bowls of dal = $\frac{x}{3}$.

The number of bowls of meat = $\frac{x}{4}$.

$\therefore \frac{x}{2} + \frac{x}{3} + \frac{x}{4} = 65 \Rightarrow \frac{6x + 4x + 2x}{12} = 65$

$\Rightarrow 13x = 65 \times 12$

$\Rightarrow x = \left(\frac{65 \times 12}{13} \right) = 60.$

So, the number of guests = 60.

22. (A)

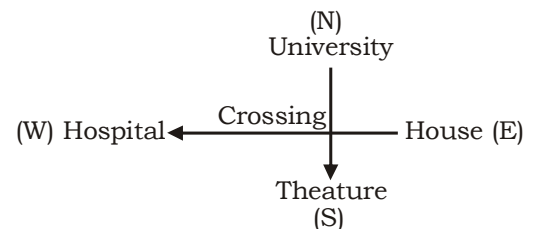

Therefore the University is in North direction.

23. (A) Hence D is the letter which is missing and it is opposite to face A.

Top face	A	B	F
Bottom face	A	E	C

24. (D)

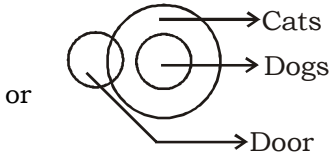
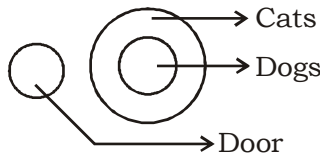

1. 5 2. 5 3. 3 4. 5

Hence, only (3) follows.

25. (D) $12 \times 8 - 7 = 96 - 7 = 89$,
 $15 \times 4 - 12 = 60 - 12 = 48$,
 $25 \times 3 - 13 = 75 - 13 = \mathbf{62}$

26. (C) $\sqrt{25 \times 9} = 5 \times 3 = 15$

and $\sqrt{36 \times 81} = 6 \times 9 = 54$

Therefore $\sqrt{16 \times 169} = 4 \times 13 = \mathbf{52}$

27. (B) $14 + 23 + 48 = 19 + 15 + 51 = 12 + 37 + \mathbf{36}$
 The sum in each case = 85.

28. (A) P @ Q → P is the wife of Q ... (i)
 Q \$ T → Q is the brother of T ... (ii)
 T # U → is the daughter of U
 Hence, Q is the son of U ... (iii)
 U * W → U is the father of W.

From (i) and (iii), we can conclude that U is the father-in-law of P.

29. (C) Father of Kamal's daughter's father → Kamal's father.
 Hence, the person is the brother of Kamal's father.
 Therefore, the person is the uncle of Kamal.

30. (B) Both Mercury and Zinc are metals.

31. (C) After Studying the pattern carefully we can observe that in the first segment, two letters face right and the next two face left. The first letter in the second segment repeats the last letter of the previous segment. The same is true for the third segment. But in the fourth segment it changes again. Here, it is opposite of the first segment, so the last two letters must face right.

32. (B) $7 + 1^2 = 8$, $8 + 2^2 = 12$, $\mathbf{12 + 3^2 = 21}$,
 $21 + 4^2 = 37$, $37 + 5^2 = 62$

33. (D) In this series, the letters remain the same i.e. DEF.

The subscript numbers follow this series :
 111, 112, 122, 222, 223, and so on.

34. (C) The first two letters PQ are common. The third letter is in alphabetical order, beginning with R and the number series is in descending order beginning with 5.

35. (D) The situation demands creating awareness among the people about the dangers of drinking polluted water so that they themselves refrain from the same and at the same time taking steps to provide safe drinking water. So, both the courses of action follow.

36. (C) Let number of horses = number of men = x

Then, number of legs = $4x + 2 \times \left(\frac{x}{2}\right) = 5x$.

So, $5x = 70$ or $x = 14$.

∴ The number of horses is 14

37. (C) Let there be (x + 1) members,

Father's share = $\frac{1}{4}$.

Share of each other member = $\frac{3}{4x}$.

∴ $3\left(\frac{3}{4x}\right) = \frac{1}{4} \Rightarrow 4x = 36 \Rightarrow x = 9$.

∴ Hence, total number of family members = 10.

38. (C)

39. (A) The figure may be labelled as shown.

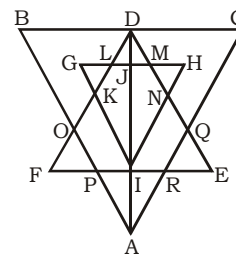

The simple triangles are GLK, DLJ, DJM, HMN, QRE, IRA, IPA and FPO i.e. 8 in number.

The triangles having two components are BDO, CDQ, DLM, PRA, KFI, NEI, HJI, GJI, DKI and DNI i.e. 10 in number.

Triangles having four components are DIE, DFI, DOA, DQA and GHI i.e. 5 in number.

Triangles having six components are DCA and DBA i.e. 2 in number.

DEF is the only triangle having eight components.

ABC is the only triangle having twelve components.

Thus, there are $8+10+ 5 + 2+1 + 1 = 27$ triangles in the figure.

40. (D) 1, 3 contain a V-shaped element inside a geometrical figure.
2, 4, 5 contain two similar elements, one placed inside the other and touching it.
6, 7 contain geometrical figures which are divided into four equal parts by two mutually perpendicular straight lines.

41. (B)

$$\begin{array}{r}
 713 \\
 \times 27 \\
 \hline
 4991 \\
 1426 \\
 \hline
 19251
 \end{array}$$

43. (D) when a cube is formed by folding the sheet shown in the question figure, then



is the one of the faces of the cube and this face lies opposite to a blank face. Also, a face bearing a square lies opposite to another blank face. The remaining two blank faces lie opposite to each other. Clearly, in the cube shown in figure (1), the face consisting of the four symbols which is not the same as that formed. Hence, the cube in figure (1) cannot be formed.

44. (D)

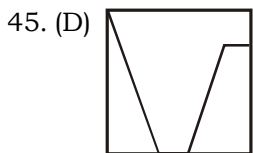

46. (C)

47. (C) The correct order is Mercury → Venus → Earth → Mars → Jupiter

48. (C) The series is $abccab / bcaabc / abccab$.

49. (A) $289 = 17^2$, $324 = 18^2$ and $361 = 19^2$.

50. (C)

52. (C) Intermediate goods and services, which are used in the production of final goods and services, are not included in the expenditure approach to GDP because expenditures on intermediate goods and services are included in the market value of expenditures made on final goods and services.

55. (C) Darul Uloom Deoband is an Islamic school where the Deobandi Islamic Movement was started. Deoband had opposed the Jinnah's Demand for the partition of British India into Muslim and Non-Muslim sections. The school advocates an orthodox version of Islam and has repeatedly distanced itself from religious extremism.

58. (A) Masonry dams are made out of masonry (mainly stone and brick). They are either the gravity or the arch type. The largest masonry dam in the world is Nagarjunasagar Dam in India which is built across Krishna River at Nagarjunasagar in Guntur and Nalgonda districts of Andhra Pradesh.

61. (A) Narsingh Mehta was a poet-saint of Gujarat, (India) and a member of the Nagar Brahmins community, notable as a bhakta, an exponent of Vaishnava poetry. He has been especially revered in Gujarati literature, where he is acclaimed as its Adi Kavi (Sanskrit form "First among Poets"). His bhajan, 'Vaishnav Jan To' was Mahatma Gandhi's favourite and had become synonymous to him. The bhajan tells us about the life, ideals and mentality of a Vaishnav Jana (A follower of Vishnu or Krishna).

66. (C) Dhanvantri is an Avatar of Vishnu in the Hindu tradition. He appears in the Vedas and Puranas as the physician of the gods (devas) and the god of Ayurvedic medicine. It is common practice in Hinduism for worshipers to pray to Dhanvantri seeking his blessings for sound health for themselves and/or others. Dhanvantri is depicted as Vishnu with four hands, holding medical herbs in one hand and a pot containing rejuvenating nectar called amrita in another. The Purans state that Dhanvantri emerged from the 'Ocean of Milk' and appeared with the pot of nectar during the story of the Samudra or Sagar manthan whilst the ocean was being churned by the devas and asuras, using the Mandara mountain and the serpent Vasuki.

68. (A) Chandra Gupra II was the third and most significant among the Gupta kings. During his reign, the famous Chinese pilgrim Fa-Hien visited India and wrote a detailed account of his kingdom. The celebrated Chinese pilgrim was struck with admiration by the famous royal palace and the houses for dispensing charity and medicine at Patliputra. He speak highly of the system of government in the Madhya desa and the benevolence of the people, especially the moneyed classes.

71. (A) An electric organizer is a small calculator-sized computer which is found often with an in-built diary application and also with few other functions such as an address book and calendar. It normally has a small alphanumeric keypad and an LCD screen of one, two or three lines.

72. (A) Power of Geyser = 1500 W = 1.5 kw
Used time = $30 \times 2 = 60$ hrs. (April = 30 days)
Energy consumed = Power \times Time
= $1.5 \times 60 = 90$ kwh
73. (C) Fossils are the remains of the dead plants or animals trapped in the layers of rocks. Coal, oil and natural gas are called fossil fuels.
75. (B) The assets of the banks are the loans and advances given to the public. Banks earn interest on these loans and advance is the main source of income for the banks.
78. (A) A medium of exchange permits the value of goods to be assessed and rendered in terms of intermediary. Most often, a form of currency widely accepted to buy any other goods.
83. (C) Ecosystem is a relationship among the living resources, habitats and residents of an area. It includes plants, trees, animals, fish, birds, micro-organisms, water, soil people, etc.
87. (D) Though temperature and humidity are key elements of weather crucial for a good harvest in Indian agriculture, it is said to be the handmaid of monsoon. This is on account of the lack of irrigational facilities across the country. A good monsoonal year often means a bumper harvest.
89. (A) The Vedas (Knowledge) are a large body of texts originating in ancient India, composed in Vedic Sanskrit. The texts constitute the oldest layer of Sanskrit literature and the oldest scriptures of Hinduism. The Vedas are apaurusheya ("not of human agency"). They are supposed to have been directly revealed, and thus are called Shruti ("What is heard"), distinguishing them from other religious texts, which are called Smriti ("What is remembered").
91. (C) Kovalam is a beach town by the Arabian Sea in Thiruvananthapuram city (Kerala). Kovalam has three beaches separated by rocky outcroppings in its 17 km coastline. The three beaches together form the famous crescent of the Kovalam beach.
93. (D) Venus can be seen with the unaided eye from Earth. It is the brightest planet in our Solar System. Venus was given the nickname evening star and morning star because of its bright consistent presence.
94. (B) Nagarjuna and Asvaghosha were the eminent Buddhist writers. Nagarjuna was the great exponent of Mahayana doctrine and Asvaghosha (a multifaceted personality) was known as a poet, musician, scholar and zealous Buddhist monk. Charaka, the most celebrated authority on Ayurveda was the court physician of Kanishka and Mathara, a politician of rare merit was his minister. Vasumitra presided over the fourth Buddhist Council.
96. (D) Human capital flight which is more commonly referred to as "brain drain" is the large-scale emigration of a large group of individuals with technically two aspects, which respectively come from countries and individuals. In terms of countries, the reasons may be social environment. In some countries it could be lack of opportunities, political instability, economic depression, health risks, etc. and in host countries it could be rich opportunities, political stability and freedom, developed economy, better living conditions, etc.
98. (A) The Chhatrapati Shivaji Maharaj Vastu Sangrahalaya (formerly Prince of Wales Museum of Western India) is the main museum in Mumbai (formerly Bombay). It was founded in the early years of the 20th century by prominent citizens of Bombay with the help of the government to commemorate the visit of the Prince of Wales.
99. (D) In computer programming, an event handler is an asynchronous call back subroutine that handles inputs received in a program. Each event is a piece of application-level information from the underlying framework, typically the GUI. GUI events include the key presses, mouse movement and action selectral concept in event-driven programming.
100. (C) Narmada is the only river in India that flows in a rift valley. It is flowing west between the Satpura and Vindhya ranges. The Tapti River and Mahi River also flow through rift valleys but between different ranges.

106. (D) $\omega^2 = g/h$
or $\omega = g/0.2$

$$\omega = \sqrt{\frac{9.81}{0.2}}$$

$$\omega = 7 \text{ rad/s}$$

109. (A) $T_{\max} = 100N$

$$T_{\min} = 60 N$$

$$b = 10\text{cm}, t = 4\text{cm}$$

$$\sigma_{\max} = \frac{T_{\max}}{b.t}$$

$$= \frac{100}{10 \times 4}$$

$$\sigma_{\max} = 2.5 N / \text{cm}^2$$

110. (A) $\frac{\pi D^2}{4} = \alpha^2$

$$I_{\text{circle}} = \frac{\pi}{64} D^4$$

$$I_{\text{square}} = \frac{\alpha^4}{12}$$

$$\frac{I_{\text{circle}}}{I_{\text{square}}} = \frac{\pi / 64 D^4}{\alpha^4 / 12}$$

$$= \frac{\pi / 64 D^4}{\frac{1}{12} \left(\frac{\pi D^2}{4} \right)^2}$$

$$= 12 \frac{\pi}{64} D^4 \cdot \frac{16}{\pi^2 D^4} = 3 / \pi$$

126. (A) $\frac{Q_1}{Q_2} = \frac{T_1}{T_2}$

$$\frac{278}{Q_2} = \frac{283 + 273}{5 + 273}$$

$$Q_2 = \frac{278 \times 276}{556}$$

$$Q_2 = 139 \text{ kw}$$

157. (A) $P = \rho g(z + z_0)$

Where z_0 is the barometric height, ρ is the density of mercury and

$$= 13,640 \text{ kg/m}^3 \times 9.8 \text{ m/sec}^2 \times (0.562 + 0.761)$$

$$= 177 \times 10^3 \text{ N/m}^3 = 1.77 \text{ kpa} = 1.77 \text{ bar}$$

159. (B) Buoyancy is defined as the upward force exerted by the fluid when the body is allowed to submerged in fluid.

171. (C)

Type of material	Number of Independent elastic constant
1. Isotropic and homogeneous	2 (E, V)
2. Orthotropic	9
3. Anisotropic	21

172. (D) $E = 2G(1 + \mu)$

$$= 2 \times 100 \times 1.25 = 250 \text{ GPa}$$

173. (D) $P_e = \frac{\pi^2 E I}{L_e^2}$

$$\frac{P_2}{P_1} = \frac{l_2}{l_1} \Rightarrow \frac{\frac{\pi}{64} d_2^4}{\frac{\pi}{64} d_1^4}$$

$$\frac{P_2}{P_1} = \left(\frac{d_2}{d_1} \right)^4$$

$$\left(\frac{0.80 D_1}{D_1} \right)^4 = 0.41$$

$$P_2 = 0.41 P_1$$

$$\text{Percentage reduction} = 59$$

192. (A) Fatigue stress concentration factor can be defined as the ratio of endurance limit without stress concentration to the endurance limit with stress concentration.

193. (A) Cotter joint is used to connect two coaxial rods which are subjected to either tensile or compressive force. It have application to join piston rod and cross head of steam engine.

198. (D) flange wrinkle is defect found in deep drawing due to this defect wrinkles are appeared in the drawn product. Flange wrinkle are appeared due to insufficient blanking holding pressure.