

SSC MOCK TEST – 61 (SOLUTION)

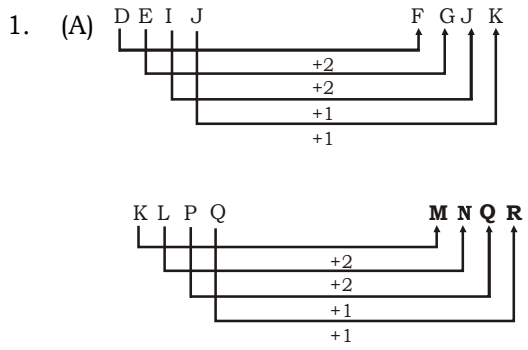

2. (D) 5 : 35 :: 7 : 77

$\times 7$ (next prime no. to 5) $\times 11$ (next prime no. to 7)

3. (A) Tadpole is transformed into **frog** and caterpillar is transformed into butterfly.

4. (A) Elated is the opposite of despondent and enlightened is the opposite of **ignorant**.

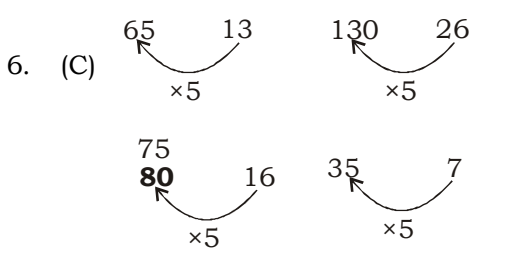
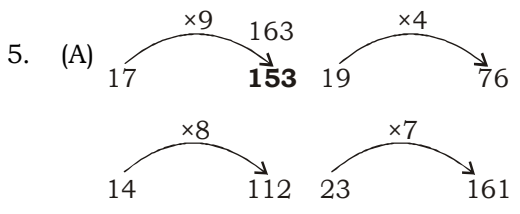

7. (B) All except river contain stagnant water.

8. (B) Except hamlet, rest are put on head.

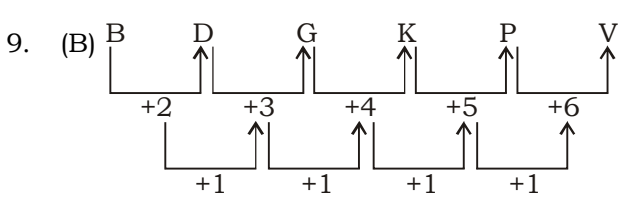

10. (C) 1 → 3 → 5 → 2 → 4

11. (A) c c b a / c c a b / c c b a / c c a b / c c b a

12. (A)

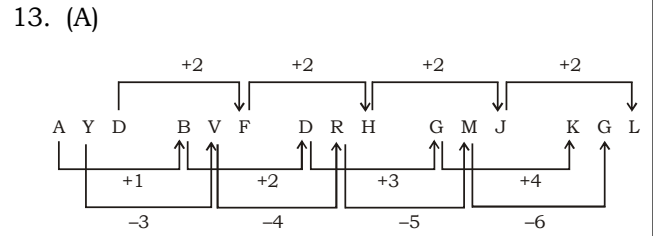

14. (A)

B	A	L	L	O	O	N
05	04	15	15	18	18	17
L	A	G	O	O	N	
15	04	10	18	18	17	

15. (C) Suresh is the father of that Boy.

16. (C) RATION

17. (B) $(6 \times 8) + (7 \times 9) = 48 + 63 = 111$
 $(5 \times 6) + (9 \times 7) = 30 + 63 = 93$
 $(6 \times 6) + (8 \times 7) = 36 + 56 = \mathbf{92}$

18. (C) $24 \times 6 = 144 \Rightarrow \frac{144}{2} = 72$

$152 \times 2 = 304 \Rightarrow \frac{304}{2} = 152$

$9 \times 18 = 162 \Rightarrow \frac{162}{2} = 81$

$\therefore ? = \mathbf{9}$

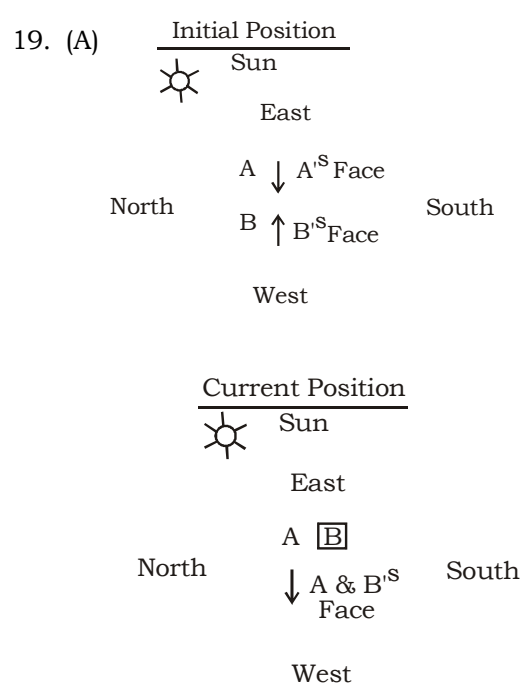

So, it is clear that both A & B are now facing towards west.

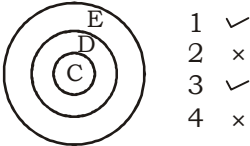
20. (B) After interchanging the signs, we have
 $40 \div 8 \times 7$
 $= 5 \times 7 = 35$
21. (B) 

1	✓
2	×
3	✓
4	×

Only (I) and (III) follows

22. (B) There are 8 corners. So, required number of cubes will always be 8.

23. (C)

24. (B)

25. (C)

26. (D) The Dholavira is the largest Indus Valley Site in independent India. It is located on Khadir Beyt, an island in the Great Rann of Kutch in Gujarat. It has been excavated by R S Bisht team of ASI. It had three citadels. Each of these three citadels of Dholavira was improved than Harappa and Mohen-jo-Daro and had an inner closure as well.

27. (B) Dadabhai Naoroji is known as mentor of both Gopal Krishna Gokhale and Mahatma Gandhi. His magnum opus "Poverty and Unbritish Rule in India" propounded the "drain theory" He was the first Indian to become a member of the House of Commons on the Liberal Party ticket. He became the president of INC thrice, in 1886, 1893 and 1906.

28. (C) India's first touch-and-feel garden for visually impaired has been inaugurated by the Kerala Assembly Speaker P Sreerama Krishnan on the Calicut University campus in Thenjipalam, Kerala. The garden with nearly 6 dozen aromatic plants will provide the visually impaired a unique opportunity of learning. They can study the plants not only by touching, feeling, smelling and tasting them, but also through audio inputs to get complete information about them.

29. (D) The World Elephant Day is observed every year on August 12th to create awareness of the urgent plight of African and Asian elephants, and to share knowledge and positive solutions for the better care and management of captive and wild elephants.

30. (C) The chemical formula for Nitrolim talc is $[Mg_2 (Si_2O_5)_2 \cdot Mg(OH)_2]$

31. (A) BCD is a binary coded notation in which each of the decimal digits is expressed as a 8-bit binary numeral. For example in binary coded decimal notation 12 is 0001 0010 as opposite to 1100 in pure binary.

32. (C) India's first repository on tigers will be set up by the Wildlife Institute of India (WII) under its new Tiger Cell at Dehradun, Uttarakhand. The cell will have a database of tigers from over 50 reserves around the country along with their DNA and stripes samples to keep a track on their numbers. If a tiger skin is recovered, the tiger cell will help in locating the area from where it came from. The purpose of the repository is to aid conservation efforts by keeping an update on tiger numbers as well as tracking poaching incidents throughout the country. The tiger cell will be funded by the National Tiger Conservation Authority (NTCA), which is a statutory body under the Ministry of Environment. It will also give clearance to development projects in areas with tiger population.

33. (A) The book "What Lies Between Us" has been authored by Nayomi Munaweera. It is a novel that sets out to explain one such crime and the possible causes behind it. It is the confession of a woman, driven by the demons of her past to commit a single and possibly unforgivable crime.

34. (B) Calcium Carbide when reacts with Nitrogen at high temperature, gives Nitrolim. It is a mixture of calcium cyanamide and carbon.

$$CaC_2 + N_2 \xrightarrow{1100^\circ C} CaCN_2 + C$$

35. (A) The unicorn is the most common motif on Indus seals and appears to represent a mythical animal that Greek and Roman sources trace back to the Indian subcontinent.

36. (D) Rourkela steel plant is the first Integrated Steel plant in the public sector in India. It was setup with German collaboration.

37. (D) Chambal river is an example of superimposed drainage. A superimposed river does not adjust with the structure of its place of origin. First of all the river valley is built on upper part and then the river develops and expands such structure in the lower part.

38. (C) The National Highways Authority of India (NHAI) has recently signed Memorandum of Understanding (MOU) with IIT-Kharagpur for research project to develop technology to construct long lasting maintenance free highways in India. IIT-Kharagpur will develop

'Paneled Cement Concrete Pavements' for highways. The duration of the research project is 3 years.

45. (C) White cement does not contain iron, hence it is white (as iron reacts with H₂O of atmosphere and forms FeS, which is black in colour).
46. (C) Agriculture continues to play the primary role in the country's development and is still the mainstay to our large growing population for its sustained food security.
47. (C) Madhya Pradesh is the only Diamond producing state and is leading producer of copper concentrate, pyrophyllite and diaspore. State hosts country's 68% diaspore, 41% molybdenum ore, 46% pyrophyllite, 32% diamond, 29% copper ore, 17% rock phosphate, 16% each of manganese ore and fireclay and 11% ochre resources.

51. (C)

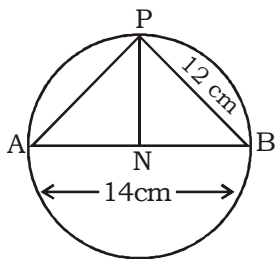

In the ΔAPB , AP can be found by pythagoras theorem.

$$AP^2 + PB^2 = AB^2 \Rightarrow AP^2 + 12^2 = 14^2 \Rightarrow AP = \sqrt{52}$$

In ΔPNB , we have

$$PN^2 = PB^2 - BN^2 \Rightarrow PB^2 - (14 - AN)^2 \quad \dots(i)$$

In ΔANP ,

$$PN^2 = AP^2 - AN^2 \quad \dots(ii)$$

Equating the eqs. (i) and (ii), we have

$$PB^2 - (14 - AN)^2 = AP^2 - AN^2$$

$$\Rightarrow 12^2 - (196 + AN^2 - 28AN) = 52 - AN^2$$

$$\Rightarrow 144 - 196 - AN^2 + 28AN = 52 - AN^2$$

$$\Rightarrow -52 + 28AN = 52$$

$$\Rightarrow 28AN = 104 \Rightarrow AN = \frac{104}{28} = \frac{26}{7} = 3\frac{5}{7}$$

$$\therefore BN = 14 - 3\frac{5}{7} = 10\frac{2}{7} \text{ cm}$$

52. (C)

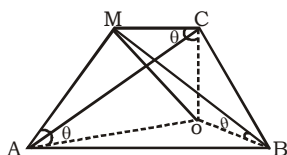

Let ABC be a scalene triangular park with the pole at 'O' stands vertically
Height of the pole = OM = h

As the angle of elevational of the top of the pole from each corner of park is same

$$\therefore \angle MAO = \angle MBO = \angle MCO = \theta$$

From ΔMAO

$$\tan \angle MAO = \frac{OM}{OA} \Rightarrow \tan \theta = \frac{OM}{OA} \quad \dots(1)$$

In ΔMBO

$$\tan \angle MBO = \frac{OM}{OB} \Rightarrow \tan \theta = \frac{OM}{OB} \quad \dots(2)$$

In ΔMCO

$$\tan \angle MCO = \frac{OM}{OC} \Rightarrow \tan \theta = \frac{OM}{OC} \quad \dots(3)$$

From equation (i), (ii) and (iii) we have

$$\frac{OM}{OA} = \frac{OM}{OB} = \frac{OM}{OC} \Rightarrow OA = OB = OC$$

It means distance of three vertices of ΔABC from point 'O' are equal.

\therefore 'O' is the circumcentre of ΔABC

53. (A)

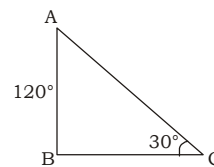

Required length (AC) = ?

$$\sin 30^\circ = \frac{AB}{AC} = \frac{120}{AC}$$

$$\Rightarrow \frac{1}{2} = \frac{120}{AC} \Rightarrow AC = 240 \text{ m}$$

54. (C) Product of two numbers = L.C.M \times H.C.F

$$\Rightarrow \frac{24 \times 1224}{72} = \text{other no.}$$

$$\Rightarrow \frac{1224 \times 1}{3} = \text{other no.} \Rightarrow \text{other no.} = 408$$

55. (B) $7a - 3b = 8a - 4b = \frac{2400}{12}$

$$\Rightarrow a = b, \text{ then } 7a - 3a = 200 \Rightarrow 4a = 200$$

$$\Rightarrow a = 50$$

$$\therefore \text{Sum of their income} = 7a + 8a = 15a = 15 \times 50 = ₹ 750$$

56. (B) Req. numbers of cube = $\frac{24 \times 12 \times 4}{(4)^3} = 18$

57. (C) $\sin(A - B) = \frac{1}{2} \Rightarrow A - B = 30^\circ$

$$\cos(A + B) = \frac{1}{2} \Rightarrow A + B = 60^\circ$$

$\Rightarrow A = 45^\circ$ and $B = 15^\circ$

$\therefore \tan 2B = \tan 30^\circ = \frac{1}{\sqrt{3}}$

58. (C) Consider length of the medians be their side's length, then multiply the result by $\frac{4}{3}$

to get the required area.

$a = 15$ cm, $b = 20$ cm, and $c = 25$ cm

$\Rightarrow S = \frac{a+b+c}{2} = 30$ cm

$\therefore \text{Area} = \sqrt{S(S-a)(S-b)(S-c)}$

$= \sqrt{30 \times 15 \times 10 \times 5} = 150$ m²

$\therefore \text{Area of } \Delta = \frac{4}{3} \times 150 = 200$ m²

59. (A)

A + B	8	}	3
B + C	12		24
C + A	8	}	3
2(A+B+C)	24		8
A+B+C	48		8

\therefore Required number of days = $\frac{48}{8} = 6$ days

60. (A) We have,

$N = (10x + y) - (10y + x)$

$\Rightarrow 10x + y - 10y - x = N$

$\Rightarrow N = 9x - 9y = 9(x - y)$

$\Rightarrow N = 9$ [$\because 9(x - y)$ is divisible by 9]

So, $N^2 - N + 1 = 9^2 - 9 + 1 = 82 - 9 = 73$

61. (A) Let x be the price of machine 3 years ago.

Its value after 1 year = $0.9x$

Its value after 2 year = $0.9x - 0.9 \times 0.1x = 0.81x$

Its value after 3 year = $0.81x \times 0.9 = 0.729x$

ATQ,

$0.729x = 7290 \Rightarrow x = 10,000$

\therefore 3 years ago, price of the machine was ₹ 10,000.

62. (B) $x^4 - 8x^2 + K = (x^2)^2 + 2(-4) \cdot x^2 + K$ (I)

Also $(a + b)^2 = a^2 + b^2 + 2ab$ (II)

Comparing both the equation we have

$a = x^2$ and $b = -4$

\therefore required value $K = b^2 = (-4)^2 = 16$

63. (B) Let ' v ' km/hr be the speed of train B

Let ' a ' km and ' b ' km be the distance of passing point from y and x respectively

As, train A travels ' b ' km

$\Rightarrow 36 = \frac{b}{4} \Rightarrow b = 144$ km

Now, time taken for both to reach the passing point will be same

$\Rightarrow \frac{a}{36} = \frac{b}{v} \Rightarrow a \times v = 36 \times 144$ (1)

Now, train B has taken 2 hrs

$\Rightarrow a = v \times 2$ (ii)

equating (1) and (II) we have

$\frac{36 \times 144}{v} = 2v$

$\Rightarrow v^2 = 36 \times 72 = v = 36\sqrt{2}$ km/hr

64. (C) Total age of players, who are replaced

= $(18 + 20)$ years = 38 years

Age of 11 players decreased by $2 \times 11 = 22$ months

Total age of new players

= 38 yrs - 22 months

= 38 years - 1 yr 10 months

= 36 yrs 2 months

\therefore Required average age = $\frac{36 \text{ yrs } 2 \text{ months}}{2}$

= 18 years 1 month

65. (B) $SI = \frac{P \times R \times T}{100}$

$\Rightarrow \frac{4}{25} P = \frac{P \times T \times T}{100}$

$\Rightarrow T = 4$ years = 48 months

66. (C) $\sqrt[3]{x} + \sqrt[3]{y} = \sqrt[3]{216}$

$\Rightarrow \sqrt[3]{64} + \sqrt[3]{y} = 6$

$\Rightarrow 4 + \sqrt[3]{y} = 6 \Rightarrow \sqrt[3]{y} = 2$

$\Rightarrow y = 2^3 = 8$

67. (D) Let CP of 8 mangoes = SP of 9 mangoes

= ₹ 72

\therefore CP of 1 mango = ₹ 9

and SP of 1 mango = ₹ 8

\therefore Loss = ₹ 1 \therefore Loss % = $\frac{1}{9} \times 100 = 11\frac{1}{9}\%$

68. (C) $4\pi r^2 = 346.5 \Rightarrow 8\pi r^2 = 346.5 \times 2$

$\Rightarrow r^2 = 27.5625 \Rightarrow r = 5.25$ cm

radius of sphere = 5.25

$\Rightarrow \frac{1}{4} * \text{diameter of circle} = 5.25$

\Rightarrow diameter of circle = 21 cm

\therefore circumference of circle = $\pi d = \frac{22}{7} \times 21$
= 66 cm

69. (B) $\left(1 - \frac{1}{2}\right)\left(1 - \frac{1}{3}\right)\left(1 - \frac{1}{4}\right) \dots \dots \left(1 - \frac{1}{49}\right)$
= $\frac{1}{2} \times \frac{2}{3} \times \frac{3}{4} \times \dots \dots \frac{47}{48} \times \frac{48}{49} = \frac{1}{49}$

70. (C) Let x be the advertised price
Given commission = 23%

\therefore SP = $x\left(1 - \frac{23}{100}\right) = 0.77x$

gain % = 10, gain = 112

CP = SP - gain \Rightarrow CP = $0.77x - 112$

Also SP = CP $\left(1 + \frac{\text{Gain}\%}{100}\right)$

$\Rightarrow 0.77x = (0.77x - 112) \times \left(1 + \frac{10}{100}\right)$

$\Rightarrow 0.77x = 0.847x - 123.2$

$\Rightarrow 0.077x = 123.2 \Rightarrow x = 1600$

\therefore Advertised price = ₹1600

71. (C) \therefore AD = CD $\Rightarrow \angle ACD = \angle DAC$

From ΔACD we have,

$\angle ACD + \angle DAC + \angle ADC = 180^\circ$

$\Rightarrow 2\angle DAC = 180 - 68 = 112^\circ$

$\Rightarrow \angle ACD = \angle DAC = 56^\circ$

Also, $\angle ACD + \angle ACB = 180^\circ \Rightarrow \angle ACB = 124^\circ$

In ΔABC , $\angle BAC = 180^\circ - (124 + 36) = 20^\circ$

72. (C) Put $x = y = z = 60^\circ$

then $\cot \frac{60}{2} + \cot \frac{60}{2} + \cot \frac{60}{2} = \cot 30^\circ +$

$\cot 30^\circ + \cot 30^\circ$

= $\sqrt{3} + \sqrt{3} + \sqrt{3} = 3\sqrt{3}$

Also, $\cot \frac{x}{2} \cdot \cot \frac{x}{2} \cdot \cot \frac{x}{2} = \sqrt{3} \cdot \sqrt{3} \cdot \sqrt{3}$

= $3\sqrt{3}$

So, $\cot \frac{x}{2} + \cot \frac{y}{2} + \cot \frac{z}{2}$

= $\cot \frac{x}{2} \cdot \cot \frac{y}{2} \cdot \cot \frac{z}{2}$

73. (B) Let the required percentage be x
then, we have

$108 + 108 \times \frac{x}{100} = 144$

$\Rightarrow \frac{108x}{100} = 36$

$\Rightarrow x = \frac{100}{3} = 33\frac{1}{3}\%$

74. (D) Milk + Tea + coffee = $108^\circ + 54^\circ + 36^\circ = 198^\circ$

Required fraction = $\frac{198^\circ}{360^\circ} = \frac{11}{20}$

\therefore Req. number of people = $\frac{11}{20} \times 1000 = 550$

75. (B) Req. diff. (in degree) = $108^\circ - 36^\circ = 72^\circ$

Required difference (in fraction) = $\frac{72^\circ}{360^\circ} = \frac{1}{5}$

\therefore Required no. of people = $1000 \times \frac{1}{5} = 200$

\therefore 23% of the result = $\frac{200 \times 23}{100} = 46$

MEANINGS IN ALPHABETICAL ORDER

Word	Meaning in English	Meaning in Hindi
Constituents	a component part of something	संघटक
Essence	the intrinsic nature or indispensable quality of something	सारांश, मूलतत्व
Fortuitous	happening by accident or chance	आकस्मिक, अप्रत्याशित
Fuddy-duddy	a person who is old-fashioned and fussy	पुराने ख्यालातों का, रूढ़िवादी
Impute	regard something as being caused by (someone or something)	श्रेय देना
Incision	a surgical cut made in skin or flesh	चीरा
Indigence	poor, needy	गरीब, निर्धन
Insight	the capacity to gain an accurate and deep intuitive understanding of a person or thing	अर्न्तदृष्टि, सहज बोध
Intermittent	occurring at irregular intervals; not continuous or steady	रूक-रूक कर
Intimidated	Frightened or terrified	भयभीत
Mammoth	huge, very large	विशाल, बहुत बड़ा
Observance	an act performed as part of a traditional ceremony	रीति, प्रक्रिया
Ontology	the branch of metaphysics dealing with the nature of being	भौतिकी की वह शाखा जो किसी वस्तु के अस्तित्व के प्रारंभ का अध्ययन करती है।
Paradox	a person, thing or situation that has two opposite features and therefore seems strange	विरोधाभास
Perceive	come to realize or understand	अनुभव करना
Perception	the ability to see, hear, or become aware of something through the senses	अनुभूति
Permeate	spread throughout (something); pervade	व्याप्त होना



K D Campus Pvt. Ltd

2007, OUTRAM LINES, 1ST FLOOR, OPPOSITE MUKHERJEE NAGAR POLICE STATION, DELHI-110009

SSC MOCK TEST - 61 (ANSWER KEY)

- | | | | |
|---------|---------|---------|----------|
| 1. (A) | 26. (D) | 51. (C) | 76. (B) |
| 2. (D) | 27. (B) | 52. (C) | 77. (B) |
| 3. (A) | 28. (C) | 53. (A) | 78. (B) |
| 4. (A) | 29. (D) | 54. (C) | 79. (B) |
| 5. (A) | 30. (C) | 55. (B) | 80. (B) |
| 6. (C) | 31. (C) | 56. (B) | 81. (C) |
| 7. (B) | 32. (A) | 57. (C) | 82. (D) |
| 8. (B) | 33. (A) | 58. (C) | 83. (A) |
| 9. (B) | 34. (C) | 59. (A) | 84. (C) |
| 10. (C) | 35. (C) | 60. (A) | 85. (B) |
| 11. (A) | 36. (A) | 61. (A) | 86. (D) |
| 12. (A) | 37. (C) | 62. (B) | 87. (C) |
| 13. (A) | 38. (B) | 63. (B) | 88. (A) |
| 14. (A) | 39. (A) | 64. (C) | 89. (A) |
| 15. (C) | 40. (D) | 65. (B) | 90. (B) |
| 16. (C) | 41. (D) | 66. (C) | 91. (A) |
| 17. (B) | 42. (D) | 67. (D) | 92. (C) |
| 18. (C) | 43. (C) | 68. (C) | 93. (B) |
| 19. (A) | 44. (D) | 69. (B) | 94. (C) |
| 20. (B) | 45. (C) | 70. (C) | 95. (B) |
| 21. (B) | 46. (C) | 71. (C) | 96. (D) |
| 22. (B) | 47. (C) | 72. (C) | 97. (C) |
| 23. (C) | 48. (D) | 73. (B) | 98. (D) |
| 24. (B) | 49. (B) | 74. (D) | 99. (A) |
| 25. (C) | 50. (D) | 75. (B) | 100. (B) |

76. (B) Since this activity is a general truth, this sentence shall be in simple present tense. Change 'is becoming' into 'become'.
77. (B) As the subject of the sentence i.e., 'what is needed' is singular in nature, replace 'are' by 'is'.
78. (B) As the subject of the sentence is 'which', which is singular in nature. Replace 'have' by 'has'.
80. (B) 'sign' will not take a preposition after it.

81. (C) Only superlative form takes 'the' before it.
91. (A) As the sentence is in present perfect form it will take V_3 form i.e., 'widened'. It will take a preposition 'in' after it.
92. (C) 'Abstract' is an adjective that will precede noun 'concepts'.

Mock Test-60 (corrections)

77. (C) Read 'met' as 'meet'.

Note:- If you face any problem regarding result or marks scored, please contact 9313111777

Note:- If your opinion differs regarding any answer, please message the mock test and question number to 8860330003