

IBPS PO PHASE - I - 181 (SOLUTION)

REASONING

(1-5):

3 to 5 Lakh	6 to 8 Lakh	10 to 13 Lakh
D - 5 Lakh Marketing	E-8 Lakh Computer	F-12 Lakh Maths
C-3 Lakh Reasoning	A- 7 Lakh English	B-11 Lakh General Knowledge
—	-	G-10 Lakh General Awareness

1. (1) 2. (5) 3. (3)
4. (2) 5. (1)

(6 - 10):

6. (1) $A < Y = B \leq X = C \geq Z$
I. $A < C \rightarrow$ True
 $K \geq R, S \geq J \geq R$
II. $A = C \rightarrow$ False
Only conclusion I is true
7. (1) $P \leq A < R \leq J$
I. $P < J \rightarrow$ True
II. $S \geq K \rightarrow$ False
Only conclusion I is true
8. (2) $P \leq A < R = K \leq J \leq S$
I. $A > J \rightarrow$ False
II. $S > P \rightarrow$ True
Only conclusion II is true
9. (4) $P < A > S \geq T = F < D$
I. $T \geq P \rightarrow$ False
II. $D > S \rightarrow$ False
Neither conclusion I nor II is true
10. (1) $N \geq P \geq T > S$
I. $N > S \rightarrow$ True
 $O < P \leq N < L$
II. $O > L \rightarrow$ False
Only conclusion I is true

(11-15):

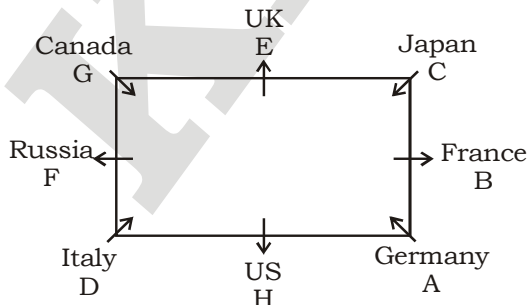

11. (1) 12. (3) 13. (5)
14. (5) 15. (1)

(16-18):

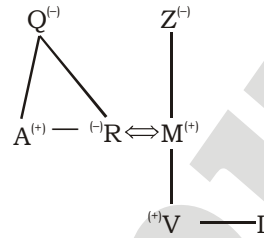

16. (2) 17. (4) 18. (5)

(19-23):

Floor	Person	Company
7	Aman	Nike
6	Ehshan	Spark
5	Bharat	Puma
4	Fazal	Reebok
3	Chetan	Woodland
2	Gaurav	Fila
1	Dayal	Adidas

19. (5) 20. (2) 21. (4)
22. (1) 23. (3)

(24-28):

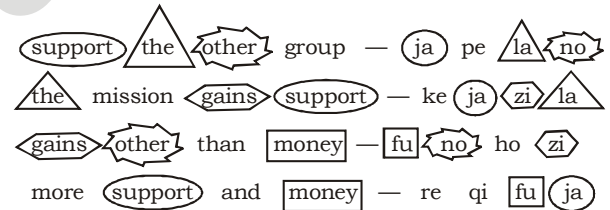

support - ja **gains - zi**
money - fu **the - la**
other - no

24. (2) 25. (5) 26. (1)
27. (3) 28. (1)

(29-30):

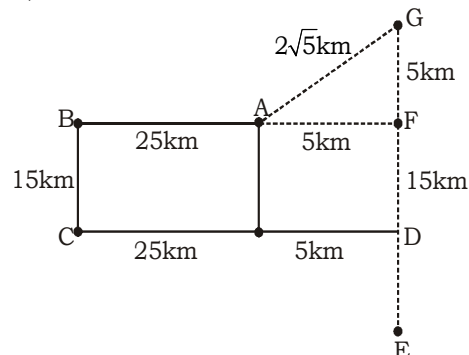

29. (3) 30. (2)

(31-35):

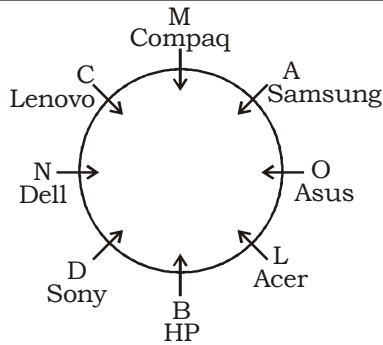

31. (4) 32. (3) 33. (4)
34. (3) 35. (2)

Maths

(36-40):

36. (5) $\sqrt{97344} = ?$
 $\Rightarrow ? = 312$
37. (4) $15 : 66 :: 185 : ?$
 $\Rightarrow \frac{15}{66} = \frac{185}{?}$
 $\Rightarrow ? = \frac{185 \times 66}{15} = 814$
38. (5) $64^{12} \div 4^{18} = 64^?$
 $\Rightarrow (4)^{3 \times 12} \div (4)^{18} = (4)^{3 \times ?}$
 $\Rightarrow (4)^{36} \div (4)^{18} = (4)^{3 \times ?}$
 $\Rightarrow 3 \times ? = 36 - 18$
 $\Rightarrow ? = \frac{18}{3} = 6$
39. (3) $3\frac{6}{7} - 6\frac{1}{4} + 5\frac{1}{3} = ?$
 $\Rightarrow ? = (3 - 6 + 5) + \left(\frac{6}{7} - \frac{1}{4} + \frac{1}{3}\right)$
 $= 2 + \left(\frac{72 - 21 + 28}{84}\right)$
 $= 2 + \frac{79}{84} = 2\frac{79}{84}$
40. (2) $14\% \text{ of } 80 + ?\% \text{ of } 90 = 31.9$
 $\Rightarrow 80 \times \frac{14}{100} + \frac{?}{100} \times 90 = 31.9$
 $\Rightarrow 11.2 + 0.9 \times ? = 31.9$
 $\Rightarrow 0.9 \times ? = 31.9 - 11.2$
 $\Rightarrow ? = \frac{20.7}{0.9} = 23$

(41-45):

41. (3) Total CP of product A = $900 + 300 = ₹1,200$
 $\therefore \text{SP} = 1200 \times \frac{105}{100} = ₹1,260$

42. (2) SP of product C = $2000 + 500 + 250 = ₹2,750$
CP of product B = $800 + 300 = ₹1,100$
 $\therefore \text{Required \%} = \left(\frac{2750}{1100} \times 100\right)\%$
 $= 250\%$

43. (2) Loss on product D = $₹\left(\frac{5000}{95} \times 5\right)$
Loss on product B = ₹300
 $\therefore \text{Required ratio} = \frac{5000 \times 5}{95} : 300$
 $= 50 : 57$

44. (2) Total CP of product E = $6000 + 400 = ₹6,400$

$\therefore \text{SP} = 6400 \times \frac{107}{100} = ₹6,848$

- SP of product C = $2000 + 500 + 250 = ₹2,750$
 $\therefore \text{Required difference} = 6848 - 2750 = ₹4,098$

45. (4) Total CP of product A = $900 + 300 = ₹1,200$

$\therefore \text{SP of product A} = 1200 \times \frac{90}{100}$

$= ₹1,080$
SP of product E = ₹6,848

$\therefore \text{Required less\%} = \left[\frac{6848 - 1080}{6848} \times 100\right]\%$
 $= 84.22\% \approx 84\%$

(46-50):

46. (5) The number series is as follows:

$2.5 + 1.5 = 4$
 $4 + 2.5 = 6.5$
 $6.5 + 3.5 = 10$
 $10 + 4.5 = 14.5$
 $14.5 + 5.5 = 20$
 $20 + 6.5 = 26.5$

47. (5) The number series is as follows:

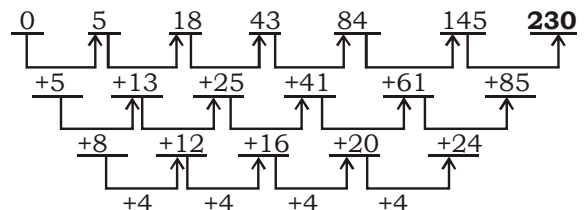

48. (2) The number series is as follows:

$14 \times 3 - 6 = 36$
 $36 \times 3 - 6 = 102$
 $102 \times 3 - 6 = 300$
 $300 \times 3 - 6 = 894$
 $894 \times 3 - 6 = 2676$
 $2676 \times 3 - 6 = 8022$

49. (4) The number series is as follows:

$$\begin{aligned} 11 + 5 &= 16 \\ 16 + 15 &= 31 \\ 31 + 25 &= 56 \\ 56 + 35 &= 91 \\ 91 + 45 &= 136 \\ \mathbf{136 + 55} &= \mathbf{192} \end{aligned}$$

50. (1) The number series is as follows:

$$\begin{aligned} 6 \times 1 + 7 \times 1 &= 13 \\ 13 \times 2 + 6 \times 2 &= 38 \\ 38 \times 3 + 5 \times 3 &= \mathbf{129} \\ 129 \times 4 + 4 \times 4 &= 532 \\ 532 \times 5 + 3 \times 5 &= 2675 \end{aligned}$$

51. (2) Let the new average of runs be x .
ATQ

$$\begin{aligned} 34(x + 2) &= 35x \\ \Rightarrow 34x + 68 &= 35x \\ \Rightarrow x &= 68 \end{aligned}$$

52. (1) 60 = Capacity of tank

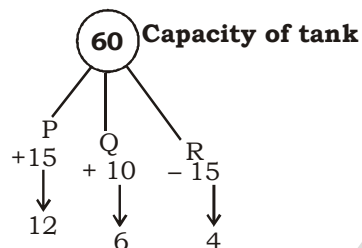

Total quantities of water in tank in 1 minute = $12 + 6 - 4 = 14$ litres

$$\begin{aligned} \therefore \text{Required time} &= \frac{60}{14} \text{ minutes} \\ &= \frac{30}{7} \text{ minutes} = 4\frac{2}{7} \text{ minutes} \end{aligned}$$

53. (1) Let the length of first train be $2x$ m.

\therefore Length of second train be x m.
ATQ.

$$\frac{x + 2x}{(93 + 51) \times \frac{5}{18}} = 24$$

$$\Rightarrow \frac{3x}{40} = 24$$

$$\Rightarrow x = \frac{40 \times 24}{3} = 320 \text{ m}$$

\therefore Length of first train = $320 \times 2 = 640$ m
Total distance covered in 66 seconds by

$$\text{first train} = 66 \times 93 \times \frac{5}{18} = 1,705 \text{ m}$$

\therefore Length of platform = $1705 - 640 = 1,065$ m

54. (3) Ratio of profit among P, Q and R
= $(42000 \times 4 + 30000 \times 6) : (30000 \times 4 + 24000 \times 6) : 28000 \times 4 + 20000 \times 6$

$$\begin{aligned} &= 348000 : (264000 : 232000) \\ &= 87 : 66 : 58 \end{aligned}$$

\therefore Profit share of R in the profit

$$= \frac{31650}{211} \times 66 = ₹9,900$$

55. (5)
(56-60):

56. (3) Required ratio = $\frac{61.2}{360} \times \frac{7}{15} : \frac{57.6}{360} \times \frac{9}{16}$
= $28.56 : 32.4 = 119 : 135$

57. (3) Required number of mobiles

$$\begin{aligned} &= 45000 \times \frac{43.2}{360} \times \frac{7}{15} \times \frac{65}{100} \\ &= 1,638 \end{aligned}$$

58. (4) Number of Samsung mobiles sold in showroom S

$$= 45000 \times \frac{28.8}{360} \times \frac{5}{12} = 1,500$$

\therefore Required cost = $1500 \times 433 = ₹6,49,500$

59. (5) Required % = $\left(\frac{\frac{61.2}{360} \times \frac{8}{15}}{\frac{57.6}{360} \times \frac{7}{16}} \times 100 \right) \%$

$$= 129.52\% \approx 130\%$$

60. (1) Required number of mobiles

$$\begin{aligned} &= \frac{45000}{360} \times \left[79.2 \times \frac{5}{9} + 90 \times \frac{2}{5} \right] \\ &= 125 \times [44 + 36] \\ &= 125 \times 80 = 10,000 \end{aligned}$$

61. (1) Principal = $\frac{30520 \times 100}{5 \times 10} = ₹61,040$

$$\begin{aligned} \text{C.I.} &= 61040 \times \frac{105}{100} \times \frac{105}{100} - 61040 \\ &= ₹6,256.60 \end{aligned}$$

62. (4) By Alligation method,

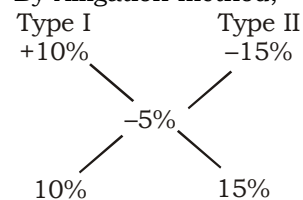

\therefore Ratio = 2 : 3

\therefore Required quantity of sugar that he sold

$$\text{at 15% loss} = \frac{300}{5} \times 3 = 180 \text{ kg}$$

63. (2) Required probability

$$= \frac{{}^8C_1 \times {}^{10}C_2}{{}^{18}C_3} = \frac{360}{816} = \frac{15}{34}$$

64. (4) Ratio between age of Ram and Karim = 2 : 3 and that of Ram and Sohan = 2 : 1
 \therefore Ratio between age of Ram, Karim and Sohan = 2 : 3 : 1
 Sum of ages of all the three at present = 75 - 15 = 60 years

\therefore Present age of Ram = $\frac{60}{6} \times 2 = 20$ years

65. (3) In Jar P, ratio between milk and water = 140 : 25 = 28 : 5
 Let the quantity of mixture taken out from Jar P = x litres,

$$\text{ATQ, } \frac{\frac{28x}{33} + 16}{\frac{5x}{33}} = \frac{21}{2}$$

$$\Rightarrow \frac{28x + 16 \times 33}{5x} = \frac{21}{2}$$

$$\Rightarrow 56x + 1056 = 105x$$

$$\Rightarrow 49x = 1056$$

$$\Rightarrow x = \frac{1056}{49} = 21.55 \text{ litres} \approx 22 \text{ litres}$$

(66-70) :

66. (5) I. $4x + 7y = 209$
 II. $12x - 14y = -38$

Equation (I) $\times 2$ + equation (II), we get
 $8x + 14y + 12x - 14y = 418 - 38$

$$\Rightarrow 20x = 380$$

$$\Rightarrow x = 19$$

Put the value of x in equation (i),

$$4 \times 19 + 7y = 209$$

$$\Rightarrow 7y = 209 - 76$$

$$y = \frac{133}{7} = 19$$

Clearly, $x = y$

67. (3) I. $17x^2 + 48x = 9$
 $\Rightarrow 17x^2 + 48x - 9 = 0$
 $\Rightarrow 17x^2 + 51x - 3x - 9 = 0$
 $\Rightarrow 17x(x + 3) - 3(x + 3) = 0$

$$\Rightarrow x = \frac{3}{17}, -3$$

- II. $13y^2 = 32y - 12$
 $\Rightarrow 13y^2 - 32y + 12 = 0$
 $\Rightarrow 13y^2 - 26y - 6y + 12 = 0$
 $\Rightarrow 13y(y - 2) - 6(y - 2) = 0$

$$\Rightarrow y = \frac{6}{13}, 2$$

Clearly, $x < y$

68. (1) I. $16x^2 + 20x + 6 = 0$
 $\Rightarrow 8x^2 + 10x + 3 = 0$
 $\Rightarrow 8x^2 + 4x + 6x + 3 = 0$
 $\Rightarrow 4x(2x + 1) + 3(2x + 1) = 0$
 $\Rightarrow x = -\frac{3}{4}, -\frac{1}{2}$

- II. $10y^2 + 38y + 24 = 0$
 $\Rightarrow 5y^2 + 19y + 12 = 0$
 $\Rightarrow 5y^2 + 15y + 4y + 12 = 0$
 $\Rightarrow 5y(y + 3) + 4(y + 3) = 0$

$$\Rightarrow y = \frac{-4}{5}, -3$$

Clearly, $x > y$

69. (4) I. $8x^2 + 6x - 5 = 0$
 $\Rightarrow 8x^2 + 10x - 4x - 5 = 0$
 $\Rightarrow 2x(4x + 5) - 1(4x + 5) = 0$
 $\Rightarrow x = \frac{1}{2}, \frac{-5}{4}$

- II. $12y^2 - 22y + 8 = 0$
 $\Rightarrow 12y^2 - 6y - 16y + 8 = 0$
 $\Rightarrow 6y(2y - 1) - 8(2y - 1) = 0$

$$\Rightarrow y = \frac{8}{6}, \frac{1}{2}$$

$$\Rightarrow y = \frac{4}{3}, \frac{1}{2}$$

Clearly, $x \leq y$

70. (2) I. $18x^2 + 18x + 4 = 0$
 $\Rightarrow 9x^2 + 9x + 2 = 0$
 $\Rightarrow 9x^2 + 6x + 3x + 2 = 0$
 $\Rightarrow 3x(3x + 2) + 1(3x + 2) = 0$
 $\Rightarrow x = \frac{-1}{3}, \frac{-2}{3}$

- II. $12y^2 + 29y + 14 = 0$
 $\Rightarrow 12y^2 + 21y + 8y + 14 = 0$
 $\Rightarrow 3y(4y + 7) + 2(4y + 7) = 0$

$$\Rightarrow y = \frac{-2}{3}, \frac{-7}{4}$$

Clearly, $x \geq y$

ENGLISH LANGUAGE

(81-85) :

81. (2) Use 'a' before 'far better'.
 82. (3) Remove 'more' before 'preferable' as it is a comparative in itself.
 83. (4) Replace first 'of' with 'in'.
 84. (5) No error
 85. (2) Replace 'about' with 'with'.

VOCABULARIES

Word	Meaning in English	Meaning in Hindi
Extended	made larger, enlarged	विस्तृत
Envisaged	ontemplate or conceive of as a possibility or a desirable future event	उल्लिखित
Depleted	use up the supply or resources of	समाप्त होना
Excursions	a short journey or trip, especially one engaged in as a leisure activity	पर्यटन
Jostling	push, elbow, or bump against (someone) roughly, typically in a crowd	ढकेलना
Hefty	large, heavy, and powerful	बलवान
Amplified	increase the volume of (sound), especially using an amplifier	प्रवर्धित
Curtailed	reduce in extent or quantity; impose a restriction on	कटौती
Colonial	of, relating to, or characteristic of a colony or colonies	औपनिवेशिक
Endeavour	an attempt to achieve a goal	प्रयास
Defend	resist an attack made on (someone or something); protect from harm or danger	बचाव
Aftermath	the consequences or aftereffects of a significant unpleasant event	परिणाम
Illusion	a thing that is or is likely to be wrongly perceived or interpreted by the senses	भ्रम
Recourse	a source of help in a difficult situation	सहारा
Revenge	the action of inflicting hurt or harm on someone for an injury or wrong suffered at their hands	बदला
Imbibing	drink (alcohol)	पी लेना
Spiritual	of, relating to, or affecting the human spirit or soul as opposed to material or physical things	आध्यात्मिक
Obsolete	no longer produced or used, out of date	अप्रचलित

KD
Campus

KD Campus

2007, OUTRAM LINES, 1ST FLOOR, OPPOSITE MUKHERJEE NAGAR POLICE STATION, DELHI-110009

IBPS PO PHASE - I - 181 (ANSWER KEY)

1. (1)	26. (1)	51. (2)	76. (5)
2. (5)	27. (3)	52. (1)	77. (2)
3. (3)	28. (1)	53. (1)	78. (1)
4. (2)	29. (3)	54. (3)	79. (4)
5. (1)	30. (2)	55. (5)	80. (3)
6. (1)	31. (4)	56. (3)	81. (2)
7. (1)	32. (3)	57. (3)	82. (3)
8. (2)	33. (4)	58. (4)	83. (4)
9. (4)	34. (3)	59. (5)	84. (5)
10. (1)	35. (2)	60. (1)	85. (2)
11. (1)	36. (5)	61. (1)	86. (3)
12. (3)	37. (4)	62. (4)	87. (1)
13. (5)	38. (5)	63. (2)	88. (5)
14. (5)	39. (3)	64. (4)	89. (2)
15. (1)	40. (2)	65. (3)	90. (2)
16. (2)	41. (3)	66. (5)	91. (3)
17. (4)	42. (2)	67. (3)	92. (1)
18. (5)	43. (2)	68. (1)	93. (5)
19. (4)	44. (1)	69. (4)	94. (3)
20. (2)	45. (4)	70. (2)	95. (5)
21. (4)	46. (5)	71. (4)	96. (1)
22. (1)	47. (5)	72. (3)	97. (3)
23. (3)	48. (2)	73. (2)	98. (2)
24. (2)	49. (4)	74. (4)	99. (5)
25. (5)	50. (1)	75. (4)	100. (4)

Note:- If you face any problem regarding result or marks scored, please contact 9313111777

Note:- Whatapp with Mock Test No. and Question No. at 7053606571 for any of te doubts. Join the group and you may also share your suggestions and experience of sunday Mock Test.

Note:- If your opinion differs regarding any answer, please message the mock test and question number to 8860330003