

SSC MOCK TEST - 290 (SOLUTION)

- (D) 'Father' is related to 'Parents', similarly 'Sister' is related to 'Sibling'.
- (D) As,

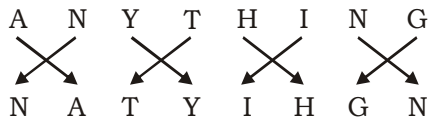

Similarly,

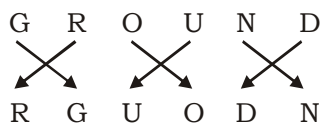

- (B) $33 : 10 :: 54 : \mathbf{21}$
 $\downarrow \quad \downarrow \quad \downarrow \quad \downarrow$
 $[(3 \times 3) + 1] \uparrow \quad [(5 \times 4) + 1] \uparrow$

- (D) $\underline{24} \ \underline{20} \Rightarrow 2^2 + 4^2 = 20$
 $\underline{35} \ \underline{34} \Rightarrow 3^2 + 5^2 = 34$
 $\underline{56} \ \underline{61} \Rightarrow 5^2 + 6^2 = 61$
 $\underline{67} \ \underline{83} \Rightarrow 6^2 + 7^2 = 85 \neq 83$

- (B)

- (D) A G
 $1 + 7 = 8$
 C E
 $3 + 5 = 8$
 B F
 $2 + 6 = 8$
 G I
 $\mathbf{7 + 9 = 16 \neq 8}$

- (B) 4. Pabloism → 2. Pacable → 3. Pachometer → 5. Pachytenes → 1. Parliamentarian

- (C) $\underline{60}, \quad \underline{80}, \quad \underline{95}, \quad \underline{105}, \quad \underline{110}$
 $\downarrow \quad \downarrow \quad \downarrow \quad \downarrow \quad \downarrow$
 $+20 \quad +15 \quad +10 \quad +5$

- (D) $\underline{AB}, \quad \underline{EFG}, \quad \underline{KLMN}, \quad \underline{STUVW}$
 $\downarrow \quad \downarrow \quad \downarrow \quad \downarrow$
 $+3 \quad +4 \quad +5$

- (C) $5 \ \& \ 8 \Rightarrow (5 - 1) \times 8 = 32$
 $9 \ \& \ 6 \Rightarrow (9 - 1) \times 6 = 48$
 $7 \ \& \ 9 \Rightarrow (7 - 1) \times 9 = \mathbf{54}$

- (B) $14^2 \times 4 = 784$
 $16^2 \times 5 = 1280$
 $12^2 \times 6 = \mathbf{864}$

12. (C)

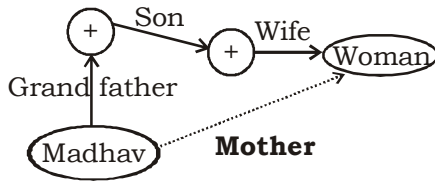

13. (D) $M > K > L$

$K > P$

$M > K > L / P > P / L > Q$

Hence, M has the maximum income.

14. (B) As,

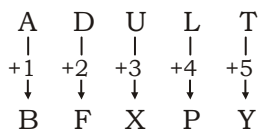

Similarly,

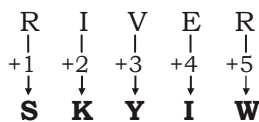

15. (B) $96 \div 4 - 6 + 11 \times 9$

After changing the signs as per the given details,

$$96 \div 4 - 6 + 11 \times 9$$

$$= 24 - 6 + 11 \times 9$$

$$= 24 - 6 + 99 = \mathbf{117}$$

16. (A)

17. (C) The word 'Solve' cannot be formed using the letters of the given word because the word 'ABSOLUTE' does not have letter 'V'.

18. (B) The number of girls in the row = $18 + 18 - 1 = 35$

19. (B)

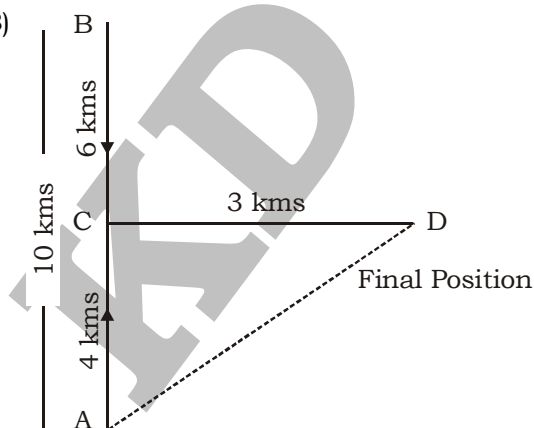

Initial Position

$$AB = 10 \text{ km}$$

$$AC = 10 - 6 = 4 \text{ km}$$

$$CD = 3 \text{ km}$$

In $\triangle ACD$,

$$AD^2 = AC^2 + CD^2$$

$$AD^2 = 4^2 + 3^2$$

$$AD = \sqrt{25} = 5 \text{ km}$$

Kusum is 5 km in north-east direction with respect to initial point.

20. (C) ~~ptxp/ptxp/ptxp/ptx~~
21. (B) 22. (A) 23. (A) 24. (C) 25. (D)
27. (A) France was the first country to implement GST to reduce tax- evasion. Since then, more than 140 countries have implemented GST with some countries having Dual-GST (e.g. Brazil, Canada etc.
28. (D) Sundari is a well known species of trees found in mangrove forests. The Sunderbans have been named after these trees.
30. (B) Isobutane, also known as i-butane, 2-methylpropane or methylpropane, is a chemical compound with molecular formula $HC(CH_3)_3$. It is an isomer of butane. Isobutane is a colourless, odourless gas.
31. (D) The Government of National Capital Territory of Delhi (Amendment) Act, 2021 has come into force in the national capital.
32. (A) The Wadiyar dynasty or Wodiyar dynasty ruled the Kingdom of Mysuru from 1399 to 1947. After getting independence from the British rule in 1947, the Kingdom of Mysuru joined in the subsequent unification of Indian dominion and princely states into the Republic of India.
33. (C) Queen Durgavati died fighting Mughal armies while defending Garha Katanga in 1564. She was the ruling Queen of Gondwana from 1550 until 1564. Khwaja Abdul Majid Asaf Khan after taking permission from Mughal emperor Akbar invaded Rani Durgavati's state.
34. (B) Dry ice, carbon dioxide in its solid form, a dense, snowlike substance that sublimates (passes directly into the vapour without melting) at -78.5°C (-109.3°F), used as a refrigerant, especially during shipping of perishable products such as meats or ice cream.
36. (B) Uniform Civil Code is defined in our Constitution under Article 44 which states that it is the duty of the state to secure for the citizens a Uniform Civil Code throughout the territory of India.
37. (D) The Chalukya dynasty was established by Pulakeshin I in 543. Pulakeshin I took Vatapi (modern Badami in Bagalkot district, Karnataka) under his control and made it his capital.
38. (B) The pituitary (puh-TOO-uh-ter-ee) gland is at the base of the brain, and is no bigger than a pea.
39. (A) During the life time of Lord Gautam Buddha, sixteen great powers (Mahajanpadas) existed in the 7th and early 6th centuries BC.
43. (A) Bahlihar Hydropower Project is located on the Chenab River in the northern Indian state of Jammu & Kashmir.
44. (C) The pupil is the opening at the center of the iris through which light passes. The iris adjusts the size of the pupil to control the amount of light that enters the eye.
45. (B) White blood cells are part of the body's immune system. They help the body fight infection and other diseases.
49. (B) Mithun is a unique domesticated bovine species raised in the Himalayan foothills of South/Southeast Asia. In India, they can be found in the North Eastern hilly regions, such as Arunachal Pradesh, Manipur, Mizoram, and Nagaland.
50. (B) Yanbu is a port city on the Red Sea coast of western part of the Saudi Arabia. Recently, a remotely piloted boat packed with explosives has been found by the kingdom near the port of Yanbu in the Red Sea.

51. (A) $8 - 3 \div 6 \text{ of } \frac{1}{2} + \left(4 \div 4 \text{ of } \frac{1}{2}\right) \div 8 + \left(4 \times 8 \div \frac{1}{4}\right) \times \frac{1}{8}$

$$= 8 - 3 \div 6 \text{ of } \frac{1}{2} + (4 \div 2) \div 8 + (4 \times 32) \times \frac{1}{8}$$

$$= 8 - 3 \div 6 \text{ of } \frac{1}{2} + 2 \div 8 + 128 \times \frac{1}{8}$$

$$= 8 - 3 \div 3 + \frac{1}{4} + 16$$

$$= 8 - 1 + \frac{1}{4} + 16$$

$$= 7 + \frac{1}{4} + 16$$

$$= \frac{28 + 1 + 64}{4} = \frac{93}{4} = 23\frac{1}{4}$$

52. (C) A can do a work in 12 days.

B can do a work in 8 days.

Let the total work = 24

$$\text{A's 1 day work} = \frac{24}{12} = 2$$

$$\text{B's 1 day work} = \frac{24}{8} = 3$$

$$\text{(A + B)'s 2 day work} = (2 + 3) \times 2 = 10$$

$$\text{Reamining work} = 24 - 10 = 14$$

Let C's 1 day work = x

ATQ,

$$\frac{14}{4} = 2 + x$$

$$14 = 8 + 4x$$

$$4x = 6$$

$$x = 1.5$$

\therefore C can do the 50% work alone in $\frac{24}{1.5} \times \frac{50}{100} = 8$ days

53. (B)

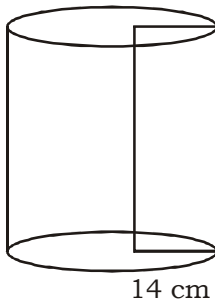

Radius of base of cylinder = 14 cm

Curved surface area of cylinder = 440 cm^2

Now,

Curved surface area of cylinder = $2\pi rh$

$$440 = 2\pi rh$$

$$440 = 2 \times \frac{22}{7} \times 14 \times h$$

$$h = \frac{440}{44 \times 2} = 5 \text{ cm}$$

\therefore Volume of cylinder = $\pi r^2 h$

$$= \frac{22}{7} \times 14 \times 14 \times 5 = 3080 \text{ cm}^3$$

54. (D) Original marked price of an article = ₹ 560

$$\text{Original cost price of an article} = \frac{560}{140} \times 100 = ₹ 400$$

Let the original selling price = ₹ x

$$\text{Original profit} = ₹ (x - 400)$$

$$\text{Now, marked price of an article after increased by 20\%} = 560 \times \frac{120}{100} = ₹ 672$$

$$\text{Selling price of an article after increased by 20\%} = x \times \frac{120}{100} = ₹ \frac{6x}{5}$$

ATQ,

$$\left(\frac{6x}{5} - 400 \right) = 2(x - 400)$$

$$6x - 2000 = 10x - 4000$$

$$10x - 6x = 4000 - 2000$$

$$4x = 2000$$

$$x = \frac{2000}{4} = ₹ 500$$

55. (A) Let the income of A and B are $4x$ and $3x$ respectively.

Let the expenditure of A and B are $3y$ and $2y$ respectively.

ATQ,

$$4x - 3y = ₹ 10000 \quad \dots(i)$$

$$3x - 2y = ₹ 10000 \quad \dots(ii)$$

Multiply equation (i) by 3 and equation (ii) by 4 and subtract, we get

$$\begin{array}{r} 12x - 9y = 30000 \\ \underline{12x - 8y = 40000} \\ y = ₹ 10000 \end{array}$$

Put the value of y in equation (i),

$$4x - 3 \times 10000 = 10000$$

$$4x = 40000$$

$$x = ₹ 10000$$

$$\begin{aligned} \therefore \text{Annual income of B} &= 3x \\ &= 3 \times 10000 = ₹ 30000 \end{aligned}$$

56. (B) Let the fourth number be x .

Average of first three numbers = $3x$

Total of three numbers = $3x \times 3 = 9x$

ATQ,

$$\frac{9x + x}{4} = 20$$

$$10x = 80$$

$$x = 8$$

57. (C) $\frac{\sin \theta + \cos \theta}{\sin \theta - \cos \theta} = \frac{3}{2}$

$$\frac{\cos \theta \left(\frac{\sin \theta}{\cos \theta} + 1 \right)}{\cos \theta \left(\frac{\sin \theta}{\cos \theta} - 1 \right)} = \frac{3}{2}$$

$$\frac{\tan \theta + 1}{\tan \theta - 1} = \frac{3}{2}$$

$$\frac{\tan \theta + 1 + \tan \theta - 1}{\tan \theta + 1 - \tan \theta + 1} = \frac{3 + 2}{3 - 2}$$

(By componendo and dividendo)

$$\frac{2 \tan \theta}{2} = \frac{5}{1}$$

$$\tan \theta = 5$$

$$\therefore \frac{\tan^2 \theta + 1}{\tan^2 \theta - 1} = \frac{(5)^2 + 1}{(5)^2 - 1} = \frac{26}{24} = \frac{13}{12}$$

58. (D) Length of first train = 180 m

$$\text{Speed of first train} = \frac{180}{15} = 12 \text{ m/s}$$

$$\text{Length of second train} = 180 \times 2 = 360 \text{ m}$$

$$\text{Let the speed of second train} = x \text{ km/s}$$

ATQ,

$$\frac{180 + 360}{12 + x} = 12$$

$$540 = 144 + 12x$$

$$12x = 396$$

$$x = \frac{396}{12} = 33 \text{ m/s}$$

59. (A) Let the sum lent out = ₹ x

ATQ,

$$\frac{x \times 12 \times 4}{100} + \frac{x \times 8 \times 4}{100} = 1260$$

$$\frac{48x + 32x}{100} = 1260$$

$$80x = 1260 \times 100$$

$$x = \frac{1260 \times 100}{80} = ₹ 1575$$

$$\therefore \text{Total sum lent out} = 1575 \times 2 = ₹ 3150$$

60. (B) Runs scored by 6 boundaries and 8 sixes = $6 \times 4 + 8 \times 6 = 72$

$$\text{Runs between wickets} = 128 - 72 = 56$$

$$\therefore \text{Required\%} = \left(\frac{56}{128} \times 100 \right) \% = 43.75\%$$

61. (A) $x^2 - 5x + 1 = 0$

Dividing both sides by x,

$$x - 5 + \frac{1}{x} = 0$$

$$x + \frac{1}{x} = 5$$

Now,

$$x^2 + x + \frac{1}{x} + \frac{1}{x^2}$$

$$= x^2 + \frac{1}{x^2} + x + \frac{1}{x}$$

$$= \left(x + \frac{1}{x} \right)^2 - 2 + \left(x + \frac{1}{x} \right)$$

$$= (5)^2 - 2 + 5 = 28$$

62. (C)

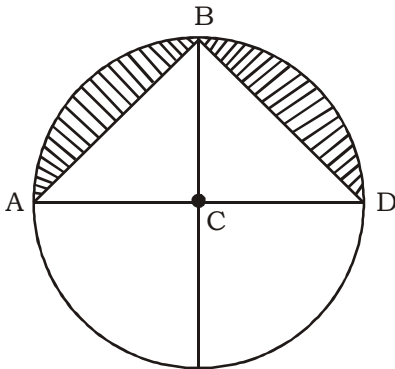

Radius of circle = a units

$$\text{Area of semi circle} = \frac{\pi a^2}{2} \text{ sq. units}$$

Both triangles $\triangle ABC$ and $\triangle DCB$ are isosceles and equal.

$$\text{Area of each triangle} = \frac{1}{2} a^2$$

$$\text{Area of both triangles} = 2 \times \frac{1}{2} a^2 = a^2 \text{ sq. units}$$

$$\therefore \text{Area of shaded region} = \frac{\pi a^2}{2} - a^2 = a^2 \left(\frac{\pi}{2} - 1 \right) \text{ sq. units}$$

63. (C)

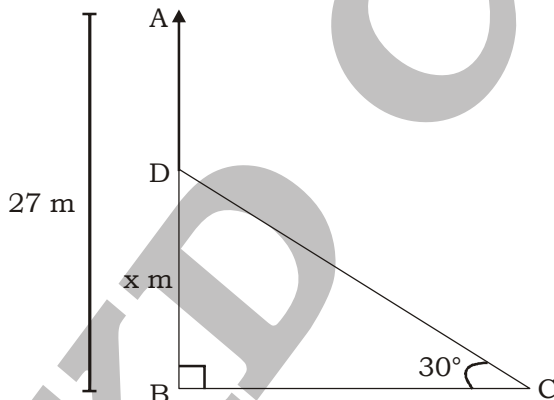

Let AB is the pole and the pole breaks at point D.

Let the height at which the pole is broken = x m

So, $BD = x$ m

and $AD = CD = (27 - x)$ m

In $\triangle ABC$,

$$\sin 30^\circ = \frac{BD}{CD}$$

$$\frac{1}{2} = \frac{x}{27 - x}$$

$$2x = 27 - x$$

$$3x = 27$$

$$x = 9 \text{ m}$$

∴ Required height = 9 m

64. (D)

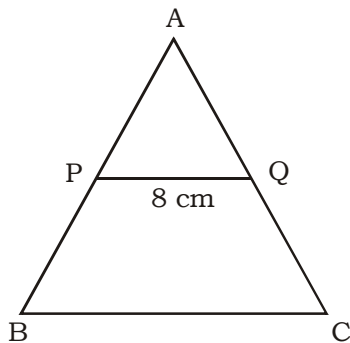

$$\overline{PQ} \parallel \overline{BC} \text{ (Given)}$$

$$\angle APQ = \angle ABC = 60^\circ$$

$$\angle AQP = \angle ACB = 60^\circ$$

So, $\triangle APQ$ is an equilateral triangle.

$$\begin{aligned} \therefore \text{Area of } \triangle APQ &= \frac{\sqrt{3}}{4} \times (PQ)^2 = \frac{\sqrt{3}}{4} \times (8)^2 \\ &= \frac{\sqrt{3}}{4} \times 64 = 16\sqrt{3} \text{ cm}^2 \end{aligned}$$

65. (B) Speed of stream = 4 km/hr

Speed of boat in still water = 6 km/hr

$$\text{Required total time to cover each 30 km in downstream and upstream} = \frac{30}{6+4} + \frac{30}{6-4}$$

$$= \frac{30}{10} + \frac{30}{2} = 3 + 15 = 18 \text{ hours}$$

66. (D) Let the each installment = ₹ x

$$\text{First installment} = \frac{x}{1 + \frac{10}{100}} = ₹ \frac{10x}{11}$$

$$\text{Second installment} = \frac{x}{\left(1 + \frac{10}{100}\right)^2} = ₹ \frac{100x}{121}$$

ATQ,

$$\frac{10x}{11} + \frac{100x}{121} = 42000$$

$$\frac{110x + 100x}{121} = 42000$$

$$210x = 42000 \times 121$$

$$x = \frac{42000 \times 121}{210} = ₹ 24200$$

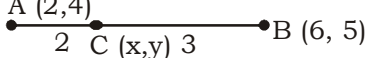
67. (A) 

Let

$$x_1 = 2 \quad x_2 = 6 \quad m_1 = 2$$

$$y_1 = 4 \quad y_2 = 5 \quad m_2 = 3$$

$$C(x, y) = \left(\frac{m_1 x_2 + m_2 x_1}{m_1 + m_2}, \frac{m_1 y_2 + m_2 y_1}{m_1 + m_2} \right)$$

$$C(x, y) = \left(\frac{2 \times 6 + 3 \times 2}{2 + 3}, \frac{2 \times 5 + 3 \times 4}{2 + 3} \right)$$

$$C(x, y) = \left(\frac{18}{5}, \frac{22}{5} \right)$$

68. (B) Let B remained in the business for x months.

ATQ,

$$36000 \times 12 : 45000 \times x = 6 : 5$$

$$\frac{36000 \times 12}{45000 \times x} = \frac{6}{5}$$

$$\frac{36 \times 12}{45 \times x} = \frac{6}{5}$$

$$45 \times x \times 6 = 36 \times 12 \times 5$$

$$x = \frac{36 \times 12 \times 5}{45 \times 6} = 8$$

Clearly B joined after $(12 - 8) = 4$ months

69. (B) $\sec\theta + \tan\theta = 3$ (i)

$$\sec^2\theta - \tan^2\theta = 1$$

$$(\sec\theta + \tan\theta)(\sec\theta - \tan\theta) = 1$$

$$3(\sec\theta - \tan\theta) = 1$$

$$(\sec\theta - \tan\theta) = \frac{1}{3} \quad \text{.....(ii)}$$

By adding equation (i) and (ii), we get

$$\sec\theta + \tan\theta + \sec\theta - \tan\theta = 3 + \frac{1}{3}$$

$$2\sec\theta = \frac{10}{3}$$

$$\therefore \sec\theta = \frac{10}{3 \times 2} = \frac{5}{3}$$

70. (C)

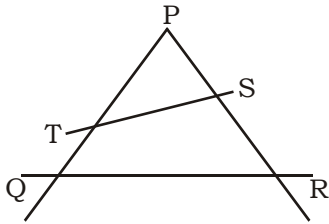

$$PT = 5, QT = 3, PS = 3$$

Let $SR = x$

$\angle PQR = \angle PST$ and $\angle P$ is common.

So, $\angle PRQ = \angle PTS$

$$\text{Hence, } \frac{PS}{PQ} = \frac{PT}{PR}$$

$$\frac{3}{5+3} = \frac{5}{3+x}$$

$$\frac{3}{8} = \frac{5}{3+x}$$

$$40 = 9 + 3x = \frac{31}{3}$$

71. (B) Corresponding angle of mean expenditure = $\frac{360^\circ}{5} = 72^\circ$

\therefore Required answer is Cement.

72. (A) Required ratio = $36 : 72 : 54 = 2 : 4 : 3$

73. (B) Highest expenditure is on Miscellaneous.

$$\therefore \text{Required percentage} = \left(\frac{108}{360} \times 100 \right) \% = 30\%$$

74. (C) Expenditure on Labour = 90°

$$\therefore \text{Required part} = \frac{90^\circ}{360^\circ} = \frac{1}{4}$$

75. (C) Total expenditure on Steel and Bricks together = $36^\circ + 54^\circ = 90^\circ$

$$\therefore \text{Required percentage} = \left(\frac{90}{360} \times 100 \right) \% = 25\%$$

MEANINGS IN ALPHABETICAL ORDER

Antagonistic	showing or feeling active opposition or hostility toward someone or something	विरोधी
Clattering	a continuous rattling sound as of hard objects falling or striking each other	चापलूसी करना
Collide	hit with force when moving	टकराना
Comply	(of a person or group) act in accordance with a wish or command	पालन करना
Cope	(of a person) deal effectively with something difficult	सामना
Cosmetics	a product applied to the body, especially the face, to improve its appearance	प्रसाधन सामग्री
Crude	in a natural or raw state; not yet processed or refined	अपरिष्कृत
Delinquent	(typically of a young person or that person's behavior) showing or characterized by a tendency to commit crime, particularly minor crime	अपराधी
Enrage	make very angry	क्रुद्ध
Hostile	unfriendly; antagonistic	शत्रुतापूर्ण
Mirage	an optical illusion caused by atmospheric conditions, especially the appearance of a sheet of water in a desert or on a hot road caused by the refraction of light from the sky by heated air	मृगतृष्णा
Numismatics	the study or collection of coins, paper currency	मुद्राशास्त्र
Pyrotechnics	a fireworks display	आतिशबाजी बनाने की विद्या
Reticent	not revealing one's thoughts or feelings readily	अल्पभाषी
Savage	(of an animal or force of nature) fierce, violent, and uncontrolled	बर्बर
Scissors	an instrument used for cutting cloth, paper, and other thin material	कैंची
Vague	of uncertain, indefinite, or unclear character or meaning	अस्पष्ट

SSC MOCK TEST - 290 (ANSWER KEY)

- | | | | |
|---------|---------|---------|----------|
| 1. (D) | 26. (B) | 51. (A) | 76. (A) |
| 2. (D) | 27. (A) | 52. (C) | 77. (B) |
| 3. (B) | 28. (D) | 53. (B) | 78. (A) |
| 4. (D) | 29. (C) | 54. (D) | 79. (A) |
| 5. (B) | 30. (B) | 55. (A) | 80. (A) |
| 6. (D) | 31. (D) | 56. (B) | 81. (B) |
| 7. (B) | 32. (A) | 57. (C) | 82. (A) |
| 8. (C) | 33. (C) | 58. (D) | 83. (C) |
| 9. (D) | 34. (B) | 59. (A) | 84. (B) |
| 10. (C) | 35. (D) | 60. (B) | 85. (D) |
| 11. (B) | 36. (B) | 61. (A) | 86. (C) |
| 12. (C) | 37. (D) | 62. (C) | 87. (B) |
| 13. (D) | 38. (B) | 63. (C) | 88. (B) |
| 14. (B) | 39. (A) | 64. (D) | 89. (C) |
| 15. (B) | 40. (B) | 65. (B) | 90. (B) |
| 16. (A) | 41. (B) | 66. (D) | 91. (B) |
| 17. (C) | 42. (C) | 67. (A) | 92. (B) |
| 18. (B) | 43. (A) | 68. (B) | 93. (C) |
| 19. (B) | 44. (C) | 69. (B) | 94. (A) |
| 20. (C) | 45. (B) | 70. (C) | 95. (B) |
| 21. (B) | 46. (B) | 71. (B) | 96. (D) |
| 22. (A) | 47. (B) | 72. (A) | 97. (B) |
| 23. (A) | 48. (B) | 73. (B) | 98. (A) |
| 24. (C) | 49. (B) | 74. (C) | 99. (B) |
| 25. (D) | 50. (B) | 75. (C) | 100. (B) |

76. (A) 'Quarter' is a noun and 'quarterly' is adjective/adverb. The noun 'results' should be preceded by adjective 'quarterly'.
77. (B) If the second event occurs immediately after the first, we can express that idea using the structure no sooner ... than. / hardly or scarcely...when./ As soon as, 'when' should be replaced with than.
90. (B) The correct spelling of 'Sweatter' is 'Sweater', 'Clettering' is 'Clattering' and 'Teribble' is 'Terrible'.
91. (B) The correct spelling is 'Mention'.