

SSC MOCK TEST - 296 (SOLUTION)

1. (B) Pragmatic is antonym of Quixotic, while Bright is antonym of Murky.
 2. (B) As, _____ Similarly,

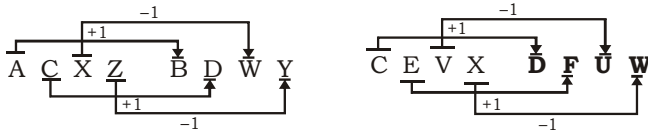

3. (D) Except Head, others are sense organs.
 4. (D) (A) $\begin{matrix} 42 & - & 33 \\ \downarrow & & \downarrow \\ 4+2=6 & & 3+3=6 \end{matrix}$
 (B) $\begin{matrix} 62 & - & 44 \\ \downarrow & & \downarrow \\ 6+2=8 & & 4+4=8 \end{matrix}$
 (C) $\begin{matrix} 46 & - & 28 \\ \downarrow & & \downarrow \\ 4+6=10 & & 2+8=10 \end{matrix}$
 (D) $\begin{matrix} 75 & - & 65 \\ \downarrow & & \downarrow \\ 7+5=12 & & 6+5=11 \end{matrix}$
 5. (C) 'WXYZ' are four consecutive letters. The same relationship is not found in others.

6. (C) $\begin{matrix} \underline{\text{CBA}} & \underline{\text{FED}} & \underline{\text{IHG}} & \underline{\text{LKJ}} & \underline{\text{ONM}} \\ \uparrow & \uparrow & \uparrow & \uparrow & \uparrow \\ +3 & +3 & +3 & +3 & +3 \end{matrix}$

7. (B) $\begin{matrix} 6 & 12 & 36 & 144 & 720 & 4320 & \mathbf{30240} \\ \uparrow & \uparrow & \uparrow & \uparrow & \uparrow & \uparrow & \uparrow \\ \times 2 & \times 3 & \times 4 & \times 5 & \times 6 & \times 7 & \end{matrix}$

8. (B) It takes 22 seconds to ring 12 dongs

$$\text{Time taken to ring 1 dong} = \frac{22}{12-1} = \frac{22}{11} = 2 \text{ seconds}$$

$$\text{Time taken to ring 6 dongs} = (6 - 1) \times 2 = 10 \text{ seconds}$$

9. (C) GREEN

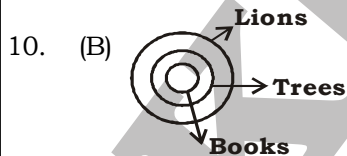

- I. True II. False III. False IV. True

Hence, only conclusions I and IV follow.

11. (B) As,

$$7 \ \& \ 2 \Rightarrow 7^2 = 49$$

$$9 \ \& \ 3 \Rightarrow 9^3 = 729$$

Similarly,

$$13 \ \& \ 3 \Rightarrow 13^3 = 2197$$

12. (C) As, T D
 $20 + 4 \Rightarrow 24 \times 2 = 48$
 and, R M
 $18 + 13 \Rightarrow 31 \times 2 = 62$
 Similarly,
 I X
 $9 + 24 \Rightarrow 33 \times 2 = \mathbf{66}$

13. (B) 3. Brain \rightarrow 4. Thyroid gland \rightarrow 2. Heart \rightarrow 5. Liver \rightarrow 1. Stomach

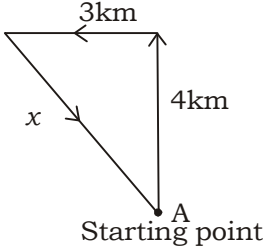
14. (C) 

$$x^2 = 4^2 + 3^2$$

$$x^2 = 16 + 9$$

$$x^2 = 25$$

$$x = 5$$

\therefore Total distance covered by her = $4 + 3 + 5 = 12$ km

15. (B)

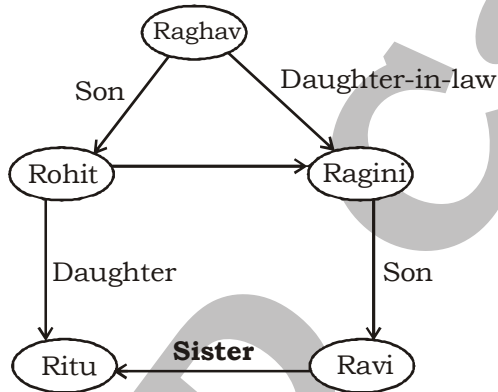

Hence, Ritu is the sister of Ravi.

16. (B) $48 \div 80 - 10 = 12 < 42 = 14$
 After changing the signs as per the given detail,
 $48 - 80 \div 10 + 12 > 42 + 14$
 $48 - 8 + 12 > 56$
 $= 52 > 56$ (wrong)

17. (C) As,
 $35 + 7 = 42$
 $42 + 5 = 47$
 Similarly,
 $43 + 7 = 50$
 $50 + 5 = 55$

18. (B)

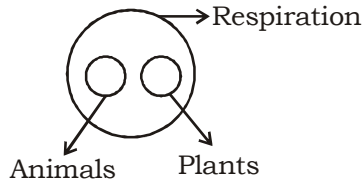

19. (C) A ← opposite → T

Q ← opposite → R

P ← opposite → Z

20. (B) bcde/edcb/bcde

21. (D) 22. (C) 23. (D) 24. (A) 25. (C)

26. (A) Article 244 (1) of the Indian Constitution defines Scheduled Areas as the areas defined so by the President of India and are mentioned in the fifth schedule of the Constitution. In India, there are 10 states having scheduled areas. Article 244 deals with the Scheduled and Tribal Areas.
27. (A) Crocodilians (alligators, caimans, crocodiles and gharials) who, like birds and mammals, have four-chambered hearts with two atria and two ventricles.
28. (A) Muvendavelan was NOT a type of sacrifice performed by kings in ancient India to establish their position. Muvendavelan was a famous military officer of the Chola Empire, known for his generous donation to the numerous temples where he had been deployed by the king.
29. (B) A leading luminary of the Ghadar Party, Kartar Singh Sarabha was executed at Lahore in November 1915 for his role in the Ghadar Conspiracy in February 1915.
30. (A) Mission Indradhanush is a health mission of the Government of India. It was launched by Union Health Minister J. P. Nadda on 25 December 2014. The scheme this seeks to drive towards 90% full immunisation coverage of India and sustain the same by year 2020.
31. (A) With Uruguay now two-time official football world champions and to celebrate their centenary of independence in 1930, FIFA named Uruguay as the host country of the inaugural World Cup tournament.
32. (D) Argon is used in light bulbs. The very thin metal filament inside the bulb would react with oxygen and burn away if the bulb were filled with air instead of argon. Argon stops the filament burning away because it is unreactive.
33. (B) The term for the irrational fear of blood is hemophobia.
36. (B) The Assam government has recently announced Chief Minister's Sishu Sewa Scheme for the welfare of those children who lost parents due to COVID-19. Monthly scholarship of Rs. 3,500 per month would be given to those children who lost their parents but have their extended family members. Free residential educational facilities would be provided to children who don't have extended family members.
39. (D) Constitution (101st Amendment) Act, 2016. In order to suitably implement the GST legislation, this Act resulted in the insertion, deletion and amendment of certain Articles of the Constitution.
40. (A) The troposphere is the lowest layer of our atmosphere.
42. (A) The International Kite Festival takes place in specially in Ahmedabad, Gujarat, India. The festival is called Uttarayan.
43. (A) The Ravi River was known as Purushni in the Vedic period. The River Ravi is a transboundary river that connects northwest India and East Pakistan. This is one of the six rivers of the Punjab Indus basin (Punjab means "five rivers").
44. (C) Pedology is 'the scientific study of soil, especially its formation, nature, and classification.
45. (A) Mitochondria are tiny organelles inside cells that are involved in releasing energy from food. This process is known as cellular respiration. It is for this reason that mitochondria are often referred to as the powerhouses of the cell.

46. (B) The JayaPrakash Narayan Interpretation Centre/ Museum of Socialism in Lucknow is built on the idea of creating public architecture.
47. (C) Gross National Product (GNP) is the total value of all finished goods and services produced by a country's citizens in a given financial year, irrespective of their location.
50. (C) The Chief Minister of Karnataka B S Yediyurappa has launched a portal named Akanksha, which would provide details on all the Corporate Social Responsibility (CSR) activities in Karnataka. This comprehensive portal would help the state Government officials, corporates and donors. It seeks to improve transparency in utilisation of CSR funds by the Government.

51. (B)

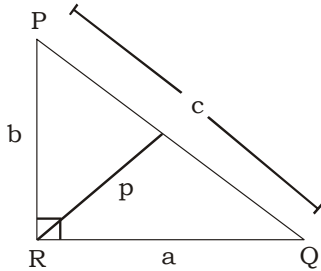

QR = a, PR = b and PQ = c (Given)

$$\text{Area of } \triangle ABC = \frac{1}{2} cp \quad \dots\dots(i)$$

$$\text{Again, area of triangle PQR} = \frac{1}{2} \times QR \times PR = \frac{1}{2} ab \quad \dots\dots(ii)$$

Equating equation (i) and (ii),

$$\frac{1}{2} \times cp = \frac{1}{2} ab$$

$$c = \frac{ab}{p} \quad \dots\dots(iii)$$

In right $\triangle PQR$,

$$PQ^2 = PR^2 + QR^2$$

$$c^2 = b^2 + a^2$$

$$\left(\frac{ab}{p}\right)^2 = b^2 + a^2 \quad \text{[using (iv)]}$$

$$\frac{a^2 b^2}{p^2} = b^2 + a^2$$

$$\frac{1}{p^2} = \frac{a^2 + b^2}{a^2 b^2}$$

$$\frac{1}{p^2} = \frac{a^2}{a^2 b^2} + \frac{b^2}{a^2 b^2}$$

$$\frac{1}{p^2} = \frac{1}{b^2} + \frac{1}{a^2}$$

$$\frac{1}{b^2} = \frac{1}{p^2} - \frac{1}{a^2}$$

52. (C) Let the cost price of one table be x and the cost price of one chair be y .

$$3x + 6y = 6000 \quad \dots(i)$$

$$3x \times \frac{115}{100} + 6y \times \frac{90}{100} = 6600$$

$$345x + 540y = 660000 \quad \dots(ii)$$

By multiplying equation (i) by 90 and subtract equation (i) from equation (ii),

$$345x + 540y - 270x - 540x = 660000 - 540000$$

$$75x = 120000$$

$$x = \frac{120000}{75} = ₹ 1600$$

∴ Cost price of one table = ₹ 1600

53. (D) $\frac{8}{9}$ of $\left(5\frac{1}{4} \div 2\frac{1}{3} \text{ of } 4\right) \div \left(8 \div \frac{2}{3} \text{ of } \frac{4}{5}\right)$ of $\left(8 \times \frac{2}{3} \div \frac{4}{5}\right)$

$$= \frac{8}{9} \text{ of } \left(\frac{21}{4} \div \frac{28}{3}\right) \div \left(8 \div \frac{8}{15}\right) \text{ of } \left(8 \times \frac{2}{3} \times \frac{5}{4}\right)$$

$$= \frac{8}{9} \text{ of } \left(\frac{21}{4} \times \frac{3}{28}\right) \div \left(8 \times \frac{15}{8}\right) \text{ of } \left(\frac{20}{3}\right)$$

$$= \frac{8}{9} \text{ of } \frac{9}{16} \div 15 \text{ of } \frac{20}{3}$$

$$= \frac{1}{2} \times \frac{1}{100} = \frac{1}{200}$$

54. (C) $\sin^2 60^\circ \cos^2 45^\circ + 4 \tan^2 30^\circ + \frac{1}{2} \sin^2 30^\circ + 2 \cos 90^\circ$

$$= \left(\frac{\sqrt{3}}{2}\right)^2 \cdot \left(\frac{1}{\sqrt{2}}\right)^2 + 4 \times \left(\frac{1}{\sqrt{3}}\right)^2 + \frac{1}{2} \times \left(\frac{1}{2}\right)^2 + 2 \times 0$$

$$= \frac{3}{4} \times \frac{1}{2} + 4 \times \frac{1}{3} + \frac{1}{2} \times \frac{1}{4} + 0 = \frac{3}{8} + \frac{4}{3} + \frac{1}{8}$$

$$= \frac{9 + 32 + 3}{24} = \frac{44}{24} = \frac{11}{6}$$

55. (B) Let the total number of students in a class be 1000.

$$\text{Number of students who did not appear for the exam} = 1000 \times \frac{4}{100} = 40$$

$$\text{Number of students who appeared for the exam} = 1000 - 40 = 960$$

$$\text{Number of appeared students who could not pass the exam} = 960 \times \frac{10}{100} = 96$$

$$\text{Remaining students who passed the exam} = 960 - 96 = 864$$

$$\text{Number of students who only passed, but couldn't get distinction marks} = 864 \times \frac{50}{100} = 432$$

ATQ,

$$432 \rightarrow 1080$$

$$\therefore 1000 \rightarrow \frac{1080}{432} \times 1000 = 2500$$

Total number of students in a school = 2500

56. (D)

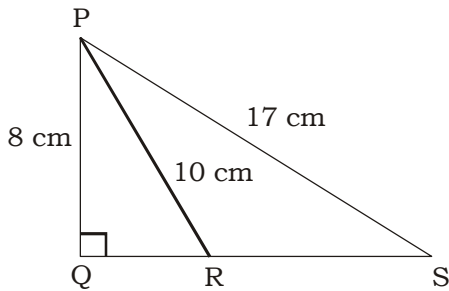

In right ΔPQR ,

$$QR = \sqrt{PR^2 - PQ^2} \quad (\text{By pythagoras theorem})$$

$$= \sqrt{10^2 - 8^2} = \sqrt{100 - 64} = \sqrt{36} = 6 \text{ cm}$$

Now, In right ΔPQS ,

$$QS = \sqrt{PS^2 - PQ^2} = \sqrt{17^2 - 8^2}$$

$$= \sqrt{289 - 64} = 15 \text{ cm}$$

$$\therefore RS = QS - QR = 15 - 6 = 9 \text{ cm}$$

57. (C) Difference of CI and SI = ₹ 432

$$\left[30000 \left(1 + \frac{R}{100} \right)^2 - 30000 \right] - \frac{30000 \times R \times 2}{100} = 432$$

Given that, P = ₹ 30000 and T = 2 years

$$30000 \left[1 + \left(\frac{R}{100} \right)^2 + \frac{2R}{100} \right] - 30000 - \frac{30000 \times R \times 2}{100} = 432$$

$$30000 + 30000 \times \frac{R^2}{10000} + \frac{30000 \times 2R}{100} - 30000 - \frac{30000 \times 2R}{100} = 432$$

$$3R^2 = 432$$

$$R^2 = 144$$

$$R = 12\%$$

58. (B) $\left(x + \frac{1}{x} \right)^3 = x^3 + \frac{1}{x^3} + 3 \times x \times \frac{1}{x} \left(x + \frac{1}{x} \right)$

$$\left(x + \frac{1}{x} \right)^3 = 52 + 3 \left(x + \frac{1}{x} \right)$$

From option (B),

if $x + \frac{1}{x} = 4$, then

$$(4)^3 = 52 + 3 \times 4$$

$$64 = 64$$

Hence, option (B) satisfies the equation.

So, correct option is 4.

59. (A) $\frac{\tan \theta}{1 + \sec \theta} - \frac{\tan \theta}{1 - \sec \theta}$

$$= \frac{\tan \theta(1 - \sec \theta) - \tan \theta(1 + \sec \theta)}{1 - \sec^2 \theta}$$

$$= \frac{\tan \theta(1 - \sec \theta - 1 - \sec \theta)}{-(\sec^2 \theta - 1)}$$

$$= \frac{\tan \theta(-2 \sec \theta)}{-\tan^2 \theta} = \frac{-2 \tan \theta \cdot \sec \theta}{-\tan^2 \theta}$$

$$= \frac{2 \sec \theta}{\tan \theta} = \frac{2 \times \cos \theta}{\sin \theta \cdot \cos \theta} = \frac{2}{\sin \theta}$$

60. (B)

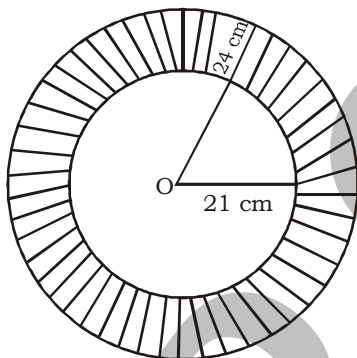

Area of circular track = Area of bigger circle - Area of smaller circle

$$= \pi R^2 - \pi r^2 \quad (\because R = 24 \text{ cm and } r = 21 \text{ cm})$$

$$= \pi(R^2 - r^2) = \frac{22}{7}(24^2 - 21^2) = \left(\frac{22}{7} \times 45 \times 3\right) \text{ cm}^2$$

$$\therefore \text{Cost of levelling} = \frac{22}{7} \times 45 \times 3 \times 10.5 = ₹ 4455$$

61. (C) $\frac{ax - by}{(a + b)(x - y)} + \frac{by - cz}{(b + c)(y - z)} + \frac{cz - ax}{(c + a)(z - x)}$

Let $\frac{x}{a} = \frac{y}{b} = \frac{z}{c} = k$ (say)

$$x = ak, y = bk \text{ and } z = ck$$

$$= \frac{a(ak) - b(bk)}{(a+b)(ak-bk)} + \frac{b(bk) - c(ck)}{(b+c)(bk-ck)} + \frac{c(ck) - a(ak)}{(c+a)(ck-ak)}$$

$$= \frac{a^2k - b^2k}{(a+b)(ak-bk)} + \frac{b^2k - c^2k}{(b+c)(bk-ck)} + \frac{c^2k - a^2k}{(c+a)(ck-ak)}$$

$$= \frac{k(a^2 - b^2)}{k(a+b)(a-b)} + \frac{k(b^2 - c^2)}{k(b+c)(b-c)} + \frac{k(c^2 - a^2)}{k(c+a)(c-a)}$$

$$= \frac{(a+b)(a-b)}{(a+b)(a-b)} + \frac{(b+c)(b-c)}{(b+c)(b-c)} + \frac{(c+a)(c-a)}{(c+a)(c-a)}$$

$$= 1 + 1 + 1 = 3$$

62. (A) Let the maximum marks be x.

ATQ,

$$x \times \frac{27}{100} + 26 = x \times \frac{42}{100} - 49$$

$$\frac{27x}{100} + 26 = \frac{42x}{100} - 49$$

$$\frac{42x}{100} - \frac{27x}{100} = 49 + 26$$

$$\frac{15x}{100} = 75$$

$$x = \frac{75 \times 100}{15} = 500$$

$$\therefore \text{Required minimum marks to pass} = 500 \times \frac{27}{100} + 26 = 161$$

63. (B) Let the distance be D km.

Speed of first trip = 80 km/hr

Time for first trip = $\frac{D}{80}$ hours

Speed of second trip = 40 km/hr

Time for second trip = $\frac{D}{40}$ hours

Speed of third trip = 20 km/hr

Time for third trip = $\frac{D}{20}$ hours

Speed of fourth trip = 10 km/hr

Time for fourth trip = $\frac{D}{10}$ hours

$$\therefore \text{Average speed} = \frac{\text{Total distance}}{\text{Total time}} = \frac{D + D + D + D}{\frac{D}{80} + \frac{D}{40} + \frac{D}{20} + \frac{D}{10}}$$

$$= \frac{4D}{\frac{D + 2D + 4D + 8D}{80}} = \frac{4D}{\frac{15D}{80}} = \frac{4D \times 80}{15D} = 21\frac{1}{3} \text{ km/hr}$$

64. (B) A completes the work in 12 days.
A and B completes the work together in 8 days.
Let the total work = 24

$$\text{A completes the work in 1 days} = \frac{24}{12} = 2$$

$$\text{A and B complete the work in 1 day} = \frac{24}{8} = 3$$

$$\text{B completes the work in 1 days} = 3 - 2 = 1$$

$$\text{Ratio of efficiency of A and B} = 2 : 1$$

$$\therefore \text{Share of B} = \frac{5190}{3} \times 1 = ₹ 1730$$

65. (C) Let the length of the rectangular field be l and breadth be b .

$$\text{Area of the rectangular field} = lb$$

Since length of a rectangular field is increased by 14 m and breadth is decreased by 6 m, still area remains the same

$$\text{Now, } lb = (l + 14)(b - 6)$$

$$14b - 6l = 84 \quad \dots\dots(i)$$

Again the length is decreased by 14 m and breadth is increased by 10 m, then also area remains the same

$$\text{Now, } lb = (l - 14)(b + 10)$$

$$10l - 14b = 140 \quad \dots\dots(ii)$$

Adding equation (i) and (ii),

$$\text{We get, } 4l = 224$$

$$l = 56 \text{ m}$$

Putting the value of l in equation (i),

$$14b - 6 \times 56 = 84$$

$$14b = 84 + 336$$

$$\therefore b = \frac{420}{14} = 30 \text{ m}$$

66. (D) Amount of milk in vessel A = $16 \times \frac{3}{4} = 12$ litres

$$\text{Amount of milk in vessel B} = 25 \times \frac{80}{100} = 20 \text{ litres}$$

$$\text{Total amount of milk in vessel C} = 12 + 20 = 32 \text{ litres}$$

$$\therefore \text{Concentration of milk in vessel C} = \left(\frac{32}{50} \times 100\right)\% = 64\%$$

67. (A) Ratio of profit of Ram and Rahim = 25000 : 35000 = 5 : 7

ATQ,

75% of profit is divided equally.

So, the difference between 25% of their profit is ₹ 130.

ATQ,

$$7 \times \frac{25}{100} - 5 \times \frac{25}{100} \rightarrow ₹130$$

$$\frac{7}{4} - \frac{5}{4} \rightarrow ₹130$$

$$\frac{1}{2} \rightarrow ₹130$$

$$1 \rightarrow ₹260$$

$$\therefore \text{Total profit} = (7 + 5) \times 260 = ₹ 3120$$

68. (C) $\frac{6x}{3x^2 + 4x + 1} = \frac{1}{4}$

$$3x^2 + 4x + 1 = 24x$$

$$3x^2 + 1 = 20x$$

Now,

$$x + \frac{1}{3x} = \frac{3x^2 + 1}{3x} = \frac{20x}{3x} \quad (\because 3x^2 + 1 = 20x)$$

$$= \frac{20}{3}$$

69. (B)

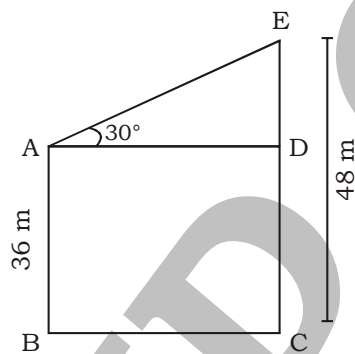

Let AB and CE are two poles of height 36 m and 48 m respectively and AE is the length of wire.

$$DE = CE - AB = 48 - 36 = 12 \text{ m}$$

In $\triangle ADE$,

$$\sin 30^\circ = \frac{DE}{AE}$$

$$\frac{1}{2} = \frac{12}{AE}$$

$$AE = 12 \times 2 = 24 \text{ m}$$

$$\therefore \text{Length of wire} = 24 \text{ m}$$

70. (A) Let the first term is a_1 and the common difference is d .

$$a_3 = a_1 + 2d = -15 \quad \dots(i)$$

$$a_6 = a_1 + 5d = -6 \quad \dots(ii)$$

Subtracting equation (i) from (ii),

$$a_1 + 2d - a_1 - 5d = -15 - (-6)$$

$$-3d = -9$$

$$d = 3$$

Put the value of d in equation (i),

$$a_1 + 2d = -15$$

$$a_1 + 2 \times 3 = -15$$

$$a_1 = -15 - 6 = -21$$

$$\therefore S_n = \frac{n}{2}[2a_1 + (n-1)d]$$

$$S_{16} = \frac{16}{2}[2 \times -21 + (16-1) \times 3]$$

$$= 8 \times [-42 + 45]$$

$$= 8 \times 3 = 24$$

71. (A) Profit percentage of company A in the year 2017 = $\left(\frac{7.5-6}{6} \times 100\right)\% = 25\%$

$$\text{Profit percentage of Company C in the year 2013} = 25 \times \frac{125}{100} = 31.25\%$$

$$\therefore \text{The Expenditure of company C in the year 2013} = \left(\frac{4.5}{131.25} \times 100\right) \approx ₹ 3.42 \text{ lakh}$$

72. (B) Profit of company A in the year 2013 = $\left[\frac{(5-2.50)}{2.50} \times 100\right]\% = 100\%$

$$\text{The expenditure of company B in the year 2015} = 2.50 \times \frac{100}{125} = ₹ 2 \text{ lakh}$$

$$\text{Profit of company B in the year 2015} = \left[\frac{(7-2)}{2} \times 100\right]\% = 250\%$$

$$\therefore \text{Required ratio} = 100 : 250 = 2 : 5$$

73. (C) $\frac{\text{Income of company B in the year 2016}}{\text{Expenditure of company B in the year 2016}} = \frac{5}{4}$

$$\frac{6.5}{\text{Expenditure of company B in 2016}} = \frac{5}{4}$$

$$\text{Expenditure of company B in the year 2016} = 6.5 \times \frac{4}{5} = ₹ 5.2 \text{ lakh}$$

$$\text{Expenditure of C in the year 2012} = 5.2 \times 0.5 = ₹ 2.6 \text{ lakh}$$

$$\therefore \text{Profit of company C in the year 2012} = \left[\frac{(6-2.6)}{2.6} \times 100\right]\% = 130.76\% \approx 131\%$$

74. (A) Expenditure of company B in the year 2013 = $\left(\frac{6}{120} \times 100\right) = ₹ 5 \text{ lakh}$

Expenditure of company A in the year 2018 = Expenditure of company B in the year 2013
= ₹ 5 lakh

Income of company A in the year 2018 = $5 \times \frac{160}{100} = ₹ 8 \text{ lakh}$

∴ Profit of company A in the year 2018 = $\left(\frac{8-5}{5} \times 100\right)\% = 60\%$

75. (D) Required percentage increase in the income of company A = $\left[\frac{(5.5-4)}{4} \times 100\right]\% = 37.5\%$

MEANINGS IN ALPHABETICAL ORDER

Absurdity	the quality or state of being ridiculous or wildly unreasonable	मूर्खता
Antipathy	a deep-seated feeling of dislike; aversion	घृणा
Apathy	lack of interest, enthusiasm, or concern	उदासीनता
Aversion	a strong dislike or disinclination	घृणा
Blaze	a very large or fiercely burning fire	ज्वाला
Brawl	a rough or noisy fight or quarrel	विवाद
Conjure	call upon (a spirit or ghost) to appear, by means of a magic ritual	जादू
Deception	the action of deceiving someone	धोखा
Despair	the complete loss or absence of hope	निराशा
Faint	(of a sight, smell, or sound) barely perceptible	बेहोश
Feeble	lacking physical strength, especially as a result of age or illness	कमजोर
Fitfully	not regularly or continuously; intermittently	उपयुक्त रूप से
Forbid	not allowed; banned	वर्जित
Loathing	a feeling of intense dislike or disgust; hatred	घृणा
Rage	violent, uncontrollable anger	क्रोध
Relevance	the quality or state of being closely connected or appropriate	प्रासंगिकता
Slander	the action or crime of making a false spoken statement damaging to a person's reputation	बदनामी
Staunch	loyal and committed in attitude	निष्ठावान
Steadfast	resolutely or dutifully firm and unwavering	दृढ़
Summon	authoritatively or urgently call on (someone) to be present, especially as a defendant or witness in a law court	गवाही के लिए बुलावा भेजना
Superficial	existing or occurring at or on the surface	सतही
Tangential	relating to or along a tangent	स्पर्शरेखा
Wavering	moving in a quivering way; flickering	दुलमुल

SSC MOCK TEST - 296 (ANSWER KEY)

- | | | | |
|---------|---------|---------|----------|
| 1. (B) | 26. (A) | 51. (B) | 76. (C) |
| 2. (B) | 27. (A) | 52. (C) | 77. (C) |
| 3. (D) | 28. (A) | 53. (D) | 78. (A) |
| 4. (D) | 29. (B) | 54. (C) | 79. (A) |
| 5. (C) | 30. (A) | 55. (B) | 80. (C) |
| 6. (C) | 31. (A) | 56. (D) | 81. (C) |
| 7. (B) | 32. (D) | 57. (C) | 82. (B) |
| 8. (B) | 33. (B) | 58. (B) | 83. (D) |
| 9. (C) | 34. (A) | 59. (A) | 84. (D) |
| 10. (B) | 35. (C) | 60. (B) | 85. (C) |
| 11. (B) | 36. (B) | 61. (C) | 86. (C) |
| 12. (C) | 37. (B) | 62. (A) | 87. (B) |
| 13. (B) | 38. (B) | 63. (B) | 88. (D) |
| 14. (C) | 39. (D) | 64. (B) | 89. (B) |
| 15. (B) | 40. (A) | 65. (C) | 90. (A) |
| 16. (B) | 41. (B) | 66. (D) | 91. (C) |
| 17. (C) | 42. (A) | 67. (A) | 92. (D) |
| 18. (B) | 43. (A) | 68. (C) | 93. (C) |
| 19. (C) | 44. (C) | 69. (B) | 94. (D) |
| 20. (B) | 45. (A) | 70. (A) | 95. (A) |
| 21. (D) | 46. (B) | 71. (A) | 96. (C) |
| 22. (C) | 47. (C) | 72. (B) | 97. (B) |
| 23. (D) | 48. (B) | 73. (C) | 98. (C) |
| 24. (A) | 49. (D) | 74. (A) | 99. (A) |
| 25. (C) | 50. (C) | 75. (D) | 100. (C) |

76. (C) Replace "for drive" with "for driving/to drive". Generally preposition should be followed by V₄ form and when 'to' is the part of infinitive, it should be followed by the base form of the main verb.
77. (C) Use definite article 'the' before the name of ocean (the Atlantic Ocean)
90. (A) The correct spelling of 'Foreiner' is 'Foreigner'.
91. (C) The correct spelling of 'Florish' is 'Flourish'.