

**SSC MOCK TEST - 338 (SOLUTION)**

1. (B) Arc is a part of Circle, while Petal is a part of Flower.

2. (B) As,  $(432 \div 3) + 3 = 147$   
Similarly,  $(963 \div 3) + 3 = 324$

3. (B) Except 734, sum of others are prime number.

4. (C) Except Monitor, others are input device.

5. (D) As, And,

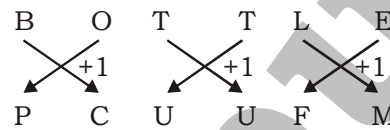
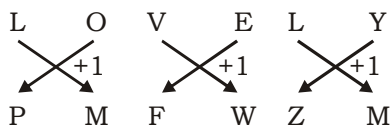

Similarly,

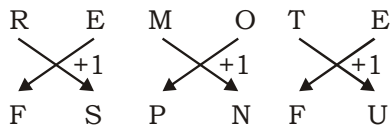

6. (B) 128 139 172 227 304 403  
 $\begin{matrix} \uparrow & \uparrow & \uparrow & \uparrow & \uparrow \\ +11 & +33 & +55 & +77 & +99 \end{matrix}$   
 $\begin{matrix} \uparrow & \uparrow & \uparrow & \uparrow \\ +22 & +22 & +22 & +22 \end{matrix}$

7. (C) Z A C Z D Y  
 $\begin{matrix} \curvearrowright & \curvearrowright & \curvearrowright & \curvearrowright & \curvearrowright \\ -1 & +2 & -3 & +4 & -5 \end{matrix}$

8. (B)  $\begin{matrix} \rightarrow \text{C} \\ \rightarrow \text{P} \\ \rightarrow \text{R} \\ \rightarrow \text{S} \\ \rightarrow \text{O} \\ \rightarrow \text{S} \end{matrix}$

Hence, S is at the right end.

9. (C) As,  $24 \times (2 + 4) - 117 = 27$   
Similarly,  $35 \times (3 + 5) - 217 = 63$

10. (B) djrc/djrc/djrc

11. (C) **In the first column,**  
 $(9)^2 - 27 = 54$

**In the second column,**  
 $(12)^2 - 12 = 132$

**In the third column,**  
 $(13)^2 - 18 = 151$

12. (D)

13. (A)  $288 \div 4 \times 12 + 24 - 40 + 13 = 121$

After changing 4 and 24,

$$288 \div 24 \times 12 + 4 - 40 + 13 = 121$$

$$12 \times 12 + 4 - 40 + 13 = 121$$

$$148 + 13 - 40 = 121$$

$$161 - 40 = 121$$

$$121 = 121$$

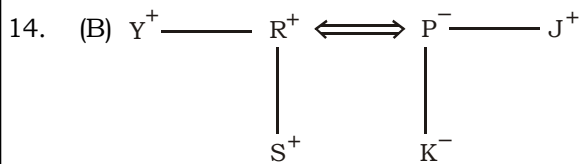

Hence, P have two children.

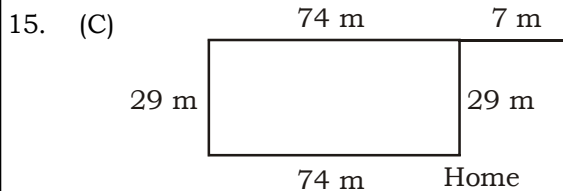

Hence, she is 7 m away from pole.

16. (B) 5. Study  $\rightarrow$  2. Examination  $\rightarrow$  3. Evaluation  $\rightarrow$  1. Result  $\rightarrow$  4. Re-evaluation

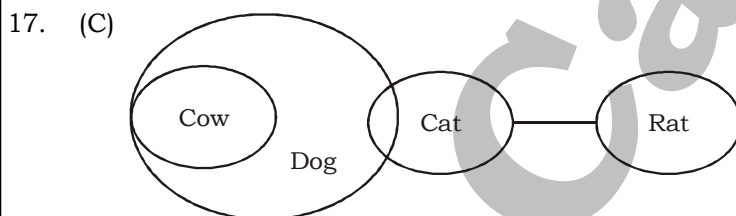

I. Doubt    II. Doubt    III. False

Hence, Either conclusion I or II follows.

18. (D)    19. (C)

20. (A) As,  $(17 + 42) \times 4 = 236$

Similarly,  $(22 + 36) \times 4 = 232$

21. (B) As,

L E S S O N

$$12 + 5 + 19 + 19 + 15 + 14 = 84 \Rightarrow 84 \times 6 \text{ (Number of letters)} = 504$$

And,

M O S T

$$13 + 15 + 19 + 20 = 67 \Rightarrow 67 \times 4 \text{ (Number of letters)} = 268$$

Similarly,

S U N D A Y

$$19 + 21 + 14 + 4 + 1 + 25 = 84 \Rightarrow 84 \times 6 \text{ (Number of letters)} = 504$$

22. (B)    23. (D)    24. (B)    25. (A)

26. (C) In 1018, Rajendra conquered Ceylon (Sri Lanka). Earlier Rajaraja I conquered only half of it.
27. (A) The Nile River begins at the equator and ends at the Mediterranean Sea. It flows through Egypt, Sudan, Uganda, Ethiopia, Zaire, the Sahara Desert, Kenya, Tanzania, Eritrea, Burundi and Rwanda. The Nile River is the longest river in the world. It is often associated with Egypt. It has two tributaries. The White Nile starts at Lake Victoria, and the Blue Nile starts at Lake Tana. The two tributaries merge in Sudan.
29. (B) In 1881 the first entirely Indian joint stock bank was the Oudh Commercial Bank, established in Faizabad. It collapsed in 1958. The next i.e the Punjab National Bank was established in Lahore in 1895, which has survived to the present and is now one of the largest bank in India.
30. (A) Stars twinkle because they are point light sources. Passing through the atmosphere, the small beam of light constantly shifts by bouncing off particles in the air. Planets are closer, so they appear as discs, with the shifting of light from one side cancelling out the other. The atmosphere of the Earth is a turbulent medium, with streams and columns of air churning around and dispersing all the time. These disturbances act like lenses and prisms that shift the light from side to side by small amounts several times a second. Since they are so far away and the beam of light is so thin, the stars appear to twinkle.
31. (C) There are 118 known elements on the periodic table. The most recently discovered element, Ununoctium, was first reported by Russian scientists from Dubna in 2002. Russian scientist Dmitri Mendeleev is usually credited with the first known publication of a periodic table of elements, in 1869. He created the table by arranging known elements into rows and columns based on atomic weight and the similarity between elements. Using this method, he was also able to predict the existence of unknown elements, such as Gallium and Germanium. The standard periodic table style in use today is attributed to Horace Deming, an American scientist.
32. (A) Ergotism is the effect of long term ergot poisoning, due to ingestion of alkaloids produced by fungus *Claviceps purpurea* which is found in infected cereals and ryes.
33. (B) PROLOG is a general purpose logic programming language associated with artificial intelligence and computational linguistics.
34. (B) The Sessa Orchid Sanctuary is located in the Himalayan foothills in Bhalukpong Forest Division of West Kameng District, Arunachal Pradesh. It conjoins Eaglenest Wildlife Sanctuary to the southwest. It is a part of the Kameng Protected Area Complex (KPAC), which is an Elephant Reserve. The sanctuary is unique in having 7 endemic species of saprotrophic orchids.
35. (C) The Maharashtra government has developed a website-based migration tracking system (MTS) application to map the movement of vulnerable seasonal migrant workers.
36. (B) States such as Champa (Chamba), Durgara (Jammu), Trigarta (Jalandhar), Kuluta (Kulu), Kumaon and Garhwal managed to remain outside the main areas of conflict in the northern plains.
37. (C) Diamantine Trench is situated in southeast part of Indian Ocean. The depth of Diamantine Trench is 8047 m. Name Deepest point (km) 1 Mariana Trench 11.0 km Pacific Ocean (near Japan) 2 Philippine Trench 10.4 km Pacific Ocean the 3 Bonin Trench 9.99 km Pacific Ocean (near Japan) 4 New Britain Trench 9.94 km Pacific Ocean (near New Guinea) 5 Kuril Trench 9.75 km Pacific Ocean (near Russia) Ocean (near Philippine islands)
40. (D) It is just because woolen clothes have fibres and between those fibres air is trapped which reduces heat loss. Air reduces heat loss because it is an insulator i.e. poor conductor of heat. Hence, all the heat from our body gets trapped inside the clothes which makes us feels warmer with the clothes.
41. (A) Friedrich Wohler is widely considered the father of organic chemistry. He was a German chemist who lived in the 1800s and is well-known for synthesizing urea in 1828. Brass is a bright gold metal that is more malleable than zinc or bronze. It is often used in musical instruments because of its acoustic properties.

42. (D) Saffron is a spice derived from the flower of *Crocus sativus*, commonly known as the "saffron crocus". Saffron is a spice obtained from the stigma of the flower of *Crocus sativus* Linnalus.
43. (C) The National Safety Council (NSC) is a self-supporting non-profit autonomous society, set up by the Ministry of Labour and Employment, Govt. of India (GoI) on 4th March 1966. Its aim is to strengthen a national movement on Safety, Health & Environment (SHE) to prevent and mitigate loss of life, human suffering & economic losses and provide support services. It is in news because the 2016 NSCI Safety Awards will be presented by the Minister of State (Independent Charge), Labour & Employment Bandaru Dattatreya on April 20, 2017 in New Delhi. The NSCI Safety Awards are coveted national level awards in the field of Workplace Safety, Health and Environment. The headquarters of the NSC is located in Mumbai, Maharashtra.
44. (C) Cabinet mission proposed a rejection of the demand for a full-fledged Pakistan because the Pakistan so formed would include large Non-Muslim population - 38% in the N-W and 48% in the N-E.
45. (D) Venus can be seen with the unaided eye from Earth. It is the brightest planet in our Solar System. Venus was given the nickname evening star and morning star because of its bright consistent presence.
50. (B) The Civil Services Day (CSD) is organized every year on April 21 in India by civil servants to rededicate and recommit themselves to the cause of the people. This day gives civil servants the opportunity for introspection and thinking about future strategies to deal with the challenges being posed by the changing times. On this occasion, all officers of Central and State Governments are honoured for excellence in public administration by the Prime Minister of India. The Prime Minister Narendra Modi will confer PM's awards for Excellence in Public Administration to Districts/Implementing units and other Central/State organisations on April 21, 2017 for effective implementation of Identified Priority Programmes and Innovation.

51. (A) Let A's salary be ₹ x.  
B's salary = ₹ (54000 - x)  
Saving of A = 5% of x

$$\text{Saving of B} = ₹ (54000 - x) \times \frac{20}{100}$$

ATQ,

$$\frac{5}{100} \times x = (54000 - x) \times \frac{20}{100}$$

$$x = 54000 \times 4 - 4x$$

$$5x = 54000 \times 4$$

$$x = \frac{54000 \times 4}{5} = ₹ 43200$$

52. (C) Let the denominator be x.

$$\text{Numerator} = x + 4$$

ATQ,

$$\frac{x + 4 + 6}{x - 3} = \frac{19}{6}$$

$$6x + 60 = 19x - 57$$

$$13x = 117$$

$$x = \frac{117}{13} = 9$$

$$\text{Fraction} = \frac{9+4}{9} = \frac{13}{9}$$

$$\therefore \text{Required fraction} = \frac{13}{9} \div \frac{4}{3} = \frac{13}{9} \times \frac{3}{4} = \frac{13}{12}$$

53. (D)  $\left( \frac{\sec \theta}{\cot \theta + \tan \theta} \right)^2 = \left( \frac{\frac{1}{\cos \theta}}{\frac{\cos \theta}{\sin \theta} + \frac{\sin \theta}{\cos \theta}} \right)^2$

$$= \left( \frac{\frac{1}{\cos \theta}}{\frac{\sin^2 \theta + \cos^2 \theta}{\sin \theta \cdot \cos \theta}} \right)^2 = \left( \frac{\frac{1}{\cos \theta}}{\frac{1}{\sin \theta \cdot \cos \theta}} \right)^2$$

$$= (\sin \theta)^2 = \sin^2 \theta$$

54. (C) Surface area of cube =  $6 \times (s)^2$

Surface area of sphere =  $4\pi r^2$

ATQ,

$$6s^2 = 4\pi r^2$$

$$\frac{s^2}{r^2} = \frac{4\pi}{6}$$

$$\frac{s}{r} = \frac{2\sqrt{\pi}}{\sqrt{6}}$$

$$\therefore \frac{\text{Volume of cube}}{\text{Volume of sphere}} = \frac{s^3}{\frac{4}{3}\pi r^3}$$

$$= \frac{(2\sqrt{\pi})^3}{\frac{4}{3}\pi \times (\sqrt{6})^3} = \frac{8\pi \times \sqrt{\pi} \times 3}{4\pi \times 6 \times \sqrt{6}} = \sqrt{\pi} : \sqrt{6}$$

55. (C) (A + B)'s 1 day work =  $\frac{1}{24}$  ....(i)

(B + C)'s 1 day work =  $\frac{1}{16}$  ....(ii)

(C + A)'s 1 day work =  $\frac{1}{12}$  ....(iii)

On adding equation (i), (ii) and (iii),

$$2(A + B + C)'s 1 \text{ day work} = \frac{1}{24} + \frac{1}{16} + \frac{1}{12}$$

$$= \frac{2+3+4}{48} = \frac{9}{48}$$

$$(A + B + C)'s \text{ 1 day work} = \frac{9}{96} \quad \dots(iv)$$

On subtracting equation (iii) from equation (iv), we get

$$B's \text{ 1 day work} = \frac{9}{96} - \frac{1}{12} = \frac{9-8}{96} = \frac{1}{96}$$

∴ B can complete the work in 96 days.

56. (C)  $2\cos^2 A = 3\sin A$

$$2(1 - \sin^2 A) = 3\sin A$$

$$2 - 2\sin^2 A = 3\sin A$$

$$2\sin^2 A + 3\sin A - 2 = 0$$

$$2\sin^2 A + 4\sin A - \sin A - 2 = 0$$

$$2\sin A (\sin A + 2) - 1(\sin A + 2) = 0$$

$$(2\sin A - 1) (\sin A + 2) = 0$$

$$\sin A = \frac{1}{2}$$

$$\sin A = \sin 30^\circ$$

$$A = 30^\circ$$

$$\therefore \operatorname{cosec}^2 A - \cot^2 A + \cos^2 A = \operatorname{cosec}^2 30^\circ - \cot^2 30^\circ + \cos^2 30^\circ$$

$$= (2)^2 - (\sqrt{3})^2 + \left(\frac{\sqrt{3}}{2}\right)^2 = 4 - 3 + \frac{3}{4} = 1 + \frac{3}{4} = \frac{7}{4}$$

57. (B)  $x + \frac{1}{x} = \sqrt{20}$

Squaring both sides,

$$x^2 + \frac{1}{x^2} + 2 = 20$$

$$x^2 + \frac{1}{x^2} = 18 \quad \dots(i)$$

Also,

$$\left(x - \frac{1}{x}\right)^2 = x^2 + \frac{1}{x^2} - 2$$

$$\left(x - \frac{1}{x}\right)^2 = 18 - 2$$

$$x - \frac{1}{x} = 4 \quad \dots(ii)$$

Cubing both sides,

$$x^3 - \frac{1}{x^3} - 3 \times x \times \frac{1}{x} \left(x - \frac{1}{x}\right) = 64$$

$$x^3 - \frac{1}{x^3} - 3 \times 4 = 64$$

$$x^3 - \frac{1}{x^3} = 64 + 12 = 76 \quad \dots\text{(iii)}$$

Now,

$$\left(x^2 + \frac{1}{x^2}\right)\left(x^3 - \frac{1}{x^3}\right) = \left(x^5 - \frac{1}{x^5}\right) + \left(x - \frac{1}{x}\right)$$

$$\therefore x^5 - \frac{1}{x^5} = 18 \times 76 - 4 = 1364$$

58. (D)

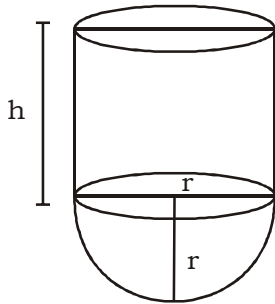

Diameter of hemisphere = 16 cm

Radius = 8 cm

Ratio of height of cylinder : Radius of hemisphere = 2 : 1

Height of cylinder = 2 × 8 = 16 cm

Total volume of vessel = Volume of cylinder + Volume of hemisphere =  $\pi r^2 h + \frac{2}{3} \pi r^3$

$$= \pi \times 8 \times 8 \times 16 + \frac{2}{3} \pi \times 8 \times 8 \times 8 = 1024 \pi + \frac{1024}{3} \pi$$

$$= \frac{4096}{3} \pi = 1365 \frac{1}{3} \pi \text{ cm}^3$$

59. (A) Let the length of tunnel = x m

$$\text{Speed of train} = 72 \times \frac{5}{18} = 20 \text{ m/s}$$

ATQ,

$$\frac{600 + x}{20} = 60$$

$$600 + x = 1200$$

$$\therefore x = 1200 - 600 = 600 \text{ m}$$

60. (C)

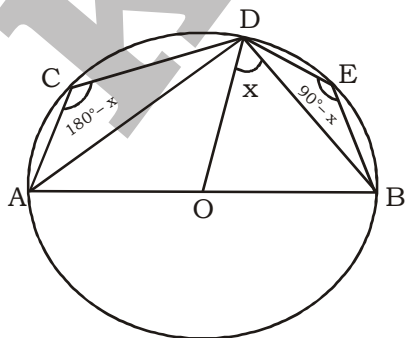

Since,  $\angle ADB$  lies on circumference, so  $\angle ADB = 90^\circ$

Consider quadrilateral ABDC, it is a cyclic quadrilateral.

So, if  $\angle ADB = 90^\circ$

Let  $\angle ODB = x$

$\angle ADO = 90^\circ - x$

Now, since  $AO = OD = OB$

$\angle ODB = \angle DBO = x$

And, if  $\angle ADO = 90^\circ - x$

Then  $\angle DAO = 90^\circ - x$

ADEB is cyclic quadrilateral.

So, if  $\angle A = 90^\circ - x$ , then  $\angle E = 90^\circ + x$  (as  $\angle A + \angle E = 180^\circ$ )

Similarly, ACDB is cyclic quadrilateral.

$\angle B + \angle C = 180^\circ$

$x + \angle C = 180^\circ$

$\angle C = 180^\circ - x$

Hence,  $\angle C = 180^\circ - x$  and  $\angle E = 90^\circ + x$

$\angle C + \angle E = (180^\circ - x) + (90^\circ + x) = 270^\circ$

61. (A) Let the LCM be  $5x$ .

HCF =  $x$

ATQ,

$5x \times x = 1125$

$5x^2 = 1125$

$x^2 = 225$

$x = 15$

$\therefore$  HCF = 15

62. (B)  $\frac{x+y}{x-y} = \frac{13}{4}$

$4x + 4y = 13x - 13y$

$13x - 4x = 4y + 13y$

$9x = 17y$

$\frac{x}{y} = \frac{17}{9}$

$\therefore \frac{(5x+3y)}{(x-2y)} = \frac{5 \times 17 + 3 \times 9}{17 - 2 \times 9} = \frac{85 + 27}{-1} = -112$

63. (D)

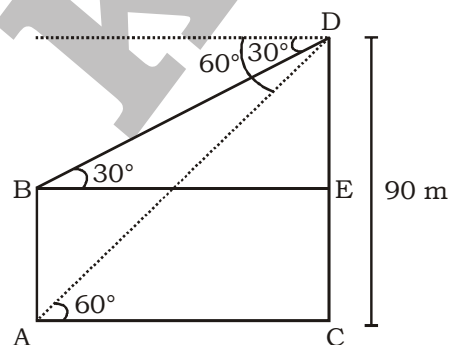



Let AB and CD be heights of tower and building respectively.

In  $\triangle ACD$ ,

$$\tan 60^\circ = \frac{CD}{AC}$$

$$\sqrt{3} = \frac{90}{AC}$$

$$AC = \frac{90}{\sqrt{3}} \text{ m}$$

$$AC = BE = \frac{90}{\sqrt{3}} \text{ m}$$

Let height of tower be x m.

$$AB = CE = x \text{ m}$$

In  $\triangle BED$ ,

$$\tan 30^\circ = \frac{DE}{BE}$$

$$\frac{1}{\sqrt{3}} = \frac{90 - x}{\frac{90}{\sqrt{3}}}$$

$$\frac{1}{\sqrt{3}} = \frac{(90 - x)\sqrt{3}}{90}$$

$$270 - 3x = 90$$

$$3x = 270 - 90$$

$$x = \frac{180}{3} = 60 \text{ m}$$

$\therefore$  Height of tower = 60 m

64. (A)  $p^{1/3} + q^{1/3} - r^{1/3} = 0$

$$p^{1/3} + q^{1/3} = r^{1/3}$$

Cubing both sides, we get

$$p + q + 3p^{1/3}q^{1/3}\left(p^{1/3} + q^{1/3}\right) = r$$

$$p + q - r = -3p^{1/3}q^{1/3}\left(p^{1/3} + q^{1/3}\right)$$

$$p + q - r = -3p^{1/3}q^{1/3}r^{1/3}$$

Again cubing both sides, we get

$$(p + q - r)^3 = -27 pqr$$

$\therefore (p + q - r)^3 + 27 pqr = 0$

65. (C) Let the capital invested be ₹ x.

$$\frac{1}{3} \text{ of capital} = ₹ \frac{x}{3}$$

$$\frac{1}{4} \text{ of capital} = ₹ \frac{x}{4}$$

$$\text{Remaining capital} = x - \left( \frac{x}{3} + \frac{x}{4} \right) = x - \left( \frac{4x + 3x}{12} \right) = ₹ \frac{5x}{12}$$

ATQ,

$$\frac{\frac{x}{3} \times 6}{100} + \frac{\frac{x}{4} \times 9}{100} + \frac{\frac{5x}{12} \times 10}{100} = 1212$$

$$\frac{2x}{100} + \frac{9x}{400} + \frac{25x}{600} = 1212$$

$$\frac{24x + 27x + 50x}{1200} = 1212$$

$$\frac{101x}{1200} = 1212$$

$$\therefore x = \frac{1212 \times 100}{101} = ₹ 1200$$

66. (A)  $4a3 + 984 = 13b7$

$13b7$  will be divisible by 11, if  $b = 9$

$$1397 = 11 \times 127$$

Hence  $4a3 + 984 = 1397$

$$4a3 = 413$$

Hence  $a = 1$

$$\therefore (a + b) = 1 + 9 = 10$$

67. (B)

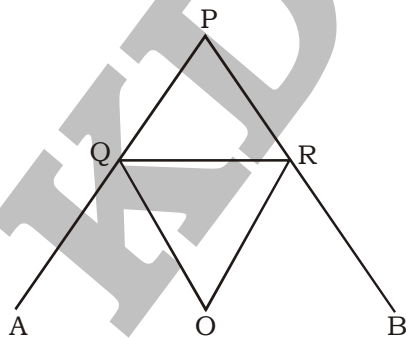

Let  $\angle AQP = \angle OQR = x^\circ$

And  $\angle BRO = \angle ORQ = y^\circ$

Given that,  $\angle ROQ = 60^\circ$

In  $\Delta OQR$ ,

$$\angle OQR + \angle QRO + \angle ROQ = 180^\circ$$

$$x + y + 60^\circ = 180^\circ$$

$$x + y = 120^\circ$$

In  $\Delta PQR$ ,

$$\angle QPR + \angle PQR + \angle PRQ = 180^\circ$$

$$\angle QPR + 180^\circ - 2x + 180^\circ - 2y = 180^\circ$$

$$\angle QPR + 180^\circ - 2 \times 120^\circ = 0$$

$$\therefore \angle QPR = 60^\circ$$

68. (A) 
$$\left( \frac{\sin \theta - 2\sin^3 \theta}{2\cos^3 \theta - \cos \theta} \right) + 1 = \frac{\sin^2 \theta (1 - 2\sin^2 \theta)^2}{\cos^2 \theta (2\cos^2 \theta - 1)^2} + 1$$

$$= \frac{\tan^2 \theta (\cos 2\theta)^2}{(\cos 2\theta)^2} + 1 = \tan^2 \theta + 1 = \sec^2 \theta$$

69. (C) By Alligation method,

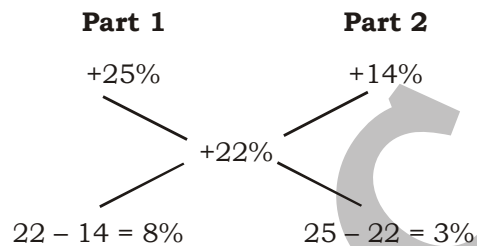

Ratio = 8 : 3

$$\therefore \text{Quantity of wheat sold at 25\% profit} = \frac{2200}{11} \times 8 = 1600 \text{ kg}$$

70. (A)  $2A = 3B$

$$\frac{A}{B} = \frac{3}{2}$$

$$A : B = 3 : 2 \quad \dots(i)$$

$$B = 4C$$

$$\frac{B}{C} = \frac{4}{1}$$

$$B : C = 4 : 1 \quad \dots(ii)$$

$$A : B : C = 6 : 4 : 1 \quad \dots(iii)$$

$$\therefore \text{Share of C} = \frac{253000}{11} \times 1 = ₹ 23000$$

71. (D) Expenditure of company P in the year 2001 =  $\frac{510}{120} \times 100 = ₹ 425$  lakh  
 $\therefore$  Required less% =  $\left(\frac{490 - 425}{490} \times 100\right)\% = 13.26\% \approx 13\%$  less
72. (A) Expenditure of company Q in the year 2004 =  $490 - 10 = ₹ 480$  lakh  
 $\therefore$  Required profit% =  $\left(\frac{590 - 480}{480} \times 100\right)\% = 22.91\% \approx 23\%$
73. (A) Total incomes of company P and Q together in the year 2003 =  $370 \times \frac{116}{100} + 380 \times \frac{117}{100}$   
 $= 429.20 + 444.60 = ₹ 873.80$  lakh  
 $\therefore$  Required average =  $\frac{873.80}{2} = ₹ 436.9$  lakh
74. (D) Expenditure of company P in the year 2005 =  $515 - 30 = ₹ 485$  lakh  
 $\therefore$  Required % =  $\left(\frac{485}{515} \times 100\right)\% = 94.17\% \approx 94\%$
75. (B) Profit of company P in the year 2004 =  $580 - 490 = ₹ 90$  lakh  
 $\therefore$  Required % =  $\left(\frac{550 - 90}{90} \times 100\right)\% = 511.11\% \approx 511\%$

## MEANINGS IN ALPHABETICAL ORDER

|               |                                                                                                                       |                 |
|---------------|-----------------------------------------------------------------------------------------------------------------------|-----------------|
| Apprehension  | anxiety or fear that something bad or unpleasant will happen                                                          | आशंका           |
| Ceramic       | made of clay and hardened by heat                                                                                     | चीनी मिट्टी     |
| Clemency      | mercy; lenience                                                                                                       | दया             |
| Coincident    | occurring together in space or time                                                                                   | मुनासिब         |
| Concomitant   | naturally accompanying or associated                                                                                  | सहगामी          |
| Concurrent    | existing, happening, or done at the same time                                                                         | समवर्ती         |
| Contemporary  | living or occurring at the same time                                                                                  | समकालीन         |
| Crockery      | plates, dishes, cups, and other similar items, especially ones made of earthenware or china                           | मिट्टी के बर्तन |
| Degeneration  | the state or process of being or becoming degenerate; decline or deterioration                                        | पतन             |
| Degradation   | the condition or process of degrading or being degraded                                                               | निम्नीकरण       |
| Demotion      | reduction in rank or status                                                                                           | पदावनति         |
| Deterioration | the process of becoming progressively worse                                                                           | बिगड़ना         |
| Distressed    | suffering from anxiety, sorrow, or pain                                                                               | व्यथित          |
| Dynamics      | the branch of mechanics concerned with the motion of bodies under the action of forces                                | गतिकी           |
| Elite         | a select group that is superior in terms of ability or qualities to the rest of a group or society                    | अभिजात वर्ग     |
| Eminent       | (of a person) famous and respected within a particular sphere or profession                                           | प्रख्यात        |
| Empathy       | the ability to understand and share the feelings of another                                                           | समानुभूति       |
| Flamboyant    | (of a person or their behavior) tending to attract attention because of their exuberance, confidence, and stylishness | चमकीला          |
| Humiliation   | the action of humiliating someone or the state of being humiliated                                                    | निरादर          |
| Prominent     | important; famous                                                                                                     | प्रमुख          |

**SSC MOCK TEST - 338 (ANSWER KEY)**

- |         |         |         |          |
|---------|---------|---------|----------|
| 1. (B)  | 26. (C) | 51. (A) | 76. (B)  |
| 2. (B)  | 27. (A) | 52. (C) | 77. (A)  |
| 3. (B)  | 28. (D) | 53. (D) | 78. (A)  |
| 4. (C)  | 29. (B) | 54. (C) | 79. (D)  |
| 5. (D)  | 30. (A) | 55. (C) | 80. (B)  |
| 6. (B)  | 31. (C) | 56. (C) | 81. (B)  |
| 7. (C)  | 32. (A) | 57. (B) | 82. (A)  |
| 8. (B)  | 33. (B) | 58. (D) | 83. (D)  |
| 9. (C)  | 34. (B) | 59. (A) | 84. (A)  |
| 10. (B) | 35. (C) | 60. (C) | 85. (B)  |
| 11. (C) | 36. (B) | 61. (A) | 86. (C)  |
| 12. (D) | 37. (C) | 62. (B) | 87. (C)  |
| 13. (A) | 38. (B) | 63. (D) | 88. (B)  |
| 14. (B) | 39. (C) | 64. (A) | 89. (B)  |
| 15. (C) | 40. (D) | 65. (C) | 90. (C)  |
| 16. (B) | 41. (A) | 66. (A) | 91. (B)  |
| 17. (C) | 42. (D) | 67. (B) | 92. (A)  |
| 18. (D) | 43. (C) | 68. (A) | 93. (B)  |
| 19. (C) | 44. (C) | 69. (C) | 94. (A)  |
| 20. (A) | 45. (D) | 70. (A) | 95. (B)  |
| 21. (B) | 46. (C) | 71. (D) | 96. (A)  |
| 22. (B) | 47. (C) | 72. (A) | 97. (A)  |
| 23. (D) | 48. (B) | 73. (A) | 98. (D)  |
| 24. (B) | 49. (B) | 74. (D) | 99. (B)  |
| 25. (A) | 50. (B) | 75. (B) | 100. (A) |

76. (B) The sentence is in passive voice.

Active voice: Subject + was/were + V1+ing + object

Passive voice: Object+ was/were + being + V3 + (by + subject)

**Correct sentence:** Bags and purses were thoroughly checked at the entrance to the theatre.

77. (A) The sentence talks about a past event. Use 'parted' instead of 'part.'

**Correct sentence:** He parted the grass at the place where he had seen the deer.

86. (C) The correct answer is (3). The sentence is talking about past. Use of 'hasn't been use' is wrong.

**Correct sentence:** It was a second hand car but it hadn't been used much.

87. (C) The correct answer is (3). In this sentence the question tag is wrong. With 'have,' 'haven't they' will be right.

**Correct sentence:** The medicines have arrived, haven't they?