

SSC MOCK TEST - 416 (SOLUTION)

1. (3) As, $1627 \Rightarrow (27 - 16)^2 = 121$

Similarly, $1924 \Rightarrow (24 - 19)^2 = 25$

2. (4) Heart is related to Circulation, while Kidney is related to Excretion.

3. (1) Except Big, others are related to each other.

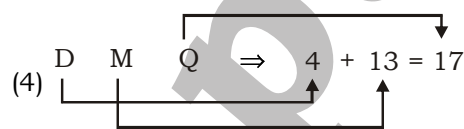
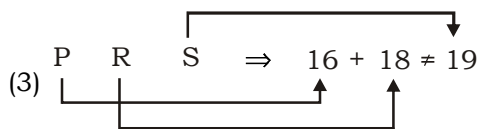
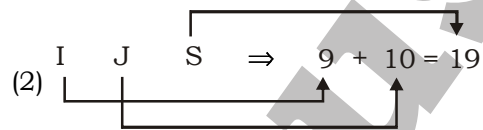
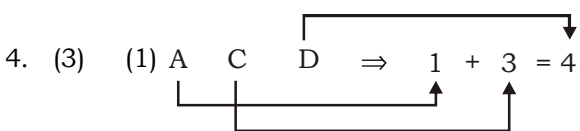

5. (2) As,

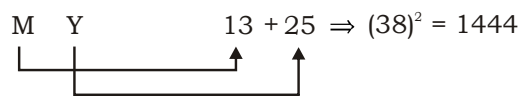

Similarly,

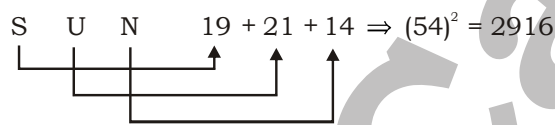

6. (3)

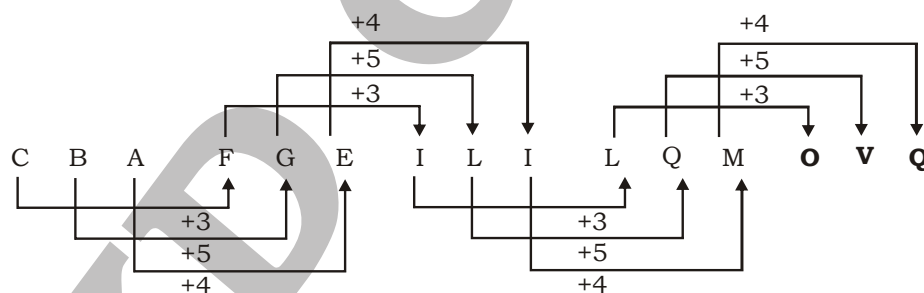

8. (1) As, 2013 was not a leap year and 1 January 2013 was Wednesday.

Then, number of days between 1 January 2013 and 2 January 2014 = 369 days

So, odd days = $\frac{369}{7} \Rightarrow 5$ days

\therefore 5 January 2014 is five days after Wednesday = Monday

9. (3) As,

$$84 + \left(\frac{84}{2} = 42\right) = 126$$

$$126 + \left(\frac{126}{2} = 63\right) = 189$$

Similarly,

$$48 + \left(\frac{48}{2} = 24\right) = 72$$

$$72 + \left(\frac{72}{2} = 36\right) = 108$$

10. (4)

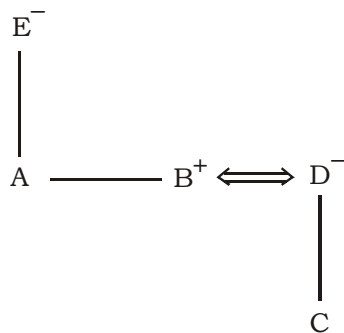

Hence, A's mother E is grand-mother of C.

11. (3) **ab**cd/**d**efg/**g**hij

12. (1) $4 \Rightarrow 4^3 - 4^2 = 48$

$$5 \Rightarrow 5^3 - 5^2 = 100$$

$$6 \Rightarrow 6^3 - 6^2 = 180$$

13. (2) $24 + 4 - 5 \times 7 \div 9 = -20$

After Changing the signs,

$$24 \div 4 - 5 \times 7 + 9 = -20$$

$$6 - 5 \times 7 + 9 = -20$$

$$6 - 35 + 9 = -20$$

$$-20 = -20$$

14. (4) In these two positions one of the common face having one part in the same position. Therefore according to the rule of dice, there will be four points on the required face.

15. (1) 4. Illness → 6. Doctor → 2. Diagnosis → 3. Prescription → 1. Medicine → 5. Recovery

16. (3) As,

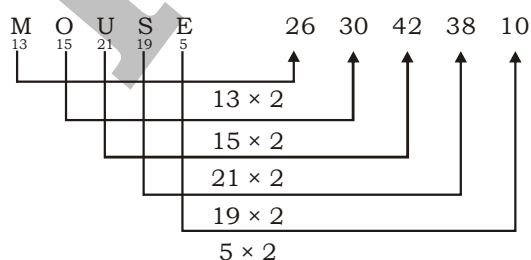

Similarly,

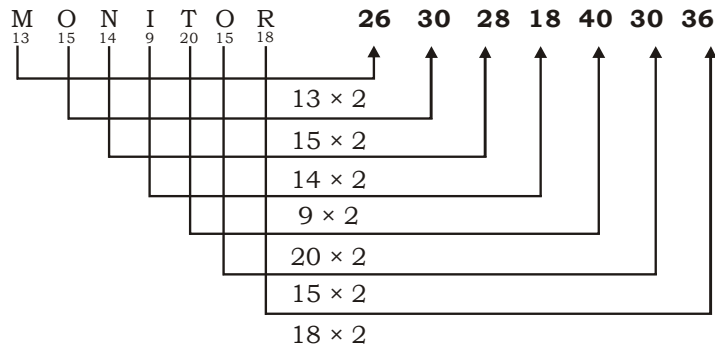

17. (2)

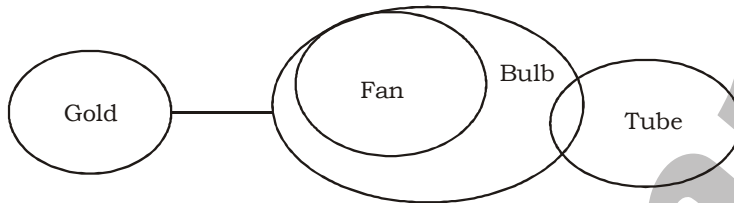

I. False II. False III. False
Hence, no conclusion follows.

18. (4)

19. (4)

20. (2)

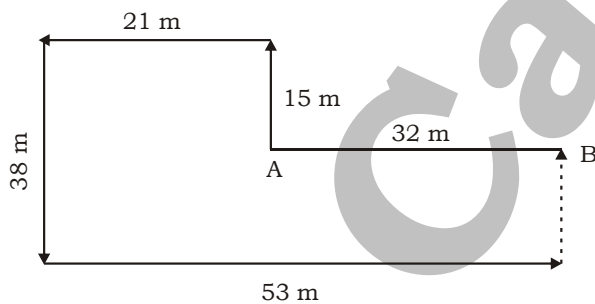

Hence, from the above diagram he should walk $(38 - 15) = 23$ m to the left.

21. (1)



Required value of $n = 40 + 15 + 25 = 80$

22. (2)

23. (4)

24. (4)

25. (1)

26. (1)

This effort culminating in 1872 has been popularly labeled as the first population census of India. However, the first synchronous census in India was held in 1881. Since then, censuses have been undertaken uninterruptedly once every ten years.

28. (4)

Tech giant Google Wednesday unveiled a new app 'Bolo' that aims to help children in primary school learn to read in Hindi and English. The free app, which is being launched in India first, uses Google's speech recognition and text-to-speech technology.

29. (1)

The kelvin is the SI unit of thermodynamic temperature, and one of the seven SI base units. Unusually in the SI, we also define another unit of temperature, called the degree Celsius ($^{\circ}\text{C}$).

31. (3) Microwaves are used in radars because they can pass through any object.
32. (3) 'Jamming' refers to hitting the tennis ball straight to the opponent's body not allowing them to extend the racquet to hit the ball well. Some of the other popular terms associated with lawn tennis are Ace, Back-court, Deuce, Double Fault, etc.
33. (3) Mahaweli Ganga, (Sinhalese: "Great Sandy River"), river, central and eastern Sri Lanka. At 208 mi (335 km) in length, it is Sri Lanka's longest river.
34. (2) Pandit Budhaditya Mukherjee is an Indian classical sitar and surbahar maestro of the Imdadkhani gharana (school), recognizable by his intricate vocalic playing complemented by spectacular high speed playing.
35. (2) The first defence minister of independent India was Baldev Singh Chokkar, who served in Prime Minister Jawaharlal Nehru's cabinet during 1947-52.
36. (3) Prime Minister Narendra Modi is set to pay a two-day visit to Dubai this week to attend World Climate Action Summit, which is part of the 28th meeting of the United Nations 'Conference of the Parties' on climate, known as COP28.
37. (3) Jaya Pal was a famous ruler from Hindushahi Dynasty, which extended from Punjab to Kabul. He ruled the Hindu Shahi kingdom from 964 to 1001 CE. He was defeated by Mahmud of Ghazni (997-1030) in Ghazni's first attack in the year 1000 AD.
38. (2) The upper part of the mantle becomes solid. The outermost layer, called the crust, is solid, too. Together, these solid parts are called the lithosphere. Earth's crust is made up of hard rocks.
40. (1) The tear glands (lacrimal glands), located above each eyeball, continuously supply tear fluid that's wiped across the surface of your eye each time you blink your eyelids.
42. (4) The correct answer is option 2 i.e. Electrons. The atom has a very basic structure in which the central part is made up of positively charged particles called protons neutrally charged particles called neutrons.
43. (1) Maharashtra is known for its Warli folk paintings. Warli is the name of the largest tribe found on the northern outskirts of Mumbai, in Western India. Despite being in such close proximity of the largest metropolis in India, Warli tribesmen shun all influences of modern urbanization.
44. (4) The greatest ruler of the Pratihara dynasty was Mihir Bhoja. He recovered Kanauj (Kanyakubja) by 836, and it remained the capital of the Pratiharas for almost a century. He built the city Bhojpal (Bhopal).
45. (1) The Speaker shall decide whether a question, or a part thereof, is or is not admissible under these rules and may disallow any question, or a part thereof, when in his opinion it is an abuse of the right of questioning or is calculated to obstruct or prejudicially affect the procedure of the House.
- 46 (1) Gymnosperms are the flowerless plant that produces cones and seeds. The term gymnosperm literally means "naked seed," as gymnosperm seeds are not encased within an ovary.
48. (3) Lucknow, in Uttar Pradesh (India), is the centre of chikankari , a skill of more than 200 years old. It literally means 'embroidery'.
50. (2) The Cairns Group is an interest group of 19 agricultural exporting countries, including Argentina, Australia, Brazil and Canada.
51. (1) P = ₹ 15000
R = 12%
T = 6 years

$$\text{Simple interest} = \frac{15000 \times 12 \times 6}{100} = ₹ 10800$$

$$\text{Amount} = 15000 + 10800 = ₹ 25800$$

For person A,

$$P = ₹ 25800$$

$$R = 10\%$$

$$T = 2 \text{ years}$$

$$\text{Compound interest} = 25800 \left(1 + \frac{10}{100}\right)^2 - 25800$$

$$= 25800 \times \frac{11}{10} \times \frac{11}{10} - 25800$$

$$= 31218 - 25800 = ₹ 5418$$

For person B,

$$P = ₹ 25800$$

$$R = 15\%$$

$$T = 2 \text{ years}$$

$$SI = \frac{25800 \times 15 \times 2}{100} = ₹ 7740$$

$$\therefore \text{Required difference} = 7740 - 5418 = ₹ 2322$$

52. (3) Let the height of the glass be h cm.

$$\text{Radius} = \frac{h}{2} \text{ cm}$$

Volume of glass = Volume of 32000 drops

$$\frac{1}{3} \pi \times \left(\frac{h}{2}\right)^2 \times h = \frac{4}{3} \pi \times \left(\frac{1}{20}\right)^3 \times 32000$$

$$\frac{h^3}{4} = 4 \times \frac{1}{8000} \times 32000$$

$$h^3 = 4 \times 4 \times 4$$

$$\therefore h = 4 \text{ cm}$$

53. (4) Required number of new science book = $(120000 + 30000) \times \frac{45}{100} - 120000 \times \frac{40}{100}$

$$= 150000 \times \frac{45}{100} - 120000 \times \frac{40}{100} = 67500 - 48000 = 19500$$

54. (3) Let the total distance be 100 km.

$$\therefore \text{Average speed} = \frac{\text{Total distance}}{\text{Total time}} = \frac{100}{\frac{30}{60} + \frac{60}{80} + \frac{10}{120}} = \frac{100}{\frac{1}{2} + \frac{3}{4} + \frac{1}{12}}$$

$$= \frac{100}{\frac{6+9+1}{12}} = \frac{100}{16} \times 12 = \frac{1200}{16} = 75 \text{ km/hr}$$

$$55. (1) \quad \frac{1}{\sqrt[3]{9} + \sqrt[3]{3} + 1} = \sqrt[3]{9}a + \sqrt[3]{3}b + c$$

$$\frac{1}{3^{\frac{2}{3}} + 3^{\frac{1}{3}} + 1} = 3^{\frac{2}{3}}a + 3^{\frac{1}{3}}b + c$$

$$\frac{\left(3^{\frac{1}{3}} - 1\right)}{\left[\left(3^{\frac{1}{3}}\right)^2 - 3^{\frac{1}{3}} + 1^2\right]\left(3^{\frac{1}{3}} - 1\right)} = 3^{\frac{2}{3}}a + 3^{\frac{1}{3}}b + c$$

$$\frac{\left(3^{\frac{1}{3}} - 1\right)}{\left[\left(3^{\frac{1}{3}}\right)^3 - 1^3\right]} = 3^{\frac{2}{3}}a + 3^{\frac{1}{3}}b + c$$

$$\frac{3^{\frac{1}{3}}}{2} - \frac{1}{2} = 3^{\frac{2}{3}}a + 3^{\frac{1}{3}}b + c$$

By comparing, we get

$$a = 0, b = \frac{1}{2} \text{ and } c = -\frac{1}{2}$$

$$\therefore 5a - 4b + 8c = 5 \times 0 + 4 \times \frac{1}{2} + 8 \times -\frac{1}{2}$$

$$= 2 - 4 = -2$$

$$56. (2) \quad \frac{\sin A \cdot \tan A}{1 - \cos A} = \frac{\sin A \cdot \frac{\sin A}{\cos A}}{1 - \cos A}$$

$$= \frac{\sin^2 A}{\cos A(1 - \cos A)} = \frac{1 - \cos^2 A}{\cos A(1 - \cos A)}$$

$$= \frac{(1 - \cos A)(1 + \cos A)}{\cos A(1 - \cos A)} = \frac{1 + \cos A}{\cos A}$$

$$= \frac{1}{\cos A} + \frac{\cos A}{\cos A} = 1 + \sec A$$

$$57. (4) \quad 5.8 + (7.4 \div 3.7 \times 5) - 6 \times 2 \div 2.5$$

$$= 5.8 + (2 \times 5) - 6 \times 2 \div 2.5$$

$$= 5.8 + 10 - 6 \times 2 \times \frac{1}{2.5}$$

$$= 5.8 + 10 - 4.8$$

$$= 15.8 - 4.8 = 11$$

58. (3) Let the price of sugar be ₹ 100.

$$\text{Price of sugar after increased by 25\%} = 100 \times \frac{125}{100} = ₹ 125$$

A person wants his expenditure increased by only 15%.

$$\text{So, his expenditure} = 100 \times \frac{115}{100} = ₹ 115$$

$$\begin{aligned} \therefore \text{Required percentage to decrease his expenditure} &= \left(\frac{125 - 115}{125} \times 100 \right) \% \\ &= \left(\frac{10}{125} \times 100 \right) \% = 8\% \end{aligned}$$

59. (2) LCM of 5, 6 and 8 = 120

$$120 = 2 \times 2 \times 2 \times 5 \times 3 = 2^2 \times 2 \times 5 \times 3$$

To make $2^2 \times 2 \times 5 \times 3$ a perfect square, we need to multiple it with $2 \times 5 \times 3$.

$$\text{Required number} = 2^2 \times 5^2 \times 3^2 \times 2^2 = 3600$$

60. (1) Let the value of B = x

$$\text{Value of A} = x \times \frac{125}{100} = 1.25x$$

$$\text{Value of C} = (x + 1.25x) \times \frac{70}{100} = 2.25x \times \frac{70}{100} = 1.575x$$

ATQ,

$$\text{Average of A, B and C} = \frac{x + 1.25x + 1.575x}{3}$$

$$765 = \frac{3.825x}{3}$$

$$x = \frac{765 \times 3}{3.825} = 600$$

$$\therefore \text{Value of A} = 600 \times \frac{125}{100} = 750$$

61. (4) P can complete the work now = $\frac{24}{80} \times 100 = 30$ days

Q can complete the work now = $\frac{18}{40} \times 100 = 45$ days

Let the total work = 90 units

P can do the work in 1 day = $\frac{90}{30} = 3$ units

Q can do the work in 1 day = $\frac{90}{45} = 2$ units

$$\therefore \text{Time taken by P and Q work together} = \frac{90}{3+2} = 18 \text{ days}$$

62. (3)

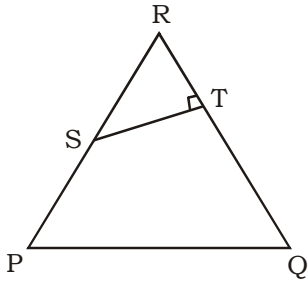

$\angle STR = 90^\circ$, $ST = 22$ cm and $RT = 8$ cm

$$\tan R = \frac{ST}{RT} = \frac{22}{8} = 2.75$$

$$\tan \angle PQR = 2.75$$

Now, $\angle PRQ = \angle PQR$ (i)

So, $PR = PQ$

$$\angle PRQ + \angle TSR = 90^\circ$$

$$2\angle PRQ + 2\angle TSR = 180^\circ$$
(ii)

In ΔPQR ,

$$\angle PQR + \angle QPR + \angle PRQ = 180^\circ$$

$$2\angle PRQ + \angle QPR = 180^\circ \quad [\text{From (i)}]$$

$$2\angle PRQ + \angle QPR = 2\angle PRQ + 2\angle PSR$$

$$\therefore \angle RPQ = 2\angle TSR$$

63. (1) Let the present age of A and B be $8x$ and $9x$ years respectively.

ATQ,

$$\frac{8x + 9}{9x + 9} = \frac{19}{21}$$

$$168x + 189 = 171x + 171$$

$$171x - 168x = 189 - 171$$

$$3x = 18$$

$$x = 6$$

Present age of B = $9 \times 6 = 54$ years

\therefore Present age of C = $54 - 3 = 51$ years

64. (3) Let the cost price of goods be ₹ 100.

$$\text{Marked price} = 100 \times \frac{130}{100} = ₹ 130$$

$$\text{Selling price of 60\% of goods} = 130 \times \frac{60}{100} = ₹ 78$$

$$\text{Selling price of 40\% of goods} = 130 \times \frac{40}{100} \times \frac{75}{100} = ₹ 39$$

$$\text{Total selling price} = 78 + 39 = ₹ 117$$

$$\therefore \text{Profit\%} = \left(\frac{117 - 100}{100} \times 100 \right) \% = 17\%$$

65. (2) $x + \frac{1}{x} = \sqrt{7}$

Cubing both sides,

$$x^3 + \frac{1}{x^3} + 3 \times x \times \frac{1}{x} \left(x + \frac{1}{x} \right) = (\sqrt{7})^3$$

$$x^3 + \frac{1}{x^3} + 3 \times \sqrt{7} = 7\sqrt{7}$$

$$\therefore x^3 + \frac{1}{x^3} = 7\sqrt{7} - 3\sqrt{7} = 4\sqrt{7}$$

66. (1)

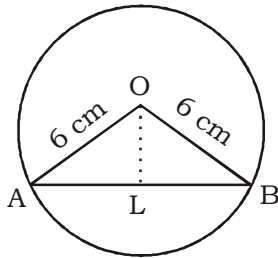

We have, $AB = 6\sqrt{3}$ cm

$$AL = BL = \frac{6\sqrt{3}}{2} = 3\sqrt{3} \text{ cm}$$

Let $\angle AOB = 2\theta$

Now, $\angle AOL = \angle BOL = \theta$

In $\triangle AOL$,

$$\sin \theta = \frac{AL}{OA} = \frac{3\sqrt{3}}{6} = \frac{\sqrt{3}}{2}$$

$$\theta = 60^\circ$$

Now, $\angle AOB = 2 \times 60^\circ = 120^\circ$

$$\therefore \text{Area of sector AOB} = \frac{\theta}{360^\circ} \times \pi r^2$$

$$= \frac{120}{360} \times \pi \times 6 \times 6 = 12\pi \text{ cm}^2$$

67. (2) Total capital of A in year = $60000 \times 3 + 40000 \times 9$

$$= 180000 + 360000 = ₹ 540000$$

Total capital of B in a year = $80000 \times 3 + 100000 \times 6$

$$= 240000 + 600000 = ₹ 840000$$

\therefore Required ratio = $540000 : 840000 = 9 : 14$

68. (3)

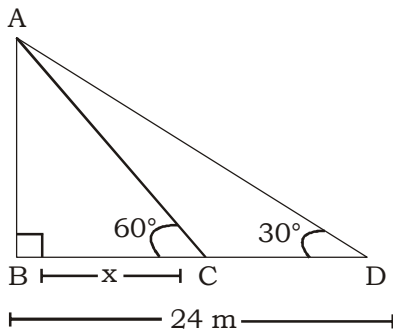

Let AB is tower and the length of shadow be x m.

In $\triangle ABD$,

$$\tan 30^\circ = \frac{AB}{BD}$$

$$\frac{1}{\sqrt{3}} = \frac{AB}{24}$$

$$AB = \frac{24}{\sqrt{3}} \text{ m} \quad \dots(i)$$

In $\triangle ABC$,

$$\tan 60^\circ = \frac{AB}{BC}$$

$$\sqrt{3} = \frac{AB}{x}$$

$$AB = x\sqrt{3} \text{ m} \quad \dots(ii)$$

Equating equation (i) and (ii), we get

$$x\sqrt{3} = \frac{24}{\sqrt{3}}$$

$$x = \frac{24}{\sqrt{3} \times \sqrt{3}} = 8 \text{ m}$$

Hence, the length of shadow is 8 m

69. (3) $(20 - x) : (37 - x) :: (54 - x) : (105 - x)$

$$\frac{20 - x}{37 - x} = \frac{54 - x}{105 - x}$$

$$2100 - 20x - 105x + x^2 = 1998 - 37x - 54x + x^2$$

$$2100 - 125x = 1998 - 91x$$

$$34x = 102$$

$$x = \frac{102}{34} = 3$$

\therefore Mean proportion between $(5x + 1)$ and $(25x + 6)$

$$= \sqrt{(5 \times 3 + 1)(25 \times 3 + 6)} = \sqrt{16 \times 81} = 36$$

70. (4) The last digit in the expansion of $(2457)^{754}$ is depend on value of 7
 When 7 raise to power 1, last digit is 7
 When 7 is raised to power 2, last digit is 9
 When 7 is raised to power 3, last digit is 3
 When 7 is raised to power, last digit is 1
 So, it repeats its last digit after every power multiple of 4 and the process continues like
 When 7 raise to power 5, last digit is 7
 When 7 raise to power 6, last digit is 9
 When 7 raise to power 7, last digit is 3
 When 7 raise to power 8, last digit is 1
- So, divide the power by 4, $\left(\frac{754}{4}\right)$, remainder is 2
- Hence, last digit is decided by power 2, i.e. 9
71. (1) Total deduction = $24800 \times \frac{10}{100} + 4540 = 2480 + 4540 = ₹ 7020$
 \therefore Net salary = $24800 + 32600 - 7020 = 57400 - 7020 = ₹ 50380$
72. (3) Basic salary and total allowance of Anil = $30850 + 5250 = ₹ 36100$
 Let the basic salary be ₹ x.
 Total allowance = ₹ (x + 5000)
 ATQ,
 $x + x + 5000 = 36100$
 $2x = 31100$
 $x = \frac{31100}{2} = ₹ 15550$
 \therefore Total allowance = $15550 + 5000 = ₹ 20550$
73. (2) Total deductions = $19200 \times \frac{10}{100} = ₹ 1920$
 \therefore Other deductions of Sunil = $\frac{1920}{20} \times 13 = ₹ 1248$
74. (4) Basic salary of Sunil = ₹ 19200
 Basic salary of Ramendra = ₹ 18400
 \therefore Required more% = $\left(\frac{19200 - 18400}{18400} \times 100\right)\% = 4.34\% \approx 4\%$
75. (2) Provident Fund deduction = $6500 - 5400 = ₹ 1100$
 Basic salary of Tara = $\frac{1100}{10} \times 100 = ₹ 11000$
 \therefore Net salary of Tara = $11000 + 38500 - 6500 = 49500 - 6500 = ₹ 43000$

MEANINGS IN ALPHABETICAL ORDER

Absurd	unreasonable, illogical, or inappropriate	बेतुका
Annihilate	destroy utterly	सर्वनाश करना
Antagonism	active hostility or opposition	सक्रिय शत्रुता या विरोध
Aversion	a strong dislike or disinclination	घृणा
Bothersome	causing irritation or annoyance	तंग करने वाला
Emphasis	special importance, value, or prominence given to something	किसी चीज को दिया जाने वाला विशेष महत्त्व, मूल्य या प्रमुखता
Ethos	the characteristic spirit of a culture, era, or community as manifested in its beliefs and aspirations	प्रकृति
Exaggerate	overstate or overemphasize	बड़ा चढ़ाकर कहना
Exhilarate	make (someone) feel very happy, animated, or elated	खुश
Idiotic	very stupid	मूर्खतापूर्ण
Ignorance	lack of knowledge or information	अज्ञान
Initiate	cause (a process or action) to begin	आरंभ करना
Innocuous	not harmful or offensive	हानि न करने वाला
Inoffensive	not objectionable or harmful	अनापत्तिजनक, स्वीकार्य
Intriguing	arousing one's curiosity or interest; fascinating	दिलचस्प
Lethargy	a lack of energy and enthusiasm	सुस्ती, आलस्य
Mundane	lacking interest or excitement; dull	उबाऊ
Naïve	(of a person or action) showing a lack of experience, wisdom, or judgment	निष्कपट
Obliterate	wipe out	मिटाना
Onslaught	a fierce or destructive attack	हमला
Overreach	the act of doing more than your authority allows	अपने अधिकार का अति प्रयोग
Praiseworthy	deserving approval and admiration	सराहनीय
Relevant	closely connected or appropriate to the matter at hand	प्रासंगिक
Revive	restore to life or consciousness	पुर्नजीवित करना
Scanty	small or insufficient in quantity or amount	थोड़ा
Swabbing	wash with a mop	झाड़ू से साफ करना
Taboo	a social or religious custom prohibiting or forbidding a particular practice	पाबंदी
Triviality	lack of seriousness or importance; insignificance	महत्वहीनता, तुच्छता

SSC MOCK TEST - 416 (ANSWER KEY)

- | | | | |
|---------|---------|---------|----------|
| 1. (3) | 26. (1) | 51. (1) | 76. (3) |
| 2. (4) | 27. (1) | 52. (3) | 77. (2) |
| 3. (1) | 28. (4) | 53. (4) | 78. (1) |
| 4. (3) | 29. (1) | 54. (3) | 79. (2) |
| 5. (2) | 30. (4) | 55. (1) | 80. (4) |
| 6. (3) | 31. (3) | 56. (2) | 81. (4) |
| 7. (1) | 32. (3) | 57. (4) | 82. (2) |
| 8. (1) | 33. (3) | 58. (3) | 83. (1) |
| 9. (3) | 34. (2) | 59. (2) | 84. (2) |
| 10. (4) | 35. (2) | 60. (1) | 85. (2) |
| 11. (3) | 36. (3) | 61. (4) | 86. (2) |
| 12. (1) | 37. (3) | 62. (3) | 87. (4) |
| 13. (2) | 38. (2) | 63. (1) | 88. (2) |
| 14. (4) | 39. (4) | 64. (3) | 89. (3) |
| 15. (1) | 40. (1) | 65. (2) | 90. (1) |
| 16. (3) | 41. (3) | 66. (1) | 91. (3) |
| 17. (2) | 42. (4) | 67. (2) | 92. (1) |
| 18. (4) | 43. (1) | 68. (3) | 93. (4) |
| 19. (4) | 44. (4) | 69. (3) | 94. (2) |
| 20. (2) | 45. (1) | 70. (4) | 95. (3) |
| 21. (1) | 46. (1) | 71. (1) | 96. (3) |
| 22. (2) | 47. (4) | 72. (3) | 97. (1) |
| 23. (4) | 48. (3) | 73. (2) | 98. (4) |
| 24. (4) | 49. (2) | 74. (4) | 99. (2) |
| 25. (1) | 50. (2) | 75. (2) | 100. (3) |

76. (3) Since, the sentence is in present tense, the 'if clause' should also be in present tense. Change 'placed' into 'place'.
77. (2) Change 'have' into 'has', as it should follow the subject of the sentence 'the popular belief'.
85. (2) 'Hang by a thread' is an idiom which means 'to be in a very dangerous situation or state; to be very close to death, failure, etc.'
86. (2) 'Call out' means 'to publicly criticize or fault someone or something.'
89. (3) The correct spelling of 'Intigrate' is 'Integrate', 'Exhilerate' is 'Exhilarate' and 'Exaggarate' is 'Exaggerate'.
90. (1) The correct spelling is 'Occasionally'.