



**K D Campus Pvt. Ltd**

2007, OUTRAM LINES, 1ST FLOOR, NEAR GTB NAGAR METRO STATION, GATE NO. - 2, DELHI-110009

**Answer-key & Solution**

SSC JE (Electrical)  
MOCK -(67)  
Date 01/10/2016

1. A	26. A	51. B	76. D	101. B	126. A	151. D	176. B
2. C	27. D	52. C	77. B	102. B	127. A	152. D	177. C
3. A	28. D	53. A	78. D	103. C	128. C	153. C	178. D
4. D	29. C	54. B	79. A	104. C	129. A	154. C	179. D
5. A	30. B	55. C	80. C	105. D	130. A	155. D	180. D
6. C	31. D	56. C	81. B	106. A	131. A	156. A	181. B
7. A	32. B	57. A	82. C	107. C	132. B	157. D	182. A
8. D	33. D	58. A	83. B	108. C	133. D	158. D	183. D
9. B	34. B	59. D	84. D	109. D	134. B	159. A	184. B
10. B	35. B	60. D	85. B	110. A	135. C	160. B	185. D
11. B	36. C	61. A	86. D	111. C	136. D	161. A	186. C
12. B	37. D	62. B	87. A	112. C	137. B	162. C	187. D
13. A	38. A	63. D	88. A	113. C	138. D	163. A	188. D
14. D	39. D	64. B	89. B	114. C	139. A	164. A	189. C
15. A	40. D	65. C	90. A	115. D	140. A	165. C	190. A
16. B	41. C	66. C	91. C	116. B	141. C	166. D	191. B
17. D	42. C	67. C	92. D	117. C	142. B	167. B	192. D
18. C	43. D	68. A	93. B	118. C	143. A	168. C	193. D
19. C	44. A	69. A	94. C	119. A	144. A	169. A	194. C
20. C	45. C	70. B	95. B	120. D	145. C	170. C	195. D
21. C	46. B	71. B	96. C	121. B	146. B	171. C	196. B
22. D	47. A	72. B	97. B	122. A	147. C	172. B	197. D
23. B	48. C	73. D	98. B	123. C	148. A	173. B	198. B
24. C	49. C	74. B	99. B	124. C	149. C	174. D	199. C
25. C	50. C	75. C	100. A	125. A	150. B	175. C	200. D

**Note :** If your opinion differ regarding any answer, please message the mock test and Question number to 8375805483

**Note :** If you face any problem regarding result or marks scored, please contact : 9313111777

**SOLUTION SSC JE (Electrical) MOCK TEST no. 67**

1. (A) Alphabetic positions of K and T are 11 and 20 respectively. Similarly positions of J and R are 10 and 18 respectively.
2. (C) As 'indolence' and 'Work' are opposite to each other, in the same way 'Taciturn' and 'Talkative' are opposite to each other.
3. (A) As the cry of 'Dog' is called 'Bark', in the same way the cry of 'Goat' is called 'Bleat'.

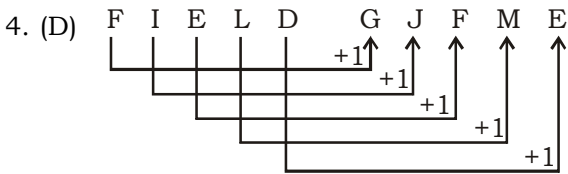

Similarly,

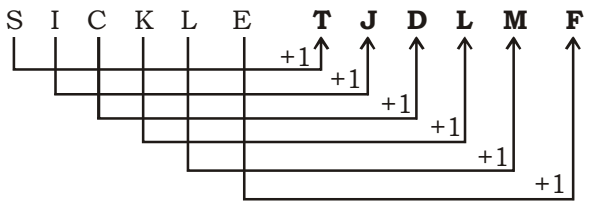

5. (A) 'Jade' is a 'Green' coloured precious stone, in the same way 'Garnet' is a 'Red' coloured precious stone.
6. (C) As 'Knowledge' is achieved by 'Reading', in the same way 'Experience' is achieved by 'Work'.
7. (A) As,  $61 = (4)^3 - 3$      $121 = (5)^3 - 4$   
and  $337 = (7)^3 - 6$   
Therefore,  $? = (6)^3 - 5 = 211$
8. (D) As the dwelling place of 'Rabbit' is 'Burrow' in the same way the dwelling place of 'Lunatic' is 'Asylum'.

9. (B) K e a C    C a e K  
1 2 3 4    4 3 2 1

Similarly,  
X g m F    F m g X  
1 2 3 4    4 3 2 1

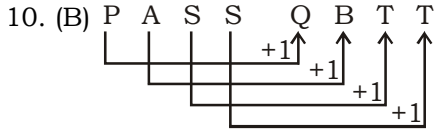

Similarly,

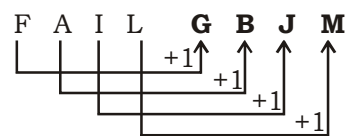

11. (B) Only **Television** is audio-visual.
12. (B) In each number except **383**, the product of first and third digit is the middle one.
13. (A) All except Chicken can go into water.
14. (D) All except **Ayurveda** are the names of Vedas. Ayurveda is a branch of medicine.
15. (A) All except **Potassium** are metals used in semiconductor devices.
16. (B) B must be the odd box as three of the boxes have odd numbers of lines whereas box B contains even number of lines.
17. (D) Position of S = (19) and  $19 \times 19 = 361 \neq 351$   
Position of E = (5) and  $5 \times 5 = 25$   
Position of I = (9) and  $9 \times 9 = 81$   
Position of X = (24) and  $24 \times 24 = 576$

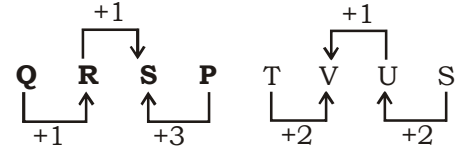
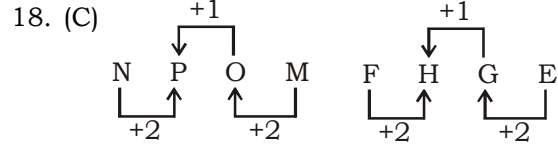

19. (C)

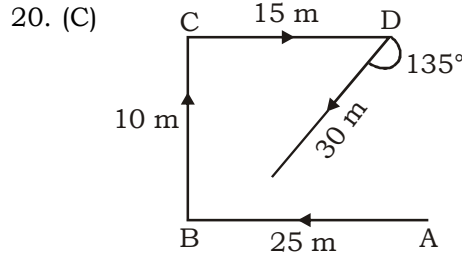

Hence he is going in the South-West direction.

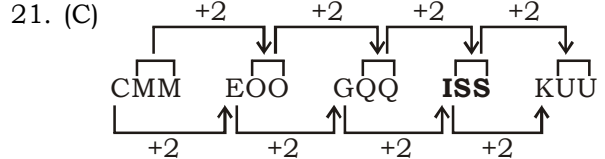

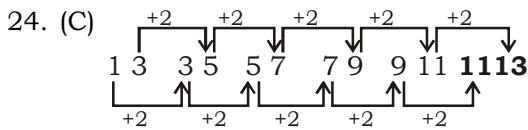
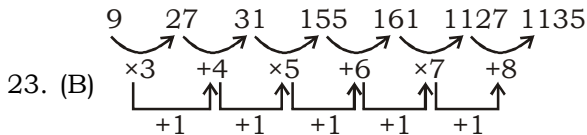
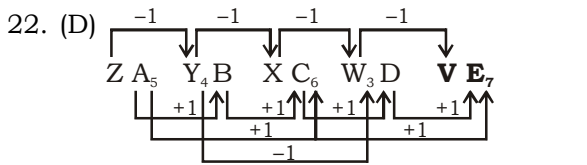

25. (C) Blackboard is in Class and Class is in the School.  
 26. (A) A is the mother of B, B is the brother of C and C is the daughter of D. Hence, D is the father.

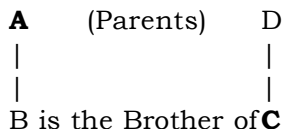

Here, the one which are bold are females (A, C) and not bold are males (B, D).

27. (D) From *wilkospadi*, we can determine that *wilko* means bicycle and *spadi* means race. So, the first part of the word that means race car should begin with *spadi*. As the word *wilko* means bicycle. Therefore, the answer must be choice d, *spadivolo*.  
 28. (D) According to the statement, 80% of the total runs were made by spinners. So, I does not follow. Nothing about the opening batsmen is mentioned in the statement. So, II also does not follow.  
 29. (C) The correct order is :  
 Advertisement Application Interview  
 (5) → (6) → (2)  
 Selection Appointment  
 Probation  
 (3) → (4) → (1)

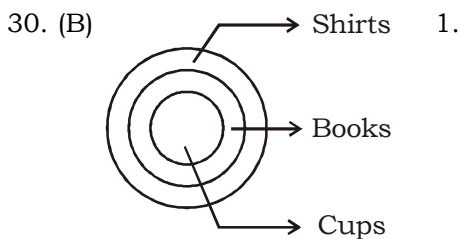

31. (D)  $(3)^2 = 9$        $(4)^2 = 16$   
 $(5)^2 = 25$        $(6)^2 = 36$

$(7)^2 = 49$        $(8)^2 = 64 \neq 61$

32. (B) Only son of Neha grand father means father of Neha. Therefore, Neha is sister of Vivek.

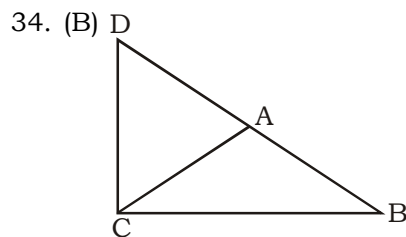
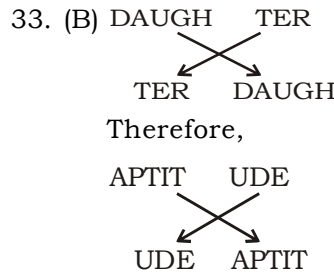

So, with reference to A, B is located in South-East direction.

35. (B)  $15 \times 5 \div 3 = 25$

LHS =  $\frac{15 \times 5}{3} = 25 = \text{RHS}$

36. (C)

Number of dots on top face	•	••	•••
Number of dots on bottom face	•	•••	••••

So, we can find 3 points opposite to the face with 4 points.

37. (D) Let salary = ₹  $x$ , then tips = ₹  $\left(\frac{5}{4}x\right)$ .

Total income = ₹  $\left(x + \frac{5}{4}x\right) = ₹ \left(\frac{9x}{4}\right)$ .

∴ Required fraction =  $\left(\frac{5x}{4} \times \frac{4}{9x}\right) = \frac{5}{9}$ .

38. (A) F3M → F is the wife of M  
 M5K → M is the father of K  
 ∴ F is the mother of K = **F3M5K**  
 39. (D) The digits are removed one by one from the beginning and the end in order alternately so as to obtain the subsequent terms of the series.  
 So, ? = 96542

40. (D)

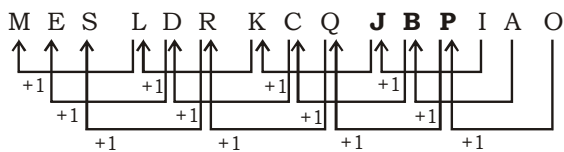

41. (C) Using the correct symbols, we have the given expression as

$$20 + 8 - 8 \div 4 \times 2 = 20 + 8 - 2 \times 2 \\ = 20 + 8 - 4 = \mathbf{24}.$$

42. (C) The colour of the human blood is 'red'.  
As it is given that 'red' is called 'yellow'.  
So, the colour of human blood is 'yellow'.

43. (D)

44. (A)

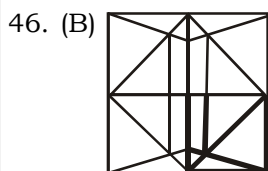
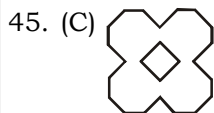

47. (A) 1, 4 and 7 are quadrilaterals.  
2, 5 and 8 are three-dimensional figures.  
3, 6 and 9 are triangles.

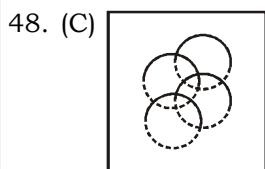

49. (C) The third figure in each row comprises the parts common to the first two figures.

50. (C)

54. (B) Natural Calamities are sudden "acts of god," which cannot be anticipated and planned. So budgetary approvals are not needed in this case. A budget is normally a statement of revenue receipts and expenditure. An appropriation bill or running bill is a legislative motion (bill) which authorizes the government to spend money. It is a bill that sets money aside for specific spending.

58. (A) Arya Samaj is a Hindu reform movement founded by Swami Dayananda in Bombay on 7 April, 1875. The membership amounted to 100 persons, including Swami Dayanand. On the 24th of June, 1877, the second major Arya Samaj was established at Lahore.

59. (D) The Fourth Five-Year Plan (1969-1974) set before itself the two principal objectives - growth with stability and progress towards self-reliance. It laid great emphasis on agriculture's growth rate so that a chain reaction can start. The Fifth Five-Year Plan (1974-1979) also focused on self-reliance in agricultural production and defense.

60. (D) Light year is a unit of length used informally to express astronomical distances. It is most often used when expressing distances to stars and other distances on a galactic scale. It is equal to just under 10 trillion kilometres.

64. (B) After joining the Congress Party and taking part in political agitation in the Punjab, Lala Lajpt Rai was deported to Mandalay, Burma (Myanmar) without trial in May 1907. In November, however he was allowed to return when the viceroy Lord Minto decided that there was insufficient evidence to hold him for subversion.

66. (C) Article 15 of the constitution states that no person shall be discriminated on the basis of caste, colour, language etc. Every person shall have equal access to public places like public parks, museums, wells, bathing ghats and temples etc. However, the state may make any special provisions for women and children. Special provisions may be made for the advancements of any socially or educationally backward class or scheduled castes or scheduled tribes.

67. (C) Seasonal employment refers to a situation where a number of persons are not able to find jobs during some months of the year. Example: Agriculture is a seasonal activity. There is an increased demand for labour at the time for sowing, harvesting, weeding and threshing. In between there is little or no demand for labour. Besides this disguised unemployment is also seen in agriculture in India.

68. (A) Article 222 empowers the President to transfer judges from one High Court to another. Clause (2) of this article goes on to provide that when a judge is transferred he shall be entitled to receive a compensatory allowance in addition to his salary. It is felt that there is no real justification for granting such an

- |  |  |
|--|--|
| <p>allowance and it is accordingly proposed to omit clause.</p> <p>69. (A) Robert Edwin Peary was an American explorer who claimed to have led the first expedition, on April 6, 1909, to reach the geographic North Pole. Peary's claim was widely credited for most of the 20<sup>th</sup> century, though it was criticized even in its own days.</p> <p>71. (B) CSIR- Central Food Technological Research Institute, abbreviated to CSIR-CFTRI which is one of the 40 national research laboratories in India was set up under the aegis of the Council of Scientific and Industrial Research (CSIR). It is Located in Mysore (Karnatka) and was opened in 1950.</p> <p>72. (B) Disinvestment is a process where Government sells its equity holding to private sectors. In other ways it is a privatization process where private parties are given shareholding in Government undertakings either wholly or partially.</p> <p>73. (D) A modem (modulator-demodulator) is a device that modulates an analog carrier signal to encode digital information and also demodulates such a carrier signal to decode the transmitted information. The goal is to produce a signal that can be transmitted easily and decoded to reproduce the original digital data.</p> <p>74. (B) Bank of India is an Indian state-owned commercial bank with headquarters in Mumbai (Maharashtra). It has been government-owned since nationalization in 1969. It is India's 4th largest PSU bank after State Bank of India, Punjab National Bank and Bank of Baroda.</p> <p>77. (B) The Nobel Peace Prize is one of the five Nobel Prizes bequeathed by the Swedish industrialist, inventor and armaments manufacturer Alfred Nobel, along with the prizes in Chemistry, Physics, Physiology or Medicine and Literature. Since 1901, it has been awarded annually (with some exceptions) to those who have done the most or the best work for fraternity between nations, for the abolition or reduction of standing armies and for the holding and promotion of peace. Nobel Prize is not given in Mathematics.</p> <p>78. (D) The Hypertext Transfer Protocol (HTTP) is an application protocol for distributed,</p> | <p>collaborative, hypermedia information systems. HTTP is the foundation of data communication for the World Wide Web. HTTP is the protocol to exchange or transfer hypertext.</p> <p>82. (C) Water is a good solvent due to its high polarity. The solvent properties of water are vital in biology, because many biochemical reactions take place only within the aqueous solutions.</p> <p>83. (B) London is situated on the banks of River Thames which is the longest river entirely in England and the second longest in the United Kingdom.</p> <p>84. (D) Christopher Cockerell invented the hovercraft in 1956. His early experiments with the idea involved a cat food tin, a coffee tin and an industrial blower.</p> <p>85. (B) The IEEE (Institute of Electrical and Electronics Engineers) was formed in 1963 by the merger of the Institute of Radio Engineers (IRE, founded 1912) and the American Institute of Electrical Engineers (AIEE, founded 1884).</p> <p>86. (D) Acetylene is an inflammable gas which triggers artificial ripening process in fruits. Usually fruits produce ethylene gas and a plant hormone that naturally lead to their ripening.</p> <p>91. (C) An important function of the Reserve Bank of India is to act as Government banker, agent and adviser. The Reserve Bank is an agent of Central Government and of all State Governments in India except J&amp;K. State Government transactions are carried out by RBI in terms of the agreement entered into with the State Governments by section 21A of the Reserve Bank of India Act. 1934.</p> <p>92. (D) The presence of Mongoloid groups in North-East India had been attested as early as circa 500 BC in ancient Indian literature. The diverse Mongoloid groups which eventually settled in different habitats and ecological settings crystallized into distinct tribal societies.</p> <p>93. (B) Bara Imambara is an imambara complex in Lucknow built by Asaf-ud-Daulah (Nawab of Lucknow) in 1784. It is also called the Asafi Imambara. Bara means big and an imambara is a shrine built by Shia Muslims for the purpose of Azadari.</p> |
|--|--|

107. (B) Power delivered by current source  
 $= 1 \times 1 = 1\text{W}$ .

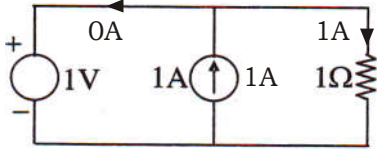

Power dissipated (consumed) by resistance  $= 1 \times 1 = 1\text{W}$

Power delivered by 1V source  
 $= 1\text{V} \times 0\text{A} = 0\text{W}$ .

Note that power is not consumed but delivered by the current source.

102. (B)  $C = 0.1\mu\text{F}$

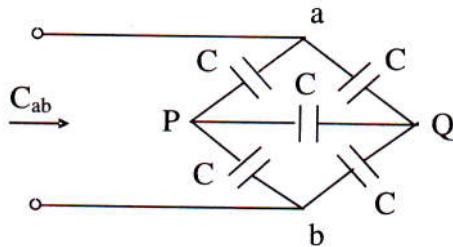

The given circuit is a balanced bridge as shown in Fig.

$$V_{PQ} = 0$$

P and Q are shorted

$$\begin{aligned} \therefore C_{ab} &= (C \parallel C) \text{ in series with } (C \parallel C) \\ &= 2C \text{ in series with } 2C \\ &= C = 0.1\mu\text{F} \end{aligned}$$

103. (C) The open circuit voltage  $V_{AB} =$  Source voltage 100 V. As no current flows through  $30\Omega$ , Z is found by shorting 100V and opening 2A, then  $Z_{AB} = Z = 30\Omega$

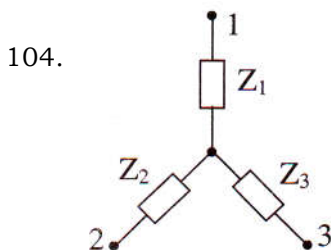

For the Y- equivalent shown in Fig.

$$Z_1 = \frac{j5 \times j5}{j5 + j5 - j5} = -\frac{25}{j5} = j5$$

$$Z_2 = \frac{j5 \times (-j5)}{j5} = -\frac{25}{j5} = -j5$$

$$Z_3 = \frac{(-j5) \times (j5)}{j5} = -\frac{25}{j5} = -j5$$

105. (D)

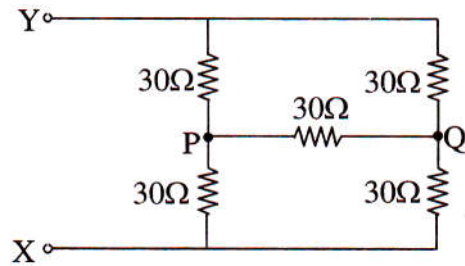

The given circuit is a balanced bridge as shown in Fig.

$\therefore$  P and Q are shorted.

$$\begin{aligned} \text{Then } R_{XY} &= (30\Omega \parallel 30\Omega) (30\Omega \parallel 30\Omega) \\ &= 30\Omega \end{aligned}$$

106. (A)  $\tau = RC$ ,  $R = 2\Omega \parallel 3\Omega = \frac{6}{5}\Omega$ ,  $C = 5\mu\text{F}$

$$\tau = \frac{6}{5} \times 5\mu = 6\mu\text{s}$$

Note that  $V_{dc}$  is shorted to calculate R.

107. (C) By opening the current sources and shorting the voltage source,

$$R_{th} = \frac{5 \times 1}{5 + 1} = \frac{5}{6}\Omega$$

$$\therefore R = \frac{5}{6}\Omega$$

108. (C)  $Z_i = (9 + 12)\Omega$

For maximum power transfer, resistive load,

$$R_L = \sqrt{R_i^2 + X_i^2} = \sqrt{9^2 + 12^2} = 15\Omega$$

109. (D)  $i_L(i) = i_L(0^+) = i_L(0) = 0$ , as the current through the inductor cannot change instantaneously.

110. (A)  $\omega L = 1000\omega$ ,  $\frac{1}{\omega C} = 1000\Omega$ ,

$$R = 0.1\Omega, f_0 = 10\text{MHz}$$

As  $\omega L = \frac{1}{\omega C}$ , the circuit is resonant.

For series resonant circuit,

$$Q = \frac{\omega_0 L}{R} = \frac{1000}{0.1} = 10^4$$

Bandwidth =

$$\frac{f_0}{Q} = \frac{10 \times 10^6}{10^4} \text{Hz} = 1\text{kHz}$$

111. (D) Inductance,  $L \propto \frac{N^2 A}{F}$

But  $A = \frac{\pi d^2}{4}$

$\therefore L \propto \frac{N^2 d^2}{F}$

112. (C)

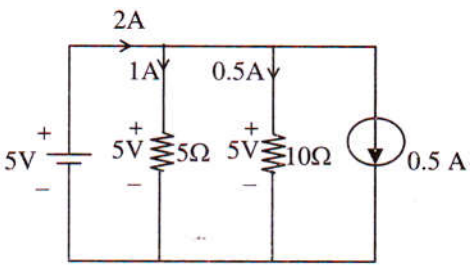

$R = \frac{V}{I} = \frac{5}{2} = 2.5 \Omega$

113. (C) The given network can be redrawn as

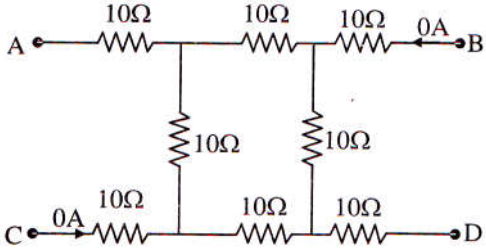

The above circuit can be redrawn as shown below.

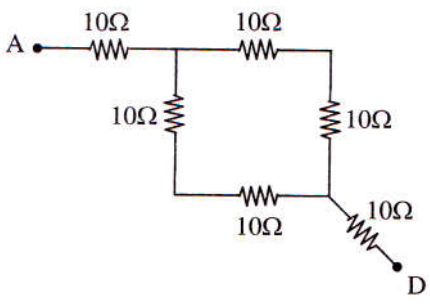

$R_{AD} = 10 + 20 // 20 + 10$   
 $R_{AD} = 30 \Omega$

114. (C)  $P = I_{RMS}^2 \cdot R$

$= \left[ \frac{9}{\sqrt{3}} \right]^2 \cdot 20 = \frac{81}{3} \times 20 = 540 \text{ W}$

115. (D) The value of the unknown resistance measured by Wheatstone bridge is independent of the source voltage.

129. (A) Apply KVL

$V_0 = -3 \text{ V}$

Current  $= \frac{V}{I} = \frac{+3 - (-3)}{10} = \frac{6}{10}$   
 $= 0.6 \text{ mA}$

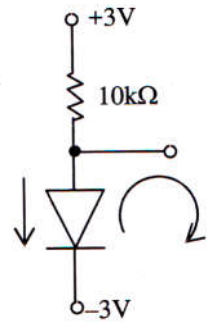

130. (A)  $E = \frac{V}{d}$

$= \frac{0.5}{5 \times 10^{-7}}$   
 $= 1 \times 10^6 \text{ V/m}$

131. (A)

$\Delta R = \frac{\Delta V}{\Delta I} = \frac{V_2 - V_1}{I_2 - I_1} = \frac{30\text{m} - 20\text{m}}{30\text{m} - 5\text{m}} = \frac{40\text{m} - 30\text{m}}{I_c - 30\text{m}}$

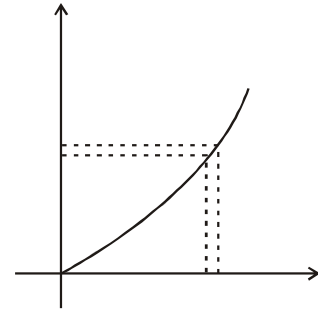

148. (A)  $R_1 = 10 \pm 5\% \Omega$

$R_2 = 5 \pm 10\% \Omega$

Tolerance in  $R_1 = 5\%$  of  $10 \Omega = \pm 0.5 \Omega$

Tolerance in  $R_2 = 10\%$  of  $5 \Omega = \pm 0.5 \Omega$

$R_1 = 9.5 \Omega$  to  $10.5 \Omega$

$R_2 = 4.5 \Omega$  to  $5.5 \Omega$

The range of parallel combination

of  $R_1$  and  $R_2 = \frac{R_1 \cdot R_2}{R_1 + R_2}$

$= \frac{9.5 \cdot 4.5}{9.5 + 4.5} \text{ W to } \frac{10.5 \cdot 5.5}{10.5 + 5.5}$   
 $= 3.06 \Omega$  to  $3.6 \Omega$