



**Campus**  
**K D Campus Pvt. Ltd**

2007, OUTRAM LINES, 1ST FLOOR, NEAR GTB NAGAR METRO STATION, GATE NO. - 2, DELHI-110009

**Answer-key & Solution**

**SSC JE (Electrical)**  
**Practice Set-7**

1. A	26. C	51. B	76. C	101. D	126. C	151. C	176. A
2. D	27. B	52. A	77. C	102. D	127. B	152. A	177. C
3. C	28. A	53. B	78. C	103. B	128. D	153. B	178. A
4. B	29. A	54. D	79. B	104. B	129. C	154. B	179. C
5. B	30. A	55. C	80. C	105. D	130. C	155. D	180. C
6. B	31. B	56. A	81. D	106. D	131. C	156. D	181. B
7. A	32. C	57. C	82. D	107. C	132. C	157. D	182. B
8. A	33. B	58. B	83. C	108. B	133. A	158. C	183. B
9. C	34. C	59. A	84. B	109. B	134. D	159. D	184. B
10. C	35. A	60. A	85. C	110. C	135. C	160. D	185. D
11. C	36. C	61. D	86. A	111. B	136. B	161. A	186. B
12. D	37. B	62. B	87. C	112. A	137. D	162. A	187. C
13. D	38. A	63. D	88. D	113. C	138. B	163. D	188. D
14. D	39. A	64. D	89. C	114. C	139. C	164. D	189. C
15. D	40. B	65. B	90. A	115. B	140. A	165. A	190. C
16. C	41. D	66. C	91. A	116. A	141. D	166. C	191. D
17. C	42. C	67. D	92. C	117. D	142. C	167. A	192. A
18. C	43. C	68. C	93. D	118. A	143. C	168. A	193. A
19. B	44. B	69. A	94. A	119. D	144. D	169. A	194. A
20. D	45. B	70. A	95. C	120. B	145. D	170. A	195. C
21. A	46. A	71. C	96. A	121. B	146. C	171. C	196. B
22. C	47. C	72. C	97. B	122. D	147. C	172. A	197. C
23. B	48. B	73. B	98. A	123. A	148. A	173. C	198. D
24. B	49. B	74. C	99. A	124. A	149. B	174. B	199. C
25. A	50. B	75. B	100. D	125. A	150. A	175. A	200. A

**Note :** If your opinion differ regarding any answer, please message the mock test and Question number to 9560620353

**Note :** If you face any problem regarding result or marks scored, please contact : 9313111777



$$\sqrt{1296} + \sqrt{576} + \sqrt{100} = 36 + 24 + 10 = 70$$

26. (C) 
$$\begin{array}{ccc} 8-5 & 9-6 & 5-2 \\ \downarrow & \downarrow & \downarrow \\ \boxed{3} & \boxed{3} & \boxed{3} \end{array}$$

$$\begin{array}{ccc} 8-2 & 10-4 & 15-9 \\ \downarrow & \downarrow & \downarrow \\ \boxed{6} & \boxed{6} & \boxed{6} \end{array}$$

$$\begin{array}{ccc} 6-3 & 15-9 & 14-12 \\ \downarrow & \downarrow & \downarrow \\ \boxed{3} & \boxed{6} & \boxed{2} \end{array}$$

27. (B)  $(2 + 6 + 2 + 3)^2 - 1 = 168$   
 $(3 + 5 + 1 + 2)^2 - 1 = 120$   
 $(2 + 3 + 5 + 4)^2 - 1 = \mathbf{195}$

28. (A) 
$$\frac{\text{Leopard}}{6} \quad \frac{\text{Load}}{4} \quad \frac{\text{Loan}}{3} \quad \frac{\text{Loath}}{1} \quad \frac{\text{Long}}{2}$$
  
Luminous  
 5

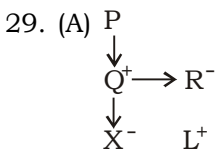

So, L is grandson of P.

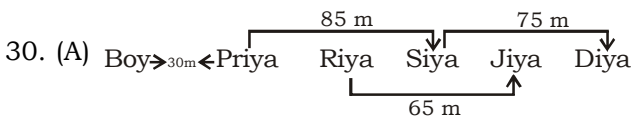

Required distance =  $30 + 85 + 65 = 180$  m

31. (B)  
32. (C)

33. (B) 
$$\frac{\text{Stone}}{5} \quad \frac{\text{Rock}}{1} \quad \frac{\text{Hill}}{2} \quad \frac{\text{Mountain}}{3} \quad \frac{\text{Range}}{4}$$

34. (C) Let the number of boys be  $x$ .  
 $2x + 4(7-x) = 20$   
 $2x + 28 - 4x = 20$   
 $8 = 2x$   
 $4 = x$   
 Then, number of dogs =  $7 - 4 = 3$

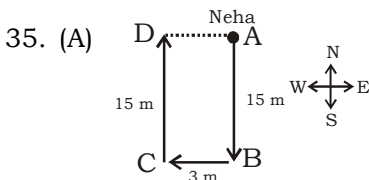

Hence, Neha is facing towards the North direction.

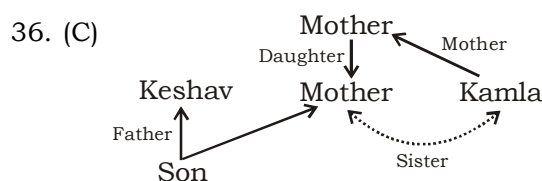

37. (B) Rahul : Rani =  $1x : 10x$   
 Today =  $1x + 10x + \frac{10 \text{ yrs}}{5 \text{ yrs of each}} = 32 \text{ yrs.}$   
 $11x = 22$   
 $x = 2$

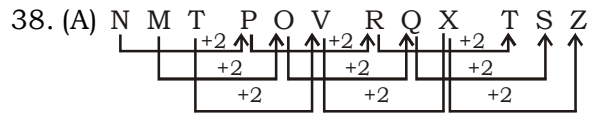
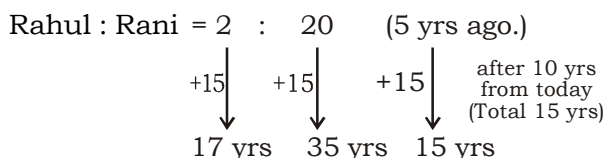

39. (A) 
$$\begin{array}{cccccc} 2 & 6 & 12 & 20 & 30 & 42 & 56 \\ \downarrow & \downarrow & \downarrow & \downarrow & \downarrow & \downarrow & \downarrow \\ +4 & +6 & +8 & +10 & +12 & +14 & \end{array}$$

40. (B)  $a a \underline{a} / b a a \underline{b} / a a \underline{a} / b a \underline{a} b$   
 41. (D)  $b a a \underline{b/b} a a b / \underline{b} a a b / b \underline{a} a b$   
 42. (C) People who don't play any game

=  $40 - (25 + 22 - 16)$   
 =  $40 - 31 = 9$

43. (C) Three meaningful word-  
**ELECTION**  
**ELECTRON**  
**ELECTRIC**

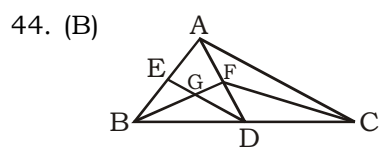

There are 13 triangles in the given fig.  
 $\triangle ABC, \triangle ABD, \triangle ADC, \triangle AFC, \triangle FDG,$   
 $\triangle AFB, \triangle FDB, \triangle FBC, \triangle GBD, \triangle ADE,$   
 $\triangle GBE, \triangle FDG$  and  $\triangle DBE$

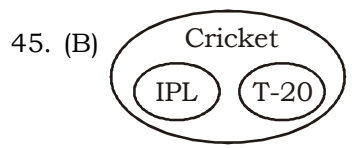

57. (C) Contour ploughing is the farming practice of ploughing across a slope following its elevation contour lines. The rows from slow water run-off during

- rainstorms to prevent soil erosion and allow the water time to settle into the soil.
61. (D) The Volga is the largest river in Europe in terms of length, discharge, and watershed. It flows through the western part of Russia and is widely viewed as the national river of Russia.
63. (D) At present, the IUCN Red List of Threatened Species (also known as the Red Data List) lists eight classes of organism under the group of threatened categories of critically endangered. The classes of organism for which the 'threatened' tag is applied are mammals, birds, reptiles, amphibians, fishes, insect, mollusc and plants.
65. (B) Satyameva Jayate (Truth Alone Triumphs) is a mantra from the ancient Indian scripture Mundaka Upanishad which is one of the earlier, primary (mukhya) Upanishad, a genre of Hindu scriptures commented upon by Shankara. It is associated with the Atharva Veda. Upon independence of India, it was adopted as the national motto of India. The origin of the motto is a well-known mantra 3.1.6 from the Mundaka Upanishad.
67. (D) If the mass of the body is  $m$ , the force of attraction of the earth, or the weight  $w$  of the body, is given by the Newton's law of gravitation as  $w = mg$ , with acceleration due to gravity  $g = \frac{GM}{R^2}$  where  $M$  and  $R$  are the mass and radius of the Earth respectively. Weight of the body is maximum at the centre of the earth and zero at the centre of the earth.
68. (C) A microcomputer is a small relatively inexpensive computer with microprocessor as its Central Processing Unit (CPU). It is most commonly associated with the first wave of all-in-one 8-bit home computers and small business microcomputer (such as the Apple II, Commodore 64, BBC Micro, and TRS 80).
70. (A) Pitch is a perceptual property that allows the ordering of sounds on frequency-related scale. Pitch may be quantified as a frequency - related scale. Pitch is not a purely objective physical property. It is a subjective psycho-acoustical attribute of sound. When the frequency is high, the wavelength of the sound is shorter.
71. (C) Rajasthan is a land-locked state which is bordered by Pakistan to the west, Gujarat to the south-west, Madhya Pradesh to the south-east, Uttar Pradesh and Haryana to the north-east and Punjab to the north.
73. (B) The Indian citizenship and nationality law and the constitution of India provide single citizenship for all of India. However, there is a form of Indian nationality, the holders of which are known as Overseas Citizens of India. Prime Minister, Atal Bihari Vajpayee, on January 10, 2003 announced a provision for dual citizenship for People of Indian Origin (PIO) living in certain countries. Dual citizenship was made available to PIOs of seven countries-the US, Canada, Australia, New Zealand, Singapore and Malaysia.
74. (C) All proteins contain Nitrogen. Precisely, they contain about 16 percent Nitrogen. The determination of protein requirement is based on Nitrogen balance, which include total Nitrogen in food and excreta.
79. (B) The 52<sup>nd</sup> Constitutional Amendment of 1985 amended articles 101, 102, 190 and 191; and inserted Schedules 10 to the Constitution of India. It dealt with the Anti Defection Law and provided disqualification of members from parliament and assembly in case of defection from one party to other.
80. (C) Services provided by housewives can be categorized as non-economic services and thus cannot be accounted in national income which is the sum total of all the goods and services produced in a country, in a particular period of time.
83. (C) The international Monetary Fund has headquarters in Washington, D.C., United States. It is an international organization that was created on July 22, 1944 at the Bretton Woods conference and came into existence on December 27, 1945 when 29 countries signed the Articles of Agreement.
84. (B) Dr. A.P.J. Abdul Kalam is the undisputed father of India's missile programme. He has breathed life into ballistic missiles like the Agni and Prithvi, which put China and Pakistan well under India's missile range. It is too exhausting to track Dr Abdul Kalam's achievements to date. In the 60s and 70s he was a trail blazer in

the space department. In the 80s he transformed the moribund Defence Research and Development Laboratory in Hyderabad into a highly motivated team. By the 90s Kalam emerged as the boon for Indian science and technology and was awarded the Bharat Ratna.

85. (C) Hot money is a term that is most commonly used in financial markets to refer to the flow of funds for capital) from (or capital) from one country to another in order to earn a short-term profit on interest rate differences and/or anticipated exchange rate shifts. These speculative capital flows are called "hot money" because they can move very quickly in and out markets, potentially leading to market instability.
88. (D) Lysosomes are known as digestive bag because it digest foreign material as well as worn out cell organelles. They contain powerful digestive enzymes which are capable of breaking down all organic materials.
89. (C) The decibel (DB) is a logarithmic unit that indicates the ratio of a physical quantity (usually power or intensity) relative to a specified or implied reference level. A ratio in decibels is ten times the logarithm to base 10 of the ratio of two power quantities.
94. (A) Rajendra Kumar Pachauri has been serving as the chairperson of the Intergovernmental Panel on Climate Change since 2002, who was awarded the Nobel Peace Prize in 2007 during his tenure. The IPCC shared the 2007 Nobel Peace Prize with former U.S. Vice President Al Gore, who had earlier criticised Pachauri when he was first elected in 2002.
99. (A) Biogas typically refers to a gas produced by breakdown of organic matter in the absence of oxygen. Organic waste such as dead plant and animal material, animal faeces and kitchen waste can be converted into a gaseous fuel called biogas. Biogas originates from biodegradable materials such as biomass, manure, sewage, municipal waste, green waste, plant material, and crops, Biogas comprises primarily methane (CH<sub>4</sub>) and carbon dioxide (CO<sub>2</sub>) and may have small amounts of hydrogen Sulphate (H<sub>2</sub>S), moisture and siloxanes.

100. (D) Shivsamudra is a small town in the Mandya District of the state of Karnataka. It is situated on the banks of the river Kaveri, which forms here the boundary to the Chamarajanagar District and the location of one of the first Hydro-electric power stations in Asia, which was set up in the year 1902.

107. (c)  $f = \frac{PN}{120}$

$$f = \frac{8 \times 1800}{120} = 120$$

$$f' = f + 60 = 120 + 60 = 180 \text{ Hz.}$$

113. (C)

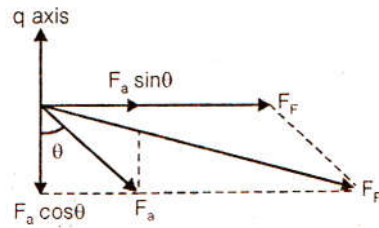

In this case the armature reaction is partially magnetising due to  $F_a \sin \theta$  component and partially cross magnetising due to  $F_a \cos \theta$  component

$$E = kn\phi N$$

$$V - I_a R_a = kn\phi N$$

$$\downarrow N = \frac{V - I_a R_a}{K_n \phi \uparrow}$$

So speed decreases

120. (B)

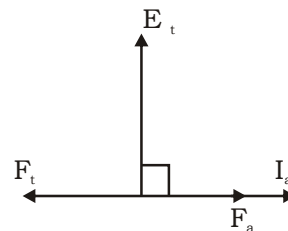

From above figure, we know that  $I_a$  lags  $E$  by  $[90^\circ]$ . So its armature reaction should be purely demagnetizing in nature.

122. (D) The angle between the axis of main field mmf and the axis of armature mmf will be  $= \Psi + 90^\circ$

$$\text{where } \Psi = \delta + \phi = 15^\circ + \cos^{-1} . 707 = 60^\circ$$

$$\therefore \text{Total angle} = 60^\circ + 90^\circ = 150^\circ$$

127. (B) ACSR is Aluminium conductor steel reinforced. In this the outer conductors made of aluminium.

132. (C) We require three over-current relays as phase-fault relays

133. (A)  $S.I.L. = \frac{(kv)^2}{Z_{c.in} \Omega} = \dots \text{in MW}$

134. (D) Main loss of energy is at condenser.

136. (B) Line reactance per Km = 0.726  
for 100 km. = 72.6

$$\therefore \text{static capacity} = \frac{V^2}{X} = \frac{(132)^2}{72.6} \text{ MW}$$

$$= 240 \text{ MW}$$

137. (D)  $V_s = V_r + I_r Z$   
 $= 300 + j.8 [500 \times 0.8 - 500 \times 0.6]$   
 $= 300 + j320 + 240 = 540 + j320$   
 p.f. =  $320/540 = 0.6 \text{ lag.}$

139. (C) Taking  $L/R = 1$ . then  $\cos \phi = \cos 45 = 0.707$

148. (A) At resonance the circuit will behave as pure resistive circuit.

150. (A) Converting  $\Delta$  connection ( $\Delta$ ) OBC into star connection

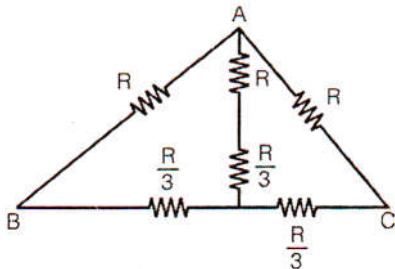

Now Reducing above network

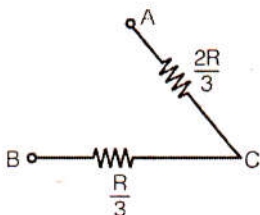
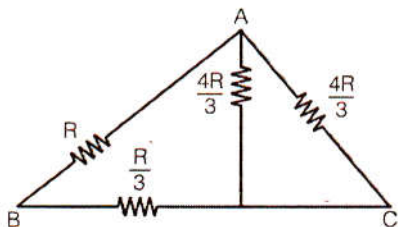

So  $R_{AB} = \frac{2R}{3} + \frac{R}{3}$   
 $R_{AB} = R$

151. (C)

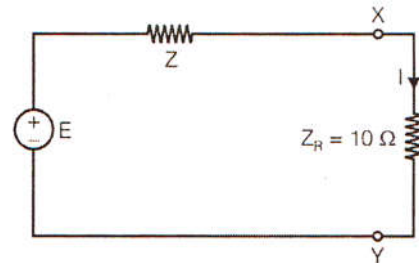

where  $E = \frac{E_1 Y_1 + E_2 E_2 + E_3 Y_3}{Y_1 + Y_2 + Y_3}$

$$= \frac{1 \times \frac{1}{1} + 2 \times \frac{1}{2} + 3 \times \frac{1}{3}}{\frac{1}{1} + \frac{1}{2} + \frac{1}{3}} = \frac{18}{11}$$

$$Z = \frac{6}{11} \Omega$$

$$\therefore I = \frac{E}{Z + Z_R} = \frac{9}{58} \text{ a}$$

152. (A)

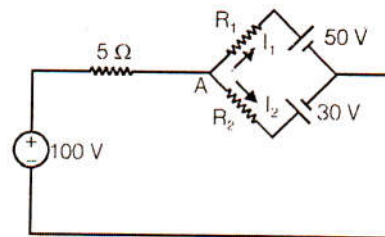

The current through 5Ω resistance is

$$I_5 = I_1 + I_2 = 1 + 5 = 6A$$

Voltage across 5Ω is  $V_5 = 5 \times 6 = 30 \text{ V}$

The voltage at node A is

$$V_A = 100 - 30 = 70$$

$$I_2 = \frac{V_A - 30}{R_2} = \frac{40}{R_2}$$

$$\therefore R_2 = \frac{40}{5} = 8 \Omega$$

$$\therefore I_1 = \frac{V_A - 50}{R_1} = \frac{20}{R_1}$$

$\therefore R_1 = 20 \Omega$

153. (B) When supply is conected

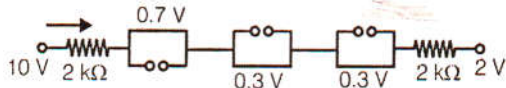

$$I = \frac{10 - 2 - 0.3 - 0.3 - 0.7}{(2+2) \times 10^3} = 1.675 \text{ A}$$

Note the Si diode across Ge in the third branch will never get the opportunity to turn On. So it maintains open circuit.

154. (B) Given equivalent circuit is Norton's circuit

$$V = 41 - 9$$

Put  $V = 0$        $I = I_N = \frac{9}{4} \text{ A}$

$$\therefore I_N = \frac{-9}{4}$$

and  $I_N = I_{SC}$  (whose direction is opp. to I)

Put  $I = 0$

$$R_{th} = \frac{|-9|}{9/4} = 4 \Omega$$

155. (D)  $P = \sqrt{3} V_{ph} \cdot I_{ph}$

$$V_{ph} = \frac{V_L}{\sqrt{3}} = \frac{400}{\sqrt{3}}$$

$$I_{ph} = \frac{V_{ph}}{R_{eq}} \text{ and } R_{eq} = 20 \Omega$$

$$I_{ph} = \frac{400}{20} = 20$$

$$P = \sqrt{3} \times \frac{400}{\sqrt{3}} \times 20 = 8 \text{ KW}$$

156. (D)  $B.W = \frac{R}{L}$

$$\therefore \text{ for } R \rightarrow 2R \text{ and } L \rightarrow \frac{L}{2}$$

$$\therefore B.W \text{ becomes } = \frac{2R}{L/2} = 4 \frac{R}{L}$$

157. (C)

Taking KCL at  $V_A$

$$\frac{V_A - 5}{2} + \frac{V_A}{2} + \frac{V_A - V_B}{6} = 0$$

$$\therefore 3V_A - 15 + 3V_A + V_A - V_B = 0$$

$$7V_A - V_B = 15$$

and at  $V_B$

$$\frac{V_B}{2} + \frac{V_B - V_A}{6} + (-2) = 0$$

$$3V_B + V_B - V_A - 12 = 0$$

$$4V_B - V_A = 12$$

Solving  $V_A$  and  $V_B$  we get

$$V_A = \frac{8}{3} = \frac{24}{9}$$

$$V_B = \frac{11}{3} = \frac{33}{9}$$

158. (C) Writing KCL at supernode

$$V_1 + V = 3$$

$$V - V_1 = 3$$

from (1) and (2)  $2V = 6 \Rightarrow V = 3 \text{ volt}$

159. (d)

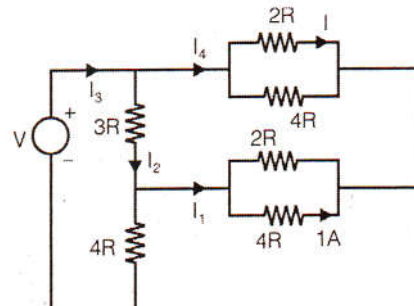

Finding  $I_1$  from current divider

$$I_1 = \left( \frac{1}{2+4} \right) \cdot I_4$$

$$I_1 = 3A$$

Now finding  $I_2$  from current divider

$$3 = \left( \frac{4}{4 + \frac{4}{3}} \right) I_2 \quad \left( 2 \parallel 4 = \frac{4}{3} \right)$$

$$I_2 = 4A$$

Now finding  $I_3$  from current divider

$$4 = \left( \frac{4}{\frac{3}{4} + 4} \right) I_3 \quad \left[ \begin{array}{l} (2 \parallel 4) \parallel 4 = 1 \\ 1 + 3 = 4 \end{array} \right]$$

$$I_3 = 16$$

$$I_3 = I_2 + I_4$$

$$16 = 4 + I_4$$

$$I_4 = 12$$

Again using current divider

$$I = \left( \frac{4}{4+2} \right) 12$$

$$I = 8 \text{ A}$$

$$170. (A) \quad \tan \phi = \sqrt{3} \left( \frac{P_1 - P_2}{P_1 + P_2} \right)$$

$$P_1 = 3 \text{ kW}$$

$$P_2 = -1 \text{ kW}$$

$$\tan \phi = \sqrt{3} \left( \frac{4}{2} \right)$$

$$\tan \phi = 2\sqrt{3}$$

$$\phi = 73.89$$

$$\text{Power factor} = \cos \phi = 0.277$$

171. (C) Due to reverse bias of collector junction effective base width is less than metallurgical base width and this is called Early effect.

Note: Also known as base width modulation as effective base width varies

with biasing.

173. (C) Electrical field is always maximum at the junction.

$$179. (C) \quad \text{For JFET } I_D = I_{DSS} \left( 1 - \frac{V_{GS}}{V_P} \right)^2$$

$$\Rightarrow 0 = \left( 1 - \frac{V_{GS}}{V_P} \right)^2$$

$$\Rightarrow V_{GS} = V_P$$

$$\therefore V_{GS} = 5 \text{ Volts}$$

$$180. (C) \quad \rho_i = \frac{1}{\sigma_i}$$

$$= \frac{1}{en_i(\mu_n + \mu_p)}$$

$$= 2.35 \times 10^5 \Omega \text{ cm}$$

181. (B) The cut in voltage for diode  $D_1$  is lower than that of  $D_2$ . So diode  $D_1$  will be on and whole current passes through short ckt path of  $D_1$ .

$$\text{and } I_1 = \frac{100 - 0.2}{10 \times 10^3} = 10 \text{ mA}$$

$$\text{and } I_1 = 0$$

$$184. (B) \quad I_C = \frac{V_{CC} - V_{CE \text{ sat}}}{R_C} = \frac{10 - 0.3}{1K}$$

$$I_C = 9.7 \text{ mA}$$

**For all latest updates about Vacancies, Mock Test Solutions &  
Study Material, please like our facebook page  
"KD CAMPUS TECHNICAL"**