



KD Campus Pvt. Ltd

2007, OUTRAM LINES, 1ST FLOOR, OPPOSITE MUKHERJEE NAGAR POLICE STATION, DELHI-110009

Answer-key & Solution

SSC JE (Electrical)
MOCK -(129)
Date:- 30.12.2017

1. B	26. A	51. C	76. D	101. B	126. D	151. B	176. D
2. D	27. D	52. C	77. B	102. B	127. A	152. B	177. C
3. C	28. D	53. A	78. D	103. B	128. B	153. A	178. A
4. C	29. C	54. A	79. C	104. B	129. A	154. C	179. A
5. D	30. B	55. B	80. C	105. B	130. D	155. A	180. B
6. A	31. B	56. B	81. C	106. B	131. D	156. B	181. A
7. D	32. C	57. D	82. C	107. D	132. D	157. A	182. D
8. B	33. D	58. D	83. B	108. B	133. B	158. C	183. C
9. A	34. D	59. A	84. D	109. B	134. C	159. B	184. B
10. D	35. C	60. B	85. C	110. A	135. C	160. D	185. D
11. B	36. A	61. B	86. D	111. C	136. D	161. B	186. C
12. B	37. C	62. B	87. C	112. A	137. C	162. B	187. B
13. C	38. D	63. C	88. C	113. C	138. C	163. C	188. B
14. D	39. D	64. A	89. A	114. A	139. D	164. C	189. C
15. C	40. B	65. B	90. B	115. D	140. B	165. C	190. B
16. B	41. B	66. C	91. B	116. A	141. C	166. D	191. A
17. C	42. A	67. C	92. B	117. A	142. B	167. D	192. A
18. D	43. C	68. D	93. D	118. D	143. B	168. C	193. D
19. B	44. B	69. C	94. D	119. B	144. B	169. D	194. B
20. C	45. A	70. B	95. C	120. A	145. C	170. B	195. B
21. C	46. B	71. B	96. D	121. A	146. C	171. A	196. C
22. D	47. C	72. B	97. C	122. A	147. D	172. B	197. D
23. B	48. D	73. D	98. C	123. A	148. B	173. D	198. A
24. C	49. C	74. B	99. C	124. C	149. C	174. C	199. C
25. C	50. C	75. C	100. B	125. C	150. D	175. C	200. D

Note : If your opinion differ regarding any answer, please message the mock test and Question number to 9821756838

Note : If you face any problem regarding result or marks scored, please contact : 9313111777

SOLUTION SSC JE (Electrical) MOCK TEST no. 129

- 1. (B) Elated is the opposite of despondent. Enlightened is the opposite of ignorant.
- 2. (D) A group of lions is called a pride. A group of fish is called a shoal.
- 3. (C) An oar puts a rowboat into motion. A foot puts a skateboard into motion.
- 4. (C) As magnet has poles, similarly battery has terminals.

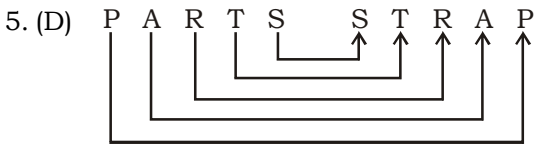

Similarly,

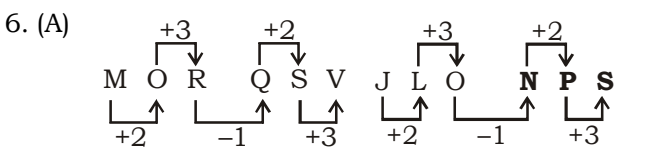
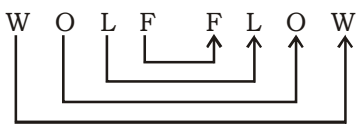

- 7. (D) As 'Conduction' is the property found in 'Metal', in the same way 'Insulation' is the property found in 'Plastic'.
- 8. (B) Walk, skip, and run represent a continuum of movement. Skipping is faster than walking, running is faster than skipping.
Below the line, the continuum is about throwing: Pitch is faster than toss; hurl is faster than pitch.

9. (A) $7 + 6 = 13$ & $7 - 6 = 1$, $13 - 1 = 12$
 $9 + 4 = 13$ & $9 - 4 = 5$, $13 - 5 = 8$

10. (D) $12 : 1584 :: 8 : 448$

$$\begin{matrix} \downarrow & & \downarrow \\ 12^2 \times (12 - 1) & & 8^2 \times (8 - 1) \\ = 144 \times 11 & & = 64 \times 7 \end{matrix}$$

- 11. (B) Dodge, duck, and avoid are all synonyms which means evade. The word Flee means to run away.
- 12. (B) A branch, leaf, and root are all parts of a tree. The dirt underneath is not a part of the tree.
- 13. (C) Heading, body, and closing are all parts of a letter.
- 14. (D) The first three choices are all synonyms.
- 15. (C) The wing, fin, and rudder are all parts of an airplane.

- 16. (B) Except (73), all are the sum of squares of continuous natural numbers.

$$\begin{aligned} \text{Sqr}(3) + \text{Sqr}(4) + \text{Sqr}(5) &= 9 + 16 + 25 = 50 \\ \text{Sqr}(5) + \text{Sqr}(6) + \text{Sqr}(7) &= 25 + 36 + 49 = 110 \\ \text{Sqr}(6) + \text{Sqr}(7) + \text{Sqr}(8) &= 36 + 49 + 64 = 149 \\ \text{Sqr}(4) + \text{Sqr}(5) + \text{Sqr}(6) &= 16 + 25 + 36 \neq 73 \end{aligned}$$

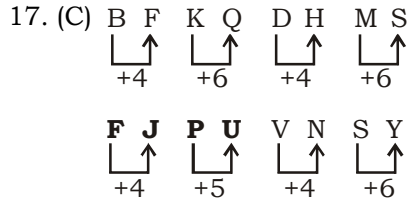

- 18. (D) Except X, the position of the letters of alphabet is in the form of multiple of 5. Position (Y) = 25, Position (J) = 10, Position (T) = 20, Position (X) = 24,

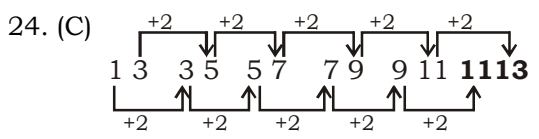
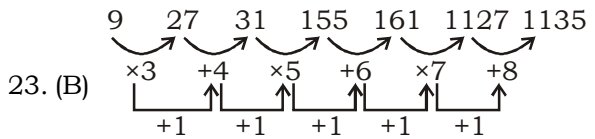
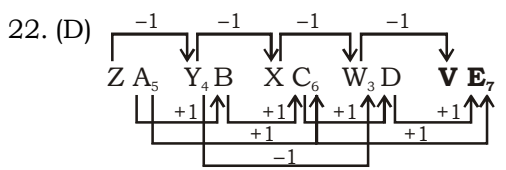
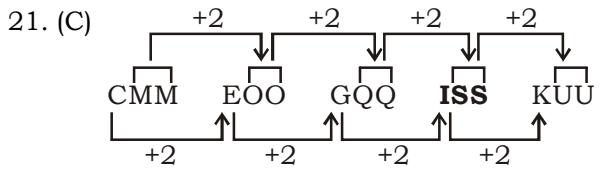
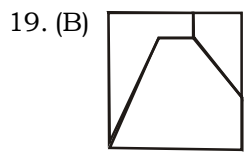

- 25. (C) Blackboard is in Class and Class is in the School.
- 26. (A) A is the mother of B, B is the brother of C and C is the daughter of D. Hence, D is the father.

A (Parents) **D**
| |
| |
B is the Brother of **C**

Here, the one which are bold are females (A, C) and not bold are males (B, D).

27. (D) From *wilkospadi*, we can determine that *wilko* means bicycle and *spadi* means race. So, the first part of the word that means race car should begin with *spadi*. As the word *wilko* means bicycle. Therefore, the answer must be choice d, *spadivolo*.

28. (D) According to the statement, 80% of the total runs were made by spinners. So, I does not follow. Nothing about the opening batsmen is mentioned in the statement. So, II also does not follow.

29. (C) The correct order is :
Advertisement Application Interview
(5) → (6) → (2)
Selection Appointment Probation
(3) → (4) → (1)

30. (B)  1. ✗ 2. ✓

31. (B) 'The only daughter of the father of X's mother' means mother of X. Hence X is the son of the lady in the photograph.

32. (C) $(4 \times 7) \div 4 = 7$
and $(6 \times 2) \div 3 = 4$
Therefore, $(6 \times 2) \div 2 = 6$.

33. (D) $(5 \times 6) + 2 = 32$
 $(7 \times 6) + 2 = 44$
 $(7 \times 5) + 2 = 37$

34. (D) $(1)^2 + (5)^2 + (4)^2 + (3)^2 = 51 \Rightarrow 51 \times 10 = 510$
and $(3)^2 + (4)^2 + (6)^2 + (2)^2 = 65 \Rightarrow 65 \times 10 = 650$
Similarly,
 $(0)^2 + (1)^2 + (2)^2 + (8)^2 = 69 \Rightarrow 69 \times 10 = 690$.

35. (C) For first triangle,
 $10 - 4 = 6$
 $18 - 10 = 8$
 $18 - 4 = 14$
For second triangle,
 $14 - 8 = 6$
 $22 - 14 = 8$
 $22 - 8 = 14$
For third triangle,
 $11 - 5 = 6$
 $15 - 11 = 4$
 $15 - 5 = 10$.

36. (A)

Top Face			
Bottom Face			

[Take '∴' (3) points as common and move in a clockwise direction.]

We can observe that "∴" (4) points is missing. So, four (4) points will be top when three (3) points are at bottom.

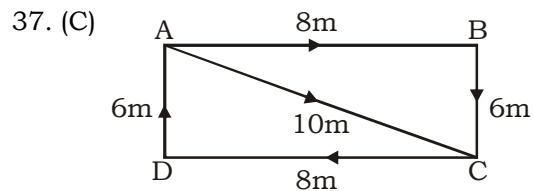

$$\begin{aligned} \text{Required distance} &= 8 + 6 + 8 + 6 + \sqrt{8^2 + 6^2} \\ &= 28 + \sqrt{100} \\ &= 28 + 10 = 38 \text{ m} \end{aligned}$$

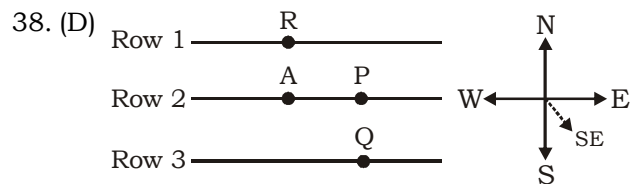

Q is in South-East of R.

39. (D) Let x and y be the number of deer and peacocks in the Zoo respectively.

Then,
 $x + y = 80$... (i) and
 $4x + 2y = 200$ or $2x + y = 100$... (ii)
Solving (i) and (ii), we get) $x = 20$, $y = 60$.
So, the number of peacocks in a Zoo is 60.

40. (B) Let Tanya's share = ₹ x

Then, Veena's share = ₹ $\left(\frac{x}{2}\right)$

Amit's share = ₹ $\left(\frac{2}{3} \times \frac{x}{2}\right) = ₹ \left(\frac{x}{3}\right)$

Total bill = ₹ $\left(x + \frac{x}{2} + \frac{x}{3}\right) = ₹ \left(\frac{11x}{6}\right)$

∴ Required fraction = $\left(\frac{x}{2} \times \frac{6}{11x}\right) = \frac{3}{11}$

41. (B) When Rahul was born, his brother's age = 6 yrs
His father's age = $(6 + 32)$ years = 38 yrs
His mother's age = $(38 - 3)$ years = 35 yrs
His sister's age = $(35 - 25)$ years = 10 yrs.

42. (A)

43. (C)

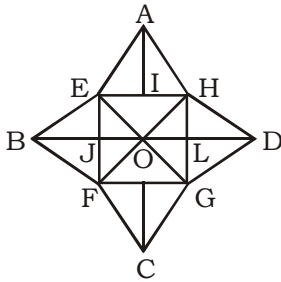

The simplest triangles are AEI, AIH, BEJ, BKF, CFK, CKG, DGL, DLH, EOJ, FOJ, FOG, LOG, HOL and HOE i.e. 14 in number.

Triangles composed of two components each are EAH, FBE, BEO, EOF, BFO, FCG, GDH, HOD, HOG and GOD i.e. 10 in number.

Triangles composed of three components each are EFH, EHG, FGH and EFG i.e. 4 in number.

Thus, there are $14 + 10 + 4 = 28$ triangles in the given figure.

44. (B)

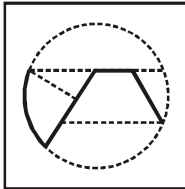

45. (A)

46. (B) 1, 5, 7 have two similar elements, one inside the other.

2, 4, 8 have one element placed inside a different element.

3, 6, 9 have two similar elements, one inside the other and the area between the two elements is shaded.

47. (C)

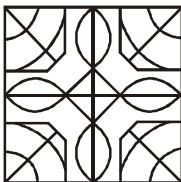

48. (D)

•••	•	••	Top face
••	••	•••	Opposite face

When the given figure is folded to form a cube, then the face bearing six dots will lie opposite the face bearing three dots.

49. (C) All other figures except (C) contain a geometrical figure along with its mirror image.

50. (C)

51. (C) Halebidu (literally "ruined city"), also known as Dwarasamudra, was the regal capital of the Hoysala Empire in the 12th century. It is home to one of the best examples of Hoysala architecture in the ornate Hoysaleswara and Kedarewara temples. This name 'Halebidu' was given because this city was ruined two times by Bahmani Sultanate.

52. (C) The Vice President of India is the second highest office in India, after the President. The Vice President is elected indirectly by an electoral college consisting members of both houses of the Presidency upon the death, resignation, impeachment or other situations leading to the vacancy in the Office of President.

54. (A) The preamble to the Constitution of India is a brief introductory statement that set out the guiding purpose and principles of the document. As originally enacted the preamble described the state as a 'sovereign democratic republic'. In 1976 the Forty second Amendment changed this to read 'sovereign socialist secular democratic republic'.

55. (B) The Tummalapalle Mine is a uranium mine in Tumalapalli village located in Kadapa of the Indian state of Andhra Pradesh. Tummalapalle in Andhra Pradesh could have one of the largest uranium reserves in the world. Recent studies have indicated that it could have a reserve of 1.5 lakh tonnes of the scarce material.

56. (B) The Indo-Greek kings were the first to issue gold coins in India and their coins were special in the sense that each king had his own distinctive coins by which he could be definitely identified. The names of at least thirty Bactrian kings are known with the help of numerous coins, and they help in the reconstruction of the history of the kings. The coins carry legends in Greek and also in Kharosthi and Brahmi.

57. (D) Laterite soils are found on the highland areas of plateau i.e. Karnataka, Kerala, Tamil Nadu and also in some hilly regions of Assam, Rajmahal hills and Chhotanagpur plateau. These soils are poor in lime but rich in iron. So these are suitable for plantation of crops like tea, rubber, coffee etc.

62. (B) Seller's market is a market which has more buyers than sellers. High prices result from this excess of demand over supply. The opposite of the seller's market is the buyer's market, where supply greatly exceeds demand.

63. (C) Balance of payments (BoP) accounts are an accounting record of all monetary transactions between a country and the rest of the world. These transactions include payment for the country's exports and imports of goods, services, financial capital and financial transfers. The BoP accounts summarize international transactions for a specific period, usually a year and are prepared in a single currency, typically the domestic currency for the country concerned.
64. (A) South-South Cooperation is a term historically used by policymakers and academics to describe the exchange of resources, technology and knowledge between developing countries, also known as countries of the global South.
66. (C) The Lotus Temple, located in New Delhi (India) is a Bahai House of Worship completed in 1986. Notable for its flowerlike shape, it serves as the Mother Temple of the Indian subcontinent and has become a prominent attraction in the city.
68. (D) Life Divine is the philosophical magnum opus of Sri Aurobindo. It combines a synthesis of western insights. The Life Divine covers topics such as the human aspiration, the emergence of life in the cosmos, the evolution of matter to spirit in the universe, the division and dualities inherent in human consciousness, the man's ignorance through an evolution of consciousness, and the spiritual destiny of life on earth.
71. (B) CSIR- Central Food Technological Research Institute, abbreviated to CSIR-CFTRI which is one of the 40 national research laboratories in India was set up under the aegis of the Council of Scientific and Industrial Research (CSIR). It is located in Mysore (Karnataka) and was opened in 1950.
72. (B) Disinvestment is a process where Government sells its equity holding to private sectors. In other ways it is a privatization process where private parties are given shareholding in Government undertakings either wholly or partially.
73. (D) A modem (modulator-demodulator) is a device that modulates an analog carrier signal to encode digital information and also demodulates such a carrier signal to decode the transmitted information. The goal is to produce a signal that can be transmitted easily and decoded to reproduce the original digital data.
74. (B) Bank of India is an Indian state-owned commercial bank with headquarters in Mumbai (Maharashtra). It has been government-owned since nationalization in 1969. It is India's 4th largest PSU bank after State Bank of India, Punjab National Bank and Bank of Baroda.
76. (D) The All India Depressed Classes Federation was formed at the Conference of the Depressed Classes at Nagpur on August 8, 1930. This organization was the brainchild of Dr. B. R. Ambedkar who presided over this conference.
77. (B) The Nobel Peace Prize is one of the five Nobel Prizes bequeathed by the Swedish industrialist, inventor and armaments manufacturer Alfred Nobel, along with the prizes in Chemistry, Physics, Physiology or Medicine and Literature. Since 1901, it has been awarded annually (with some exceptions) to those who have done the most or the best work for fraternity between nations, for the abolition or reduction of standing armies and for the holding and promotion of peace. Nobel Prize is not given in Mathematics.
78. (D) The Hypertext Transfer Protocol (HTTP) is an application protocol for distributed, collaborative, hypermedia information systems. HTTP is the foundation of data communication for the World Wide Web. HTTP is the protocol to exchange or transfer hypertext.
81. (C) In this case the given equation shows that the velocity is linear with time and therefore the particle is moving with constant acceleration because for a particle to acquire constant acceleration the graph of the velocity time graph should be linear with the time functions.
82. (C) Spirit is highly volatile. So when it is exposed, it evaporates rapidly to the air and if released into the environment it produces a cool effect.
84. (D) Mass number = protons or mass of electron (atomic number) + neutrons. So it is mostly greater than the atomic number. At best, it can be equal to the atomic number.
85. (C) Insulin is a peptide hormone produced by beta cells of the pancreas, and is used for regulating carbohydrate and fat metabolism in the body. Insulin causes cells in the liver, skeletal muscles, and fat tissue to take up glucose from the blood. In the liver and skeletal muscles, glucose is stored as glycogen, and in adipocytes it is stored as triglycerides.

88. (C) The total energy of a revolving electron in any orbit is the sum of its kinetic and potential energies. Energy of an electron at infinite distance from the nucleus is zero. As an electron approaches the nucleus, the electron attraction increases and the energy of electron decreases and thus becomes negative. Thus, it can never be positive.
92. (B) Indigo is a dye different from any other. It does not require any mordant. Rather it is dyed through a living fermentation process. The process 'reduces' the Indigo, changing it from blue to yellow. In this state, it is a bright green. Slowly the air changes it to the beautiful deep and rich blue of Indigo.
93. (D) Progesterone is one of the hormones in our body that stimulates and regulates various functions. Progesterone plays a role in maintaining pregnancy. The hormone is produced in the ovaries (the placenta (when a woman gets pregnant) and the adrenal glands). It helps in preparing the body for conception and pregnancy and regulates the monthly menstrual cycle. It also plays an important role in sexual desire.
94. (D) A rectifier is an electrical device that converts alternating current (AC) which periodically reverses direct current (DC) which flows in only one direction. The process is known as rectification. Physically, rectifiers take a number of forms including vacuum tube diodes and mercury valves, solid-state diodes, silicon-controlled rectifiers and other silicon-diode based semiconductor switches.
95. (C) Landfill is the most common and the oldest method for waste disposal management. Incineration is the second largest method for waste disposal management in most of the countries around the world.
96. (D) Butane is highly flammable, colourless, easily liquefied gases. When blended with propane and other hydrocarbons. It is referred to commercially as LPG for liquefied petroleum gas.
97. (C) Zirconium is a lustrous, grey-white, strong transition metal that resembles Titanium. Zirconium is mainly used as a refractory and opacifier, although it is used in small amounts as an alloying agent for its strong resistance to corrosion.

99. (C) A basic microscope is made up of two converging lenses. The first lens creates a real image which serves as the object for the second lens, and the image created by the second lens is the one a viewer sees. The final image is magnified, virtual and is inverted compared to the original object.

101. (B)

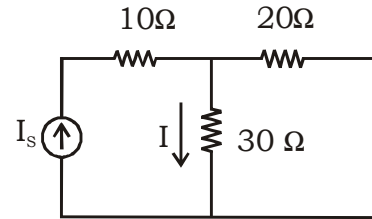

$$I = 3 \text{ A (Given)}$$

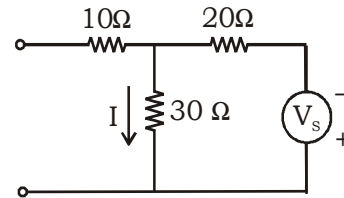

$$I = -4 \text{ A}$$

$$\text{So, Net current } I = 3 - 4 = -1 \text{ A}$$

102. (B)

$$R_{th} = \frac{V_{o.c}}{I_{sc}} = \frac{20}{4} = 5 \Omega$$

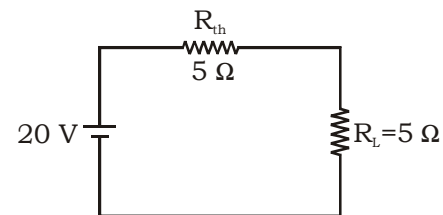

$$I = \frac{20}{5+5} = 2 \text{ A}$$

103. (B)

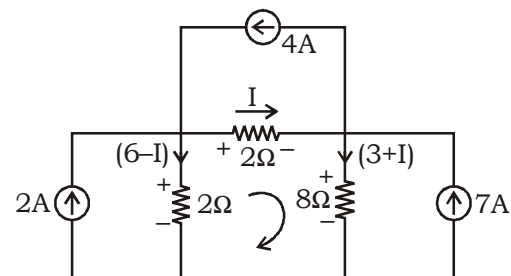

Apply KVL :

$$-2I - 8(3+I) + 2(6-I) = 0$$

$$-2I - 24 - 8I + 12 - 2I = 0$$

$$-12I = 12$$

$$I = -1 \text{ A}$$

104. (B)

For maximum power transfer $R_L = R_{th}$

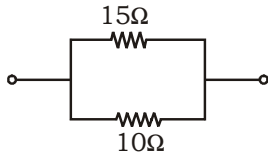
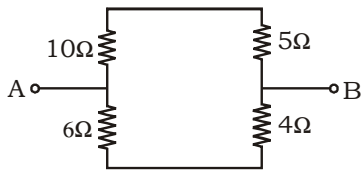

$$R_{th} = R_L = \frac{150}{25} = 6 \Omega$$

105. (B)

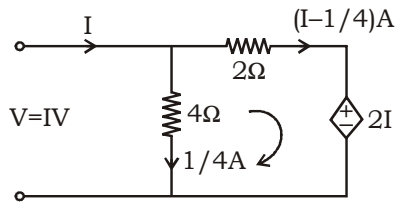

$$\begin{aligned} -2(I - 1/4) - 2I + 4 \times 1/4 &= 0 \\ -2I + 1/2 - 2I + 1 &= 0 \\ 4I &= 3/2 \\ I &= 3/8 \text{ A} \end{aligned}$$

$$R_{eq} = \frac{V}{I} = \frac{1}{3/8} = 8/3 \Omega$$

110. (A)

$$|e| = N \frac{d\phi}{dt} = 100 \frac{d(t^3 - 2t)}{dt} \times 10^{-3}$$

$$\begin{aligned} |e| &= 100 (3t^2 - 2) \times 10^{-3} \\ &= 100 (12 - 2) \times 10^{-3} = 1 \text{ V} \end{aligned}$$

111. (C)

$$|e| = L \frac{di}{dt} = 2 \times 10 = 20 \text{ V}$$

117. (A)

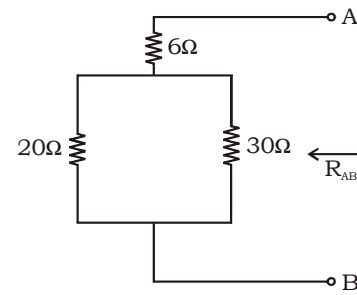
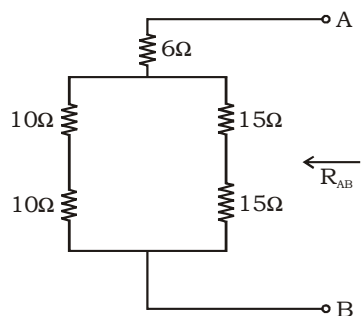

$$R_{AB} = 18 \Omega$$

118. (D)

$$Y_{eq} = \frac{1}{3 + j4} + \frac{1}{5 - j10}$$

$$Y_{eq} = \frac{5 - j10 + 3 + j4}{15 + 40 - j30 + j20} = \frac{8 - j16}{55 - j10}$$

$$Z_{eq} = \frac{1}{Y_{eq}} = \frac{55 - j10}{8 - j6} \times \frac{8 + j6}{8 + j6}$$

$$= \frac{55 \times 8 + 60 + j55 \times 6 - j80}{64 + 36}$$

$$Z_{eq} = 5 + j2.5$$

$$\begin{aligned} Y_{eq} = G + jB &= \frac{1}{5 + j2.5} \times \frac{5 - j2.5}{5 - j2.5} \\ &= 0.16 - j0.08 \end{aligned}$$

Susceptance (B) = 0.08 \cup (Siemens)

119. (B)

$$G = \frac{R}{\omega L} = \frac{R}{\frac{1}{\sqrt{LC}} \times L} = R \sqrt{\frac{C}{L}}$$

or

$$Q = \omega CR = \frac{1}{\sqrt{LC}} CR = R \sqrt{\frac{C}{L}}$$

121. (A)

$$Z = 4 + j(12 - 9) = 4 + j3$$

$$|Z| = \sqrt{(4)^2 + (3)^2} = 5$$

$$I = \frac{2000}{5} = 40$$

$$P = I^2 R = 40 \times 40 \times 4 \Rightarrow 6400 \text{ W}$$

122. (A)

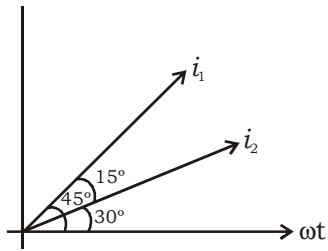

$$\phi = 45^\circ - 30^\circ = 15^\circ$$

124. (C)

$$V_s = V_m \sin \omega t$$

$$N_s = V_{RMS} \cdot \sqrt{2} \sin 2\pi f t$$

$$= 230\sqrt{2} \sin(2 \times 3.1416 \times 50) t$$

$$V_s = 325 \sin 314.16 t$$

127. (A)

$$10 \times k^2 = 6250$$

$$k^2 = 625$$

$$k = 25$$

128. (B)

$$N_s = \frac{120 \times f}{P} = \frac{120 \times 50}{20} = 300 \text{ rpm}$$

130. (D)

$$0.04 = \frac{1500 - N_r}{1500}$$

$$N_r = 1500 - 1500 \times 0.04 = 1440 \text{ rpm}$$

136. (D)

$$N_s = \frac{120 f}{P} = \frac{120 \times 50}{4} = 1500 \text{ rpm}$$

$$\text{So, Slip speed} = N_s - N_r = 60 \text{ rpm.}$$

138. (C)

$$\frac{Y_{\text{Phase}}}{\Delta_{\text{Phase}}} = K$$

$$\frac{Y_{\text{Line}}}{\Delta_{\text{Line}}} = \frac{\sqrt{3} Y_{\text{Phase}}}{\Delta_{\text{Phase}}} = \sqrt{3} K$$

142. (B)

$$\begin{aligned} \text{In generator, } V_t &= E - I_a R_a \\ &= 230 - 0.1 \times 200 \\ &= 210 \text{ V} \end{aligned}$$

145. (C)

Reflection coefficient,

$$= \frac{VSWR - 1}{VSWR + 1} = \frac{2 - 1}{2 + 1} = \frac{1}{3}$$

147. (D)

$$SWR = \left| \frac{R_L}{Z} \right| = \left| \frac{300}{75} \right| = 4$$

162. (B)

Diversity Factor,

$$= \frac{\Sigma \text{ Individual maximum Demand}}{P_{\text{max}}}$$

$$\text{Load Factor} = \frac{P_{\text{avg}}}{P_{\text{max}}}$$

$$\text{Both (D.F. \& L.F.)} \uparrow \propto \frac{1}{P_{\text{max}} \downarrow}$$

P_{max} decide the capacity of Plant.

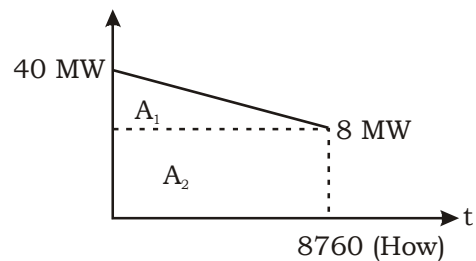

(i) If P_{max} is required more plant capacity will be more and cost increases.

(ii) If P_{max} is low so Capital cost Reduces due to capacity required reduces.

164. (C)

From Load Duration Curve,

$$\begin{aligned} P_{\text{avg}} &= \frac{\text{Area under the graph}}{\text{total time}} \\ &= \frac{A_1 + A_2}{8760} \end{aligned}$$

$$\text{Load factor} = \frac{P_{\text{avg}}}{P_{\text{max}}} = \frac{E_{\text{avg}}}{E_{\text{max}}}$$

$$\text{Load factor} = \frac{\frac{1}{2} \times 32 \times 8760 + 8 \times 8760}{40 \times 8760}$$

$$\text{Load factor} = \frac{16 + 8}{40} = \frac{24}{40} = 0.6$$

% Load factor = 60%.

168. (C)

Maximum value of unknown resistance =

$$\frac{(1000 + 100 + 10 + 1) \times 1000}{100}$$

$$= 11110 \Omega$$

Minimum value of unknown resistance =

$$\frac{1 \times 1000}{100}$$

$$= 10 \Omega$$

171. (A)

Current passing from voltmeter,

$$I_v = \frac{200}{2000} = 0.1 \text{ Amp.}$$

Current flowing from unknown resistance,

$I_R =$

ammeter reading - voltmeter current

$$= 2 - 0.1 = 1.9 \text{ Amp}$$

Unknown resistance,

$$R = \frac{\text{Voltmeter Reading}}{\text{Current through unknown resistance}}$$

$$= \frac{200}{1.9} = 105.3 \Omega$$

178. (A)

$$\text{Full scale current, } I_{FSD} = \frac{0.5}{10} = 0.05 = 50 \text{ mA}$$

Amp.

For extending the range of meter a shunt resistance will be added to the arrangement.

$$R_{sh} = \frac{R_m}{m - 1}$$

$$= \frac{R_m}{\left(\frac{I}{I_{FSD}} - 1\right)} = \frac{10}{\left(\frac{100}{50 \times 10^{-3}} - 1\right)}$$

$$R_{sh} = 0.005 \Omega$$

179. (A)

Multiplying factor (m) = 8

Circuit current (I) = 200 mA

Meter current,

$$\therefore m = \frac{I}{I_m}$$

$$I_m = \frac{I}{m} = \frac{200}{8} \text{ mA} \\ = 25 \text{ mA}$$