



KD Campus Pvt. Ltd

PLOT NO.2, SSI INDUSTRIAL AREA, G.T. KARNAL ROAD, JAHANGIRPURI, DELHI-110033

Answer-key & Solution

SSC JE (Electrical)
MOCK - (145)
Date:- 19.08.2018

1. C	26. B	51. A	76. B	101. C	126. C	151. C	176. C
2. B	27. B	52. C	77. D	102. B	127. B	152. C	177. D
3. B	28. A	53. B	78. B	103. D	128. A	153. B	178. D
4. C	29. D	54. A	79. B	104. C	129. D	154. A	179. D
5. A	30. C	55. B	80. D	105. B	130. A	155. A	180. A
6. C	31. C	56. C	81. B	106. B	131. A	156. D	181. A
7. B	32. D	57. D	82. A	107. B	132. A	157. D	182. C
8. D	33. A	58. A	83. A	108. A	133. C	158. D	183. C
9. A	34. C	59. C	84. C	109. A	134. B	159. B	184. C
10. C	35. A	60. B	85. B	110. B	135. A	160. B	185. A
11. A	36. C	61. C	86. A	111. A	136. B	161. A	186. D
12. A	37. A	62. C	87. A	112. B	137. C	162. C	187. D
13. A	38. D	63. C	88. B	113. B	138. B	163. A	188. B
14. B	39. B	64. C	89. D	114. A	139. A	164. D	189. C
15. B	40. B	65. B	90. D	115. D	140. C	165. A	190. A
16. C	41. B	66. C	91. B	116. C	141. B	166. B	191. A
17. B	42. B	67. A	92. C	117. C	142. A	167. B	192. D
18. B	43. A	68. A	93. C	118. C	143. D	168. C	193. C
19. C	44. A	69. B	94. B	119. D	144. A	169. A	194. D
20. C	45. C	70. A	95. B	120. D	145. B	170. A	195. A
21. C	46. B	71. B	96. A	121. B	146. C	171. A	196. A
22. C	47. B	72. D	97. C	122. C	147. C	172. B	197. C
23. A	48. B	73. C	98. C	123. A	148. B	173. C	198. A
24. A	49. B	74. C	99. D	124. A	149. D	174. B	199. C
25. B	50. C	75. B	100.D	125. A	150. A	175. A	200. A

Note : If your opinion differ regarding any answer, please message the mock test and Question number to 9560620353

Note : If you face any problem regarding result or marks scored, please contact : 9313111777

SOLUTION SSC JE (Electrical) MOCK TEST NO. 145

1. (C) As, Pneumonia is caused by Virus.
Similarly, Amoebiasis is caused by Protozoa.

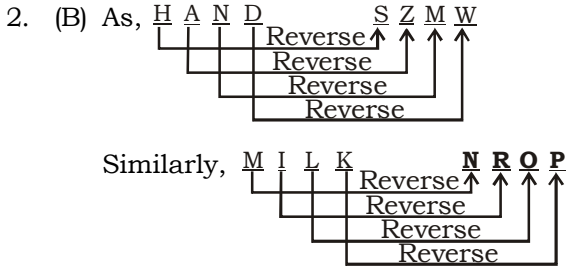

3. (B) As, $18^2 - (1+8) = 315$
Similarly, $16^2 - (1+6) = 249$
4. (C) Except Break, others are feelings.
5. (A) Except KLPD, others have atleast 1 Vowel.
6. (C) $57 - 69 \Rightarrow 69 - 57 = 12$
 $47 - 59 \Rightarrow 59 - 47 = 12$
 $71 - 84 \Rightarrow 84 - 71 = 13$
 $91 - 103 \Rightarrow 103 - 91 = 12$
7. (B) Abstemious \rightarrow Anonymous \rightarrow Solution \rightarrow Syllable \rightarrow Synonymous
8. (D) Let age of C = x years
age of B = 2x years
and, age of A = (2x + 2) years
Now, $(2x + 2) + 2x + x = 27$
 $\Rightarrow 5x = 25$
 $\Rightarrow x = 5$
So, age of B = 2x = 10 years

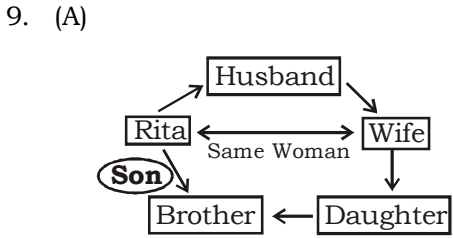

10. (C) ORANGE
11. (A) $\begin{matrix} 7 & , & 9 & , & 21 & , & 67 & , & 273 \\ \uparrow & & \uparrow & & \uparrow & & \uparrow & & \uparrow \\ \times 1+2 & & \times 2+3 & & \times 3+4 & & \times 4+5 & & \end{matrix}$
12. (A) $3+8+2=13$
 $8+13+3=24$
 $13+24+4=41$
 $24+41+5=70$

13. (A) The given series are sequence of prime numbers.

14. (B) Pattern is +1, +1+2, +1+2+3 and so on.
 \therefore Missing number = $15 + (1+2+3+4) = 25$

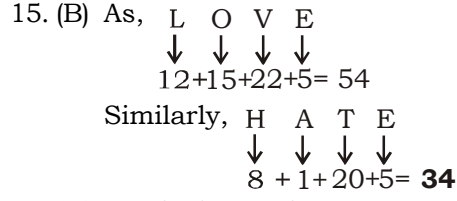

16. (C) $3 \times 5 \times 7 = 105$
 $5 \times 7 \times 9 = 315$
 $7 \times 9 \times 11 = 693$
17. (B) $\frac{8 \times 5}{2} = 20$ $\frac{9 \times 8}{2} = 36$ $\frac{10 \times 8}{2} = 40$
18. (B) $(17 + 5) \times 2.5 = 55$
 $(8 + 4) \times 2.5 = 30$
 $(28 + 4) \times 2.5 = 80$

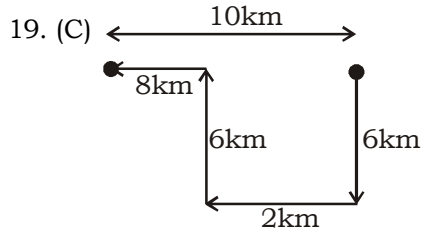

- \therefore He is now 10km west with respect to his starting position.
20. (C) Required number of squares = 8
21. (C) Required number of players who play cricket = 18
22. (C) We sleep at 'night'. But 'night' is called 'sunshine'. So, we sleep at 'Sunshine'.
23. (A) ABKLM.....YZ
- ```

 graph LR
 A -- 11 --> B
 B -- 12th --> C
 C -- 15th --> D
 D -- 14 --> E

```

26. (B) As, Pedology is the study of soil. Similarly, Helminthology is the study of worms.

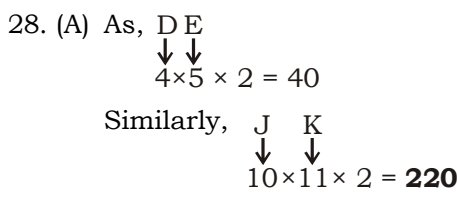
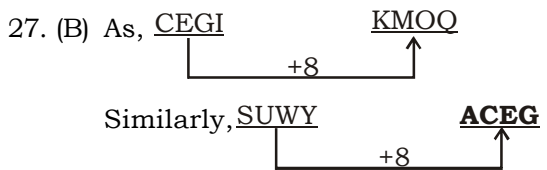

29. (D) Except 'UIE' others are consonants.  
 30. (C) Except 'Carrot', others are good sources of Vitamin C.  
 31. (C) Except "11 - 112", In others, latter is the multiple of former.  
 32. (D) Exalt → Exasperation → Exonerate → Experience → Expertise  
 33. (C) 28 Feb. 1995 → **Saturday**  
 28 Feb. 1996 → Saturday + 1 = Sunday  
 28 Feb. 1997 → Sunday + 2 = Tuesday  
[\*: 1996 leap year]

34. (C) 44 times  
 35. (A) NATIONAL  
 36. (C)  $\frac{OTY}{+1}, \frac{PUZ}{+1}, \frac{QVA}{+1}, \frac{RWB}{+1}, \frac{SXC}{+1}$   
 37. (A)  $\frac{43}{-7.5}, \frac{35.5}{-6}, \frac{29.5}{-4.5}, \frac{25}{-3}, \frac{22}{-1.5}, \frac{20.5}{-1.5}$   
 38. (D)  $\frac{D}{+3}, \frac{G}{+4}, \frac{K}{+3}, \frac{N}{+4}, \frac{R}{+3}, \frac{U}{+3}$

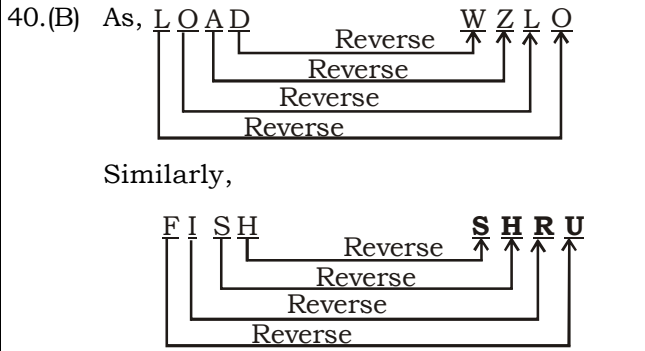
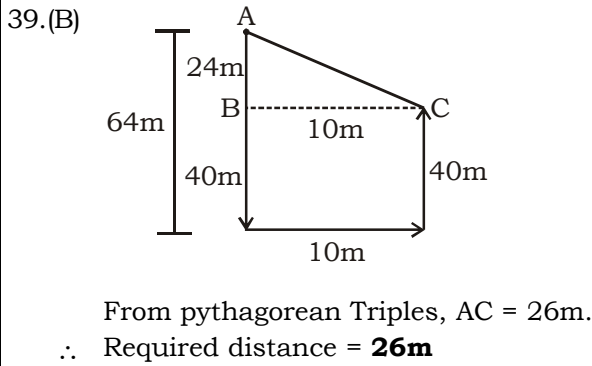

41. (B)  $24 - 8 + 12 \div 22 \times 18$   
 After changing the signs, as per the given details,  
 $24 \times 8 \div 12 + 22 - 18 = 20$

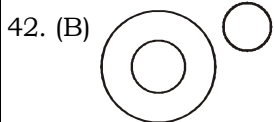

44. (A)  $\frac{Handsones}{Punjabis}, \frac{Prime Minister}$   
 I. Ture II. True  
 Hence, Both I and II follow.

45. (C)  
 46. (B)  $19 + 8 = 27$   
 $14 + 5 = 19$   
 $40 + 11 = 51$   
 47. (B)  $(9 \times 7 \times 2) - 1 = 125$   
 $(6 \times 4 \times 3) - 1 = 71$   
 Similarly,  $(5 \times 8 \times 7) - 1 = 279$

52. (C) Base rate is the minimum rate set by the Reserve Bank of India below which banks are not allowed to lend to its customers. The new Base Rate as fixed by RBI is 8.65% to 9.45% p.a.
- The current CRR is 4% p.a.
  - The current SLR is set at 19.5% p.a.
  - The current MCLR (overnight) stands at 7.70% to 8.10% p.a. at the State Bank of India.
53. (B) In 1944, Shriman Naryan Agarwal introduced a plan whose basic elements followed the Gandhian principle and was a modest kind of plan. It is known as Gandhian Plan, as it was based upon Gandhian philosophy.
54. (A) Coup is sudden overthrow of a government illegally. There are two ways in which it happens - a military coup, and a mass uprising.
56. (C) On 29 August 1947, the Constituent Assembly set up a Drafting Committee under the Chairmanship of Dr. B.R. Ambedkar to prepare a draft Constitution for India.
57. (D) Article 21 of the Indian Constitution, 1950, guarantees the right to life to all persons within the territory of India and states: "No person shall be deprived of his right to life and personal liberty except according to procedure established by law."
58. (A) Sarfaroshi ki Tamanna is a patriotic poem written in Urdu by Bismil Azimabadi of Patna in 1921, and then it was also immortalised by Ram Prasad Bismil as a freedom war cry during the British Raj period in India.
59. (C) Jizyah tax was abolished by the third Mughal emperor Akbar, in 1564. It was finally abolished in 1579. However, Aurangzeb, the sixth emperor, re-introduced and levied jizya on non-

- Muslims in 1679. His goal was to promote Islam and weaken the Hindu religion.
60. (B) Historical event in the chronological order of the occurrence:
1. Non-Cooperation movement, unsuccessful attempt in 1920, organized by Mohandas (Mahatma) Gandhi.
  2. The Chauri Chaura incident occurred at Chauri Chaura in the Gorakhpur district of the United Province, (modern Uttar Pradesh) in British India on 5<sup>th</sup> February, 1922.
  3. On March 12, 1930, Indian independence leader Mohandas Gandhi began a defiant march to the sea in protest of the British monopoly on salt, his boldest act of civil disobedience against British rule in India.
61. (C) Navaratna was a term applied to a group of nine extraordinary people in a king's court in India. Akbar's court's fame lies in the navratna that were present. They were:
- Abul-Fazel: Akbar's chief advisor and author of Akbarnama.
  - Faizi: Poet laureate of Akbar's Court.
  - Miyan Tansen :Legendary Musician, well known for his voice and music.
  - Birbal : Akbar's Prime Minister who was well known for his intelligence and wit.
  - Raja Todar Mal :Akbar's finance minister.
  - Raja Man Singh :The Kacchwaha Rajput Raja of Amber (Jaipur), Akbar's trusted general and Commander-in-chief.
  - Abdul Rahim Khan-I: Khanawas a poet and son of Akbar's trusted protector and care taker, Bairam Khan.
  - Fakir Aziao-Din :Advisor to Akbar, the Fakir and also a mystic.
  - Mullah Do Piazza :One of Akbar's advisors.
62. (C) The Kalahari Desert is a large semi-arid sandy savanna in Southern Africa extending for 900,000 square kilometers (350,000 sq. mi), covering much of Botswana, parts of Namibia and regions of South Africa.
63. (C) The Great Barrier Reef is in the Coral Sea, on Australia's north-eastern coast. It stretches more than 2,300km along the state of Queensland's coastline, beginning at the tip of Cape York Peninsula in the north and extending down to Bundaberg in the south.
64. (A) The maxwell, abbreviated as Mx, is the compound derived CGS unit of magnetic flux. The unit was previously called a line.
- SI units:  $1 \times 10^{-8} \text{ Wb}$
  - Unit of : Magnetic flux
- Unit system : Gaussian units
  - Gaussian base units:  $1 \text{ cm} \frac{3}{2} \cdot \text{g} \frac{1}{2} \cdot \text{s}^{-1}$
69. (B) The atomic nucleus is the small, dense region consisting of protons and neutrons at the center of an atom, discovered in 1911 by Ernest Rutherford.
70. (A) Aqua Regia is a mixture of nitric acid and hydrochloric acid, optimally in a molar ratio of 1:3. Aqua Regia is a yellow-orange fuming liquid, so named by alchemists because it can dissolve the noble metals gold and platinum, though not all metals.
73. (C) The Turkmenistan-Afghanistan-Pakistan-India Natural Gas Pipeline (TAPI) Project aims to export up to 33 billion cubic meters (bcm) of natural gas per year through a proposed approximately 1,800-kilometer (km) pipeline from Turkmenistan to Afghanistan, Pakistan and India.
74. (C) The longest bone in the human body is the femur. The head of the femur articulates with the acetabulum in the pelvic bone forming the hip joint, while the distal part of the femur articulates with the tibia and knee cap forming the knee joint. By most measures the femur is the strongest bone in the body.
75. (B) White blood cells (WBCs), also called leukocytes, are the cells of the immune system that are involved in protecting the body against both infectious disease and foreign invaders. All white blood cells are produced and derived from multipotent cells in the bone marrow known as hematopoietic stem cells.
77. (D) The **parliament** is the supreme law making institution. Rajya Sabha or the upper house of the parliament is the supreme law making institution in India.
78. (B) The **Harshacharita**, is the biography of Indian emperor Harsha by **Banabhatta**, also known as **Bana**, who was a **Sanskrit** writer of seventh-century CE India. He was the Asthana Kavi, meaning **Court Poet, of Harsha**.
79. (B) The second **Swadeshi movement** started with the partition of Bengal by the Viceroy of India, Lord Curzon in **1905** and continued up to 1911. It was the most successful of the pre-Gandhian movement.
82. (A) **Bandhani** is a technique of tie and dye. The term "bandhani" derives its name from the Hindi word Bandhan which

- means tying up. Bandhani is an ancient art practiced by people mainly of **Rajasthan and Gujarat**.
84. (C) **Dholavira** is an archaeological site at Khadirbet in Bhachau Taluka of Kutch District, in the state of **Gujarat in western India**. Also known locally as Kotada timba, the site contains ruins of an ancient Indus Valley Civilization/ Harappan city.
85. (B) Fold Mountains occur near convergent or compressional plate boundaries. Examples of Fold Mountains include the **Alps, Rockies, Andes and Himalayas**.
86. (A) The pancreas produces 2 antagonistic hormones to control blood sugar: **glucagon and insulin**. The alpha cells of the pancreas produce glucagon. The pancreas also produces the hormone insulin and secretes it into the bloodstream, where it regulates the body's glucose or sugar level.
87. (A) Microsoft Windows OS uses two major file systems: **FAT**, inherited from old DOS with its later extension **FAT32**, and widely-used NTFS file systems.
88. (B) Pradhan Mantri Krishi Sinchayee Yojana was launched on **1<sup>st</sup> July, 2015** with the **motto of "Har Khet Ko Paani"**. It is a national mission to improve farm productivity and ensure better utilization of the resources in the country. **Tagline** for PMKSY is "**more crop per drop**".
89. (D) **Squash, Lawn-tennis, Badminton and Table-tennis** sports involves use of **Rackets**. Racketlon is a combination sport in which competitors play a sequence of the four most popular racket sports: table tennis, badminton, squash, and tennis.
90. (D) The 1988 Maldives coups detat was the attempt by a group of Maldivians led by Abdullah Luthufi and assisted by armed mercenaries of a Tamil secessionist organization from Sri Lanka, the People's Liberation Organization of Tamil Eelam (PLOTE), to overthrow the government in the island republic of Maldives. The coup detat failed due to the intervention of the Indian Army, whose military operations efforts were **code-named Operation Cactus** by the **Indian Armed Forces**. The operation started on the night of **3 November 1988**.
91. (B) In economics, tools, machines, buildings that can be used production over many years are called **fixed capital**. Thus, fixed capital has a permanent existence in the business. It is usually present in the form of fixed assets like land, building, plant, machinery, etc.
92. (C) **Natural gas** is a **fossil fuel** used as a source of energy for heating, cooking, and electricity generation. Fossil fuel based natural gas is a **non-renewable resource**. Like oil, it is formed from the remains of marine microorganisms.
93. (C) These are islands, submerged reefs, or islets that have been disputed for **sovereignty**. Usually the surrounding waters are considered in dispute as well. Sovereignty over the **Chagos Archipelago** is disputed between **Mauritius and the United Kingdom**.
94. (B) The **India-Myanmar-Thailand Trilateral Highway** is a highway under construction under India's Look East policy that will connect Moreh, India with Mae Sot, Thailand via Myanmar. The road is expected to boost trade and commerce in the ASEAN-India Free Trade Area, as well as with the rest of Southeast Asia. India has also proposed extending the highway to **Cambodia, Laos and Vietnam**.
95. (B) The image formed by a **plane mirror** is always **virtual, upright**, and of the **same shape and size as the object** it is reflecting. A virtual image is a copy of an object formed at the location from which the light rays appear to come.
96. (A) The **Trans-Siberian Railway** is the name given to the three rail routes that traverse Siberia from Moscow. With a length of **9,289 kilometers**, it is the longest continental railway line in the world. The railway is often associated with the main transcontinental Russian line that connects hundreds of large and small cities of the **European and Asian parts of Russia**.
98. (C) Peroxyacetyl nitrate is a peroxyacetyl nitrate. It is a **secondary pollutant present in photochemical smog**. It is thermally unstable and decomposes into peroxyethanoyl radicals and nitrogen dioxide gas. It is a lachrymatory substance.



99. (D) **Photoperiodism** is the physiological reaction of organisms to the length of day or night. It occurs in plants and animals. Plant growth and development processes that are affected by photoperiod include **flowering, vegetative growth, internode elongation**; tuber, rhizome and bulb formation, sex expression, the formation of pigments such as anthocyanin, the number and size of root nodules, fruit set, leaf fall and dormancy.

100. (D) Net national product (NNP) is the market value of a nation's goods and services minus depreciation (often referred to as capital consumption).

NNP can be calculated as: **NNP = Gross National Product - Depreciation**

$$101.(C) pu_{new} = pu_{old} = \left( \frac{MVA_{new}}{MVA_{old}} \right) \left( \frac{KV_{old}}{KV_{new}} \right)^2$$

$$= 0.15 \times \left( \frac{1/2}{1} \right) \left( \frac{1}{1/2} \right)^2$$

$$= 0.15 \times \frac{1}{2} \times 42 = pu_{new} = 0.30$$

108.(A)  $V_{reading} \propto i^2$

$$\frac{100}{V} = \left( \frac{1 \times 10^{-3}}{0.5 \times 10^{-3}} \right)^2$$

$$v = 100 \times 0.25$$

$$= 25 \text{ volt}$$

111.(A)  $I = \frac{0.5}{100000}$

$$R_{voltmeter} = \frac{49.5}{0.5} \times 100000$$

$$= 99,00,000 \Omega$$

$$= 9.9M\Omega$$

$$\approx 10M\Omega$$

to achieve accuracy better than 99%, the resistance of voltmeter must be greater than 10 MΩ

112.(B) Sensitivity =  $\frac{1}{\text{full scale deflection}}$

114.(A) The stepping angle =  $\frac{360^\circ}{n \times p} = \frac{360}{6 \times 12} = 5^\circ$

117.(C)  $\frac{T_{st}}{T_{fl}} = \left( \frac{I_{st}}{I_{fe}} \right)^2 \propto s$

$$\frac{T_{st}}{T_{fl}} = \left( \frac{5}{1} \right)^2 \times 0.04$$

$$\frac{T_{st}}{T_{fl}} = 1.00$$

118.(C)  $P_{cu_{new}} = x^2 P_{cu_{old}}$

$$= \left( \frac{1}{2} \right)^2 \times 6400$$

$$P_{cu} = 1600 \text{ W}$$

$P_{iron}$  remains constant because iron loss does not depend upon the load.

132.(A) number of loop equation =  $b - n + 1$   
 $= 10 - 7 + 1 = 4$

136.(B) Current coil is connected in series with the load and carries the load current if the coils are interchanged, current coils get directly connected across the supply. Large current flows through the coil resulting into damage to current coil.

156.(D) Transformers are generally step up transformer with LV winding (i.e. primary) connected in Delta and HV winding (i.e. secondary) connected in star

*advantage of using transformer primary in delta are-*

(i) The line current gets divided by  $\sqrt{3}$

(ii) Delta connection provides path for the 3rd order harmonic current.

*- advantage of using transformer's secondary in star*

(i) the ratio of secondary to primary line voltage is  $\sqrt{3} k$

160.(B) Two capacitors connected in series. then

$$\frac{1}{C_{eq}} = \frac{1}{3} + \frac{1}{6}$$

$$C_{eq} = \frac{3 \times 6}{3 + 6}$$

$$C_{eq} = 2 \mu\text{F}$$

162.(C)  $E_g = \frac{5 \times 300}{6} = 250 \text{ volt}$

165.(A) maximum efficiency occurs at a load of

$$= \text{KVA} \times \sqrt{\frac{P_i}{P_{cu}}}$$

$$= 100 \times \sqrt{\frac{1}{2}}$$

$$= \frac{100}{\sqrt{2}} \text{ KVA}$$

171.(A) Total power dissipation =  $\frac{P_1 P_2}{P_1 + P_2} = \frac{60 \times 100}{60 + 100}$

$$= \frac{6000}{160} = 37.5 \text{ watt}$$

176. (C) when the conductor supports are at equal level then Sag is =  $\frac{WL^2}{8T}$

where W is weight per unit length of conductor

L = Horizontal distance between the towers i.e. span

T = Tension in the conductor

185.(A) The material used for fuse elements must be of low melting point, low ohmic loss, high conductivity (or low resistivity ) etc.