

SSC MOCK TEST - 360 (SOLUTION)

1. (B) As,

$$T_{20} \xrightarrow{+3} W_{23}$$

$$P_{16} \xrightarrow{-3} M_{13}$$

$$J_{10} \xrightarrow{+3} M_{13}$$

$$K_{11} \xrightarrow{-3} H_8$$

Similarly,

$$R_{18} \xrightarrow{+3} U_{21}$$

$$K_{11} \xrightarrow{-3} H_8$$

$$L_{12} \xrightarrow{+3} O_{15}$$

$$D_4 \xrightarrow{-3} A_1$$

2. (A) Hollow is related to worthless, while solid is related to sound.

3. (D) 'Henry', 'Siemen', Hertz are Measuring unit of Inductance, Conductance and Frequency respectively, while Resistance is a electrical parameter whose measuring unit is ohm.

4. (C) The numbers 93165, 36747 and 76137 are divisible by 3, while 85253 is not divisible by 3.

5. (B) B⁻

|

D⁺

|

M⁺

—— N

Hence, M is the grandson of B.

6. (D) As,

$$14 \xrightarrow{\times \frac{14}{2}} 98$$

$$12 \xrightarrow{\times \frac{12}{2}} 72$$

Similarly,

$$8 \xrightarrow{\times \frac{8}{2}} 32$$

7. (B) D ← opposite → W, A ↓ -1

X ← opposite → C, Z ↓ -1

P ← opposite → K, Y

8. (A) As, $13 \times 3 - 2 = 37$

$$37 \times 2 + 3 = 77$$

$$\text{Similarly, } 14 \times 3 - 2 = 40$$

$$40 \times 2 + 3 = 83$$

9. (C) H E M A / H E M A / H E M A / H E M A

10. (B)

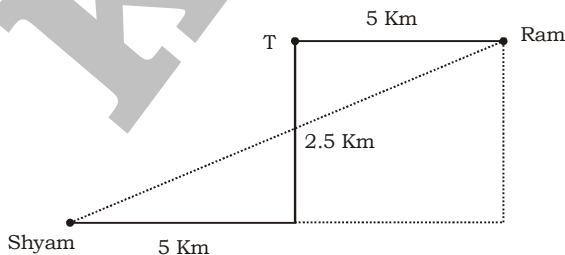

$$\text{Required distance} = \sqrt{10^2 + (2.5)^2} = \sqrt{100 + 6.25} = \sqrt{106.25} \text{ km}$$

11. (D)



12. (B) As, $3 \times 2 \times 2 = 12$

$$5 \times 2 \times 5.5 = 55$$

$$\text{Similarly, } -2 \times 6 \times 2.8 = -33.6$$

13. (B) $8 + 12 \div 6 \times 8 - 9 = 8$

Change \times and \div ,

$$8 + 12 \times 6 \div 8 - 9 = 8$$

$$8 + 9 - 9 = 8$$

$$8 = 8$$

14. (A) 6. Elbow \rightarrow 3. Finger \rightarrow 2. Nails \rightarrow 4. Palm \rightarrow 5. Shoulder \rightarrow 1. Wrist

15. (A) As,

S	T	R	O	K	E
H	G	J	L	P	V
8	7	9	12	16	22
					Reverse order
22	16	12	9	7	8
+1	+1	+1	+1	+1	+1
23	17	13	10	8	9

And,

G	L	U	T	E	N
T	O	F	G	V	M
20	15	6	7	22	13
					Reverse order
13	22	7	6	15	20
+1	+1	+1	+1	+1	+1
14	23	8	7	16	21

Similarly,

C	H	A	R	G	E
X	S	Z	I	T	V
24	19	26	9	20	22
					Reverse order
22	20	9	26	19	24
+1	+1	+1	+1	+1	+1
23	21	10	27	20	25

16. (C) It was Saturday on 31 December 2005.
 Number of odd days from 2006 to 2010 = $1 + 1 + 2 + 1 + 1 = 6$
 It was Saturday + 6 = Friday on 31 December 2010.
 Hence, it was Sunday on 2 January 2011.

17. (C)

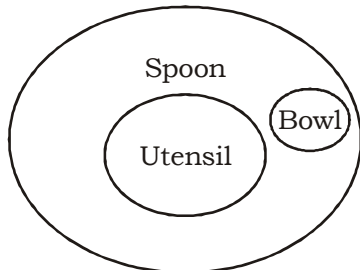

Conclusion:

- I. False II. Can't say III. Can't say
 Hence, either conclusion II or III follows.

18. (C)

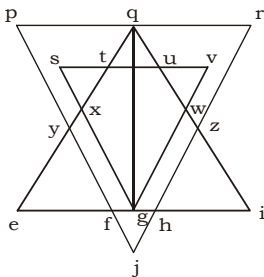

There are three triangles in triangle prj, sgv, qtu, eqi, fhj.
 Number of triangles in above triangle = $3 \times 5 = 15$ and single triangles are = pqy, qrz, yef, zhi, stx, uvw, exg, wgi, qxg, qwg, qyf, qzj = 12
 \therefore Total triangles = $15 + 12 = 27$

19. (A) Let the number of boys be x and number of girls be y.

Total number of students in a class = $x + y$
 Each boy gets 5 apples and each girl gets 7 apples.

ATQ,

$$5x + 7y = 85 \dots\dots(i)$$

and each boy gets 4 apples and each girl gets 9 apples,

$$4x + 9y \dots\dots(ii)$$

Comparing equation (i) and (ii),

$$5x + 7y = 4x + 9y$$

$$x = 2y$$

Putting the value of x in equation (i),

$$5x + 7y = 85$$

$$10y + 7y = 85$$

$$y = \frac{85}{17} = 5$$

Putting the value of y in equation (i),

$$5 \times x + 7 \times 5 = 85$$

$$x = \frac{50}{5} = 10$$

\therefore Total number of students in a class = $5 + 10 = 15$

20. (D) As,

I N T E R A C T
 ↘ ↓ ↙ ↘ ↙ ↘ ↙ ↘
 T N I R E T C A

Similarly,

S A T U R D A Y
 ↘ ↓ ↙ ↘ ↙ ↘ ↙ ↘
 T A S R U Y A D

21. (B)

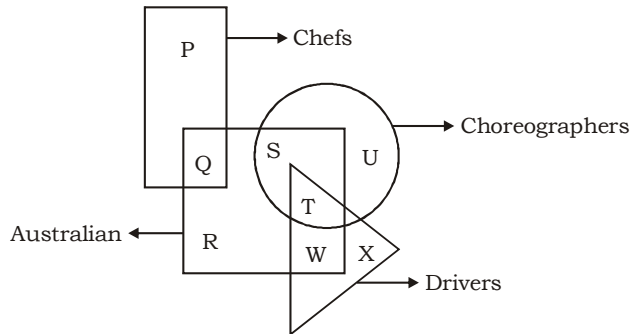

22. (A) Position of Punit from left end = 32

Position of Amit from right = 26

After changing the position, Punit's position from the left end = 55

∴ Total number of boys in the row = 55 + 26 - 1 = 80

23. (D) 24. (C) 25. (A)

27. (C) Sundarbans – a UNESCO-listed World Heritage Site. Sundarban has world's largest mangrove forest which is home to wide range of fauna, including 260 bird species, the Bengal tiger and other threatened species such as the estuarine crocodile and the Indian python. It is also home to the rare Irrawaddy dolphin.

29. (A) The World Polio Day is observed on 24th October every year. The day was observed to create awareness about the hazards of the crippling disease. The Day was established by Rotary International over a decade ago to commemorate the birth of Jonas Salk, who led the first team to develop a vaccine against poliomyelitis.

31. (D) Central Vigilance Commissioner and the Vigilance Commissioners would be four years from the date of entering office or till they attain the age of 65 years, whichever is earlier.

33. (C) During his five year rule from 1540 to 1545, Sher Shah Suri set up a new civic and military administration, issued the first Rupiya and reorganised the postal system of India.

34. (D) Two major measures for inflation, which are widely used, are Wholesale Price Index (WPI) and Consumer Price Index (CPI). WPI measures the increase in the prices of a fixed basket of goods prevailing in the wholesale market while CPI measures the increase in the prices of essential commodities purchased by an average consumer prevailing in the retail market. Measured weekly, WPI is the primary inflation measure in India. 35. (B) The earliest evidence of Agriculture in Indian subcontinent is found at Mehrgarh, which is located in Balochistan state of Pakistan.

36. (B) Union Home Minister Amit Shah launched the mascot and the anthem for the 36th National Games in Ahmedabad.

38. (A) Abanindranath Tagore had founded Indian Society of Oriental Art in Kolkata to revive the ancient art traditions of India. He was the principal of government school of art and a great artist of modern India.

39. (B) As an ambassador of Emperor James -I, Sir Thomas Roe reached in the court of Mughal Emperor Jehandri at Agra in 1615. Jehangir presented him the Mansab of 400.

40. (B) According to the provisions of article 312, the Parliament can create a new all India service, if resolution to that effect in national interest is passed by the council of states.

42. (B) Central dogma of molecular biology describes the flow of genetic information in cells from DNA to messenger RNA (mRNA) to protein.
43. (C) India's National Security Council Secretariat (NSCS) and the UK Government in collaboration with BAE Systems successfully conducted the Cyber Security Exercise for 26 Countries.
44. (A) Mount Vinson is the highest peak in Antarctica, with an elevation of 16,066 feet (4,897 ters). It is located on the southern part of the main ridge of the Sentinel Range of the Ellsworth Mountains.
45. (A) The Sakas came to India through the Bolan Pass. They were a Scythian tribe or group of tribes of Iranian origin.
48. (B) The Itaipu hydroelectric power plant is second largest hydropower plant in Brazil. The project is located on the Parana River, at the border between Brazil and Paraguay. Itaipu dam with an installed capacity of 14,000MW ranks as the world's second largest hydropower plant.
49. (D) The bulk of the Central Government subsidies arise on the provision of economic services, which account for 88% of the total subsidies (10% on merit services and 78% on non-merit).
51. (A) Let total share of A, B and C = 24 unit

$$\text{A's share} = 24 \times \frac{1}{6} = 4 \text{ unit}$$

$$\text{B's share} = 24 \times \frac{1}{8} = 3 \text{ unit}$$

$$\text{C's share} = 24 \times \frac{1}{3} = 8 \text{ unit}$$

Let total time for investment = 12 unit

$$\text{A's time} = 12 \times \frac{3}{4} = 9 \text{ unit}$$

$$\text{B's time} = 12 \times \frac{1}{2} = 6 \text{ unit}$$

$$\text{C's time} = 12 \times \frac{1}{3} = 4 \text{ unit}$$

	A	B	C
Investment	4	3	8
Time	9	6	4
Profit	36	18	32
	18	9	16

Profit of B and C = (16 + 9) = 25

$$25 = 750$$

$$1 = 30$$

$$\text{A's share} = 18 \times 30 = ₹540$$

52. (D) Number of cones = $\frac{\text{Volume of sphere}}{\text{Volume of cone}}$

$$= \frac{\frac{4}{3}\pi(10.5)^3}{\frac{1}{3}\pi(3.5)^2 \times 3} = \frac{4 \times 10.5 \times 10.5 \times 10.5}{3.5 \times 3.5 \times 3} = 126$$

53. (C) $\sin^4 \theta - \cos^4 \theta = \frac{1}{5}$

$$(\sin^2 \theta)^2 - (\cos^2 \theta)^2 = \frac{1}{5}$$

$$\sin^2 \theta + \cos^2 \theta = 1 \quad \dots\dots(i)$$

$$\sin^2 \theta - \cos^2 \theta = \frac{1}{5} \quad \dots\dots(ii)$$

Solving equation (i) and (ii),

$$2\cos^2 \theta = \frac{4}{5}$$

$$\cos^2 \theta = \frac{2}{5}$$

$$\cos^2 \theta + 1 = \frac{2}{5} + 1 = \frac{7}{5}$$

54. (B) Let the CP be ₹ 100.

$$SP = 100 \times \frac{120}{100} = ₹ 120$$

$$MP = \frac{120}{75} \times 100 = ₹ 160$$

$$\text{Profit} = 120 - 100 = ₹ 20$$

$$20 \text{ unit} \rightarrow 60$$

$$100 \text{ unit} \rightarrow \frac{60}{20} \times 100 = ₹ 300$$

55. (D) Sum of temperature of Sunday + Monday + Tuesday = $(30 \times 3)^\circ\text{C} = 90^\circ\text{C} \quad \dots\dots(i)$

Sum of temperature of Monday + Tuesday + Wednesday = $(27 \times 3)^\circ\text{C} = 81^\circ\text{C} \quad \dots\dots(ii)$

Subtract equation (ii) from (i)

$$\text{Sunday} - \text{Wednesday} = 9^\circ\text{C}$$

$$\text{Sunday} - \frac{2}{3}\text{Sunday} = 9^\circ\text{C}$$

$$\frac{\text{Sunday}}{3} = 9^\circ\text{C}$$

$$\text{Sunday} = 27^\circ\text{C}$$

$$\text{Temperature of Wednesday} = \left(27^\circ \times \frac{2}{3}\right) = 18^\circ\text{C}$$

56. (D) $3\frac{4}{5} \div \left(5\frac{3}{7} \div \frac{2}{7} \text{ of } 1\frac{1}{4}\right) \times \left[\left(2\frac{3}{4} \div 4\frac{2}{5}\right) \text{ of } 1\frac{3}{5}\right]$

$$= \frac{19}{5} \div \left(\frac{38}{7} \div \frac{2}{7} \text{ of } \frac{5}{4}\right) \times \left[\left(\frac{11}{4} \div \frac{22}{5}\right) \text{ of } \frac{8}{5}\right]$$

$$= \frac{19}{5} \div \left(\frac{38}{7} \div \frac{5}{14}\right) \times \left[\left(\frac{11}{4} \times \frac{5}{22}\right) \text{ of } \frac{8}{5}\right]$$

$$= \frac{19}{5} \div \left(\frac{38}{7} \times \frac{14}{5}\right) \times \left[\left(\frac{5}{8} \times \frac{8}{5}\right)\right]$$

$$= \frac{19}{5} \div \frac{76}{5} \times 1 = \frac{19}{5} \times \frac{5}{76} = \frac{1}{4}$$

57. (4) Let the number of votes polled be 100.
Arshad got = 35

$$\text{Chamanlal got} = \frac{14}{35} \times 100 = 40$$

$$\text{Jagjit got} = 100 - (35 + 40) = 25$$

ATQ,

$$(40 - 25) \rightarrow 4950$$

$$100 \rightarrow \frac{4950}{15} \times 100 = 33000$$

58. (D)

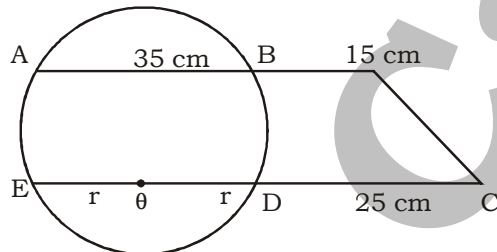

$$BC \times AC = CD \times CE$$

$$15 \times 35 = (25 - r)(25 + r)$$

$$525 = 625 - r^2$$

$$r^2 = 625 - 525$$

$$r^2 = 100$$

$$r = 10 \text{ cm}$$

59. (D) Ratio of share of x and y = $(12 : 13) \times 2 = 24 : 26$

$$\text{Ratio of share of y and z} = 26 : 27$$

$$\text{Ratio of share of x, y and z} = 24 : 26 : 27$$

ATQ,

$$(27 - 24) \text{ units} = ₹ 315$$

$$3 \text{ units} = ₹ 315$$

$$1 \text{ units} = ₹ \frac{315}{3} = ₹ 105$$

$$A = (x + y + z) = (24 + 26 + 27) \text{ units} = 77 \text{ units}$$

$$A = (77 \times 105) = ₹ 8085$$

60. (A) Let the number of boys = 100
Number of girls = 40

$$\therefore \text{Average age of class} = \frac{100 \times 24 + 40 \times 24 \times \frac{75}{100}}{140} = \frac{2400 + 720}{140}$$

$$= \frac{3120}{140} = 22 \frac{2}{7} \text{ years}$$

61. (B) $\frac{x-1}{y-1} = \frac{1}{3}$

$$3x - 3 = y - 1$$

$$y = 3x - 2 \quad \text{--- (i)}$$

$$\frac{x+1}{y+1} = \frac{1}{2}$$

$$2x + 2 = y + 1$$

Substituting value of y ,

$$2x + 2 = 3x - 2 + 1$$

$$x = 2 + 2 - 1 = 3$$

$$y = 3 \times 3 - 2 = 7$$

$$\text{Required fraction} = \frac{3}{7}$$

62. (A) HCF of two numbers = 3

Hence, the numbers can be given by $3x$ and $3y$ {where x and y are co-prime}

$$3x + 3y = 24$$

$$x + y = 8$$

Possible pairs $\Rightarrow (1, 7) (3, 5)$

63. (D) $\sin^6 A + \cos^6 A + 3\sin^2 A \cos^2 A = (\sin^2 A)^3 + (\cos^2 A)^3 + 3\sin^2 A \cos^2 A (\sin^2 A + \cos^2 A)$ [$\sin^2 A + \cos^2 A = 1$]
 $= [\sin^2 A + \cos^2 A]^3 = 1$

64. (A) Equal amounts are spent on both types of guavas.

So, in ₹1 first type apple bought = 3

In ₹ 1 second type of apple bought = 2

If he sells 5 apple in ₹ 2, so overall he neither gains nor loses.

65. (D) Relative speed = $(50 - 30)$ km/hr = 20 km/hr = $20 \times \frac{5}{18} = \frac{50}{9}$ m/s

$$\text{Length of train running at } 50 \text{ km/hr} = \frac{50}{9} \times 18 = 100 \text{ m}$$

66. (C)

67. (A) Diameter = 8.4 m

$$\text{Height} = 1.75 \text{ m}$$

$$\text{Radius} = 4.2 \text{ cm}$$

$$l = \sqrt{(4.2)^2 + (1.75)^2} = 4.55 \text{ m}$$

$$\therefore \text{Required area} = \pi r l = \frac{22}{7} \times 4.2 \times 4.55 = 60.06 \text{ m}^2$$

68. (B) Let BC is a tower and its height is x and AB is a pole.

In $\triangle BCP$,

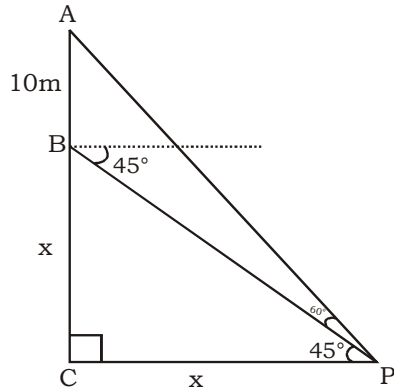

$$\tan 45^\circ = \frac{BC}{CP}$$

$$1 = \frac{x}{CP}$$

$$CP = x \text{ m}$$

In $\triangle ACP$,

$$\tan 60^\circ = \frac{AC}{CP}$$

$$\sqrt{3} = \frac{10 + x}{x}$$

$$\sqrt{3}x = 10 + x$$

$$\sqrt{3}x - x = 10$$

$$x(\sqrt{3} - 1) = 10$$

$$x = \frac{10}{\sqrt{3} - 1} \times \frac{\sqrt{3} + 1}{\sqrt{3} + 1} = \frac{10(\sqrt{3} + 1)}{2} = 5(\sqrt{3} + 1)$$

$$= 5(1.732 + 1) = 5 \times 2.732 = 13.66 \text{ m}$$

69. (D) $\frac{\sec^2 54^\circ - \cot^2 36^\circ}{\operatorname{cosec}^2 57^\circ - \tan^2 33^\circ} + 2 \sin^2 38^\circ \sec^2 52^\circ - \sin^2 45^\circ$

$$= \frac{\sec^2 54^\circ - \cot^2 (90^\circ - 54^\circ)}{\operatorname{cosec}^2 57^\circ - \tan^2 (90^\circ - 57^\circ)} + 2 \sin^2 38^\circ \sec^2 (90^\circ - 38^\circ) - \sin^2 45^\circ$$

$$= \frac{\sec^2 54^\circ - \tan^2 54^\circ}{\operatorname{cosec}^2 57^\circ - \cot^2 57^\circ} + 2 \sin^2 38^\circ \cdot \operatorname{cosec}^2 38^\circ - \sin^2 45^\circ$$

$$= \frac{1}{1} + 2 - \left(\frac{1}{\sqrt{2}}\right)^2 = 3 - \frac{1}{2} = \frac{5}{2}$$

70. (B) Area of enclosed ring = 286 cm²

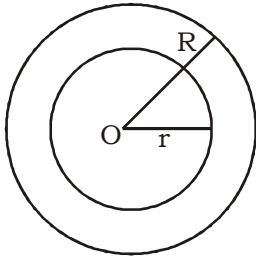

$$R - r = 7 \text{ cm} \dots\dots(i) \text{ (given)}$$

ATQ,

$$\pi R^2 - \pi r^2 = 286$$

$$\pi(R^2 - r^2) = 286$$

$$R^2 - r^2 = \frac{286}{22} \times 7$$

$$(R + r)(R - r) = 91$$

$$(R + r)(7) = 91 \quad [\because (R - r) = 7 \text{ cm}]$$

$$R + r = \frac{91}{7} = 13 \quad \dots\dots(ii)$$

Adding equation (i) and (ii), we get

$$\begin{array}{r} R - r = 7 \\ R + r = 13 \\ \hline 2R = 20 \end{array}$$

$$R = \frac{20}{2} = 10 \text{ cm}$$

Put the value of R in equation (i),

$$R - r = 7$$

$$10 - r = 7$$

$$r = 10 - 7 = 3 \text{ cm}$$

\therefore Radii of circles are 10 cm and 3 cm.

71. (A) Let the amount given at 8% be ₹ x.

$$\text{Amount given at } \frac{4}{3}\% = ₹ (20000 - x)$$

ATQ,

$$\frac{x \times 8 \times 1}{100} + \frac{(20000 - x) \times 4 \times 1}{3 \times 100} = 800$$

$$\frac{8x}{100} + \frac{80000 - 4x}{300} = 800$$

$$24x - 4x + 80000 = 240000$$

$$20x = 160000$$

$$x = \frac{160000}{20} = ₹ 8000$$

72. (B) Line $3x + 4y = 12$ intersects the y-axis at A (0, 3) and x-axis at B = (4, 0)
Line $6x + 8y = 60$ intersects the y-axis at D (0, 7.5) and x-axis at C = (10, 0)
Hence ABCD is the trapezium for which the area is to calculate.

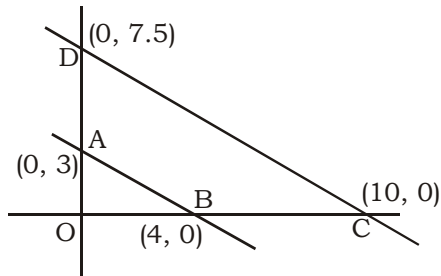

Area of trapezium ABCF = Area of $\triangle ODC$ - area of $\triangle OAB$

$$= \frac{1}{2}(10 \times 7.5) - \frac{1}{2}(4 \times 3) = 37.5 - 6 = 31.5 \text{ sq. unit}$$

73. (D) For the publisher to earn a profit of 25%, S.P. = 125% of C.P.
Also transportation Cost = 10% of C.P.
Let the S.P. of 5500 books be ₹ x.
 $10 : 125 = 82500 : x$

$$x = \frac{125 \times 82500}{10}$$

$$x = 1031250$$

$$\text{S.P. of one book} = \frac{1031250}{5500} = ₹187.50$$

74. (B) Printing cost of book = 20% of C.P.
Royalty on book = 15% of C.P.
Difference = (20% - 15%) = 5% of C.P.

$$\text{Percentage difference} = \left(\frac{\text{Difference}}{\text{Printing Cost}} \times 100 \right) \%$$

$$= \left(\frac{5\% \text{ of C.P.}}{20\% \text{ of C.P.}} \times 100 \right) \% = 25\%$$

75. (D) Let the royalty to be paid for these books be ₹ r.
ATQ,

$$20 : 15 = 30600 : r$$

$$r = \frac{30600 \times 15}{20}$$

$$r = 22950$$

∴ Amount of royalty to be paid = ₹ 22950

MEANINGS IN ALPHABETICAL ORDER

Audacious	showing a willingness to take surprisingly bold risks	साहसी
Chum	a close friend	घनिष्ठ मित्र
Comic	causing or meant to cause laughter	हास्यपूर्ण
Conducive	making a certain situation or outcome likely or possible	प्रेरक, सहायक
Deify	worship, regard, or treat (someone or something) as a god	देवता तुल्य मानना
Dissipation	the squandering of money, energy, or resources	लपेटना
Eccentric	(of a person or their behavior) unconventional and slightly strange	सनकी
Endocrinology	the branch of physiology and medicine concerned with endocrine glands and hormones	एंडोक्राइन ग्रंथियों और हार्मोन से संबंधित शरीर विज्ञान और चिकित्सा की शाखा
Flatter	praise dishonestly	खुशामद करना
Frantic	wild or distraught with fear, anxiety, or other emotion	उन्मत्त, उग्र
Geriatrics	the branch of medicine or social science dealing with the health and care of old people	वृद्धावस्था और उनके रोगों से संबंधित चिकित्सा शास्त्र की शाखा
Hurriedly	in a quick or hasty manner	शीघ्रता से
Incompatible	(of two things) so opposed in character as to be incapable of existing together	बेमेल
Incomprehensible	not able to be understood	जो समझा न जा सके
Inconsequent	not connected or following logically; irrelevant	असंगत
Infatuated	possessed with an intense but short-lived passion or admiration for someone	मुग्ध
Laurels	praise	प्रशंसा
Morbid	of the nature of or indicative of disease	बीमार
Obstetrics	the branch of medicine and surgery concerned with childbirth and the care of women giving birth	प्रसूति-विज्ञान
Oncology	the study and treatment of tumors	ट्यूमर का अध्ययन और उपचार का विज्ञान
Peer	make or become equal with or of the same rank	समान पद का

SSC MOCK TEST - 360 (ANSWER KEY)

- | | | | |
|---------|---------|---------|----------|
| 1. (B) | 26. (C) | 51. (A) | 76. (C) |
| 2. (A) | 27. (C) | 52. (D) | 77. (A) |
| 3. (D) | 28. (D) | 53. (C) | 78. (D) |
| 4. (C) | 29. (A) | 54. (B) | 79. (B) |
| 5. (B) | 30. (A) | 55. (D) | 80. (C) |
| 6. (D) | 31. (D) | 56. (D) | 81. (A) |
| 7. (B) | 32. (B) | 57. (A) | 82. (C) |
| 8. (A) | 33. (C) | 58. (D) | 83. (A) |
| 9. (C) | 34. (D) | 59. (D) | 84. (C) |
| 10. (B) | 35. (B) | 60. (A) | 85. (A) |
| 11. (D) | 36. (B) | 61. (B) | 86. (B) |
| 12. (B) | 37. (B) | 62. (A) | 87. (D) |
| 13. (B) | 38. (A) | 63. (D) | 88. (B) |
| 14. (A) | 39. (B) | 64. (A) | 89. (C) |
| 15. (A) | 40. (B) | 65. (D) | 90. (D) |
| 16. (C) | 41. (C) | 66. (C) | 91. (D) |
| 17. (C) | 42. (B) | 67. (A) | 92. (D) |
| 18. (C) | 43. (C) | 68. (B) | 93. (D) |
| 19. (A) | 44. (A) | 69. (D) | 94. (D) |
| 20. (D) | 45. (A) | 70. (B) | 95. (B) |
| 21. (B) | 46. (C) | 71. (A) | 96. (C) |
| 22. (A) | 47. (D) | 72. (B) | 97. (A) |
| 23. (D) | 48. (B) | 73. (D) | 98. (B) |
| 24. (C) | 49. (D) | 74. (B) | 99. (A) |
| 25. (A) | 50. (B) | 75. (D) | 100. (D) |

76. (C) Replace 'since' by 'for'. 'For' comes for a indefinite period of time, e.g., 'twenty years'.
77. (A) Sentence starting with 'scarcely' takes an inversion form. Put 'had' before 'my father'.
- 86 (C) In a comparison, we take comparative degree of adjective.
87. (D) No Improvement
90. (D) The correct spelling of 'Conductive' is 'Conducive'.
91. (D) The correct spelling of 'Incomprehensible' is 'Incomprehensible'.