

KD
Campus
KD Campus Pvt. Ltd

2007, OUTRAM LINES, 1ST FLOOR, NEAR GTB NAGAR METRO STATION, GATE NO. - 2, DELHI-110009

Answer-key & Solution

SSCJE (Civil)
MOCK -(83)
Date 28.01.2017

1. A	26. D	51. D	76. C	101. D	126. C	151. A	176. A
2. D	27. A	52. B	77. C	102. B	127. B	152. C	177. C
3. A	28. B	53. C	78. C	103. B	128. D	153. C	178. B
4. A	29. C	54. D	79. C	104. A	129. C	154. A	179. C
5. A	30. D	55. C	80. C	105. D	130. C	155. D	180. D
6. C	31. B	56. C	81. B	106. B	131. A	156. D	181. C
7. B	32. C	57. A	82. C	107. A	132. B	157. B	182. C
8. B	33. D	58. A	83. B	108. B	133. D	158. C	183. A
9. B	34. C	59. C	84. B	109. B	134. A	159. D	184. B
10. C	35. B	60. C	85. A	110. B	135. B	160. C	185. A
11. A	36. B	61. A	86. C	111. B	136. D	161. C	186. A
12. A	37. C	62. C	87. A	112. D	137. D	162. A	187. D
13. A	38. D	63. B	88. D	113. C	138. C	163. A	188. B
14. A	39. D	64. A	89. D	114. B	139. C	164. C	189. D
15. C	40. A	65. D	90. B	115. D	140. B	165. B	190. C
16. C	41. C	66. D	91. B	116. D	141. A	166. A	191. D
17. B	42. C	67. D	92. A	117. B	142. D	167. A	192. A
18. C	43. C	68. C	93. C	118. C	143. C	168. C	193. B
19. A	44. C	69. D	94. B	119. D	144. B	169. A	194. B
20. B	45. B	70. C	95. B	120. D	145. A	170. A	195. A
21. B	46. A	71. C	96. D	121. A	146. C	171. D	196. C
22. B	47. B	72. C	97. B	122. B	147. D	172. A	197. C
23. C	48. C	73. D	98. C	123. B	148. C	173. B	198. A
24. B	49. B	74. B	99. B	124. B	149. A	174. B	199. D
25. C	50. D	75. D	100. D	125. D	150. B	175. A	200. C

Correction Mock Test 82-
101. (C)

Note : *If your opinion differ regarding any answer, please message the mock test and Question number to 9560620353*

Note : *If you face any problem regarding result or marks scored, please contact : 9313111777*

SOLUTION SSC JE (Civil) MOCK TEST no. 83

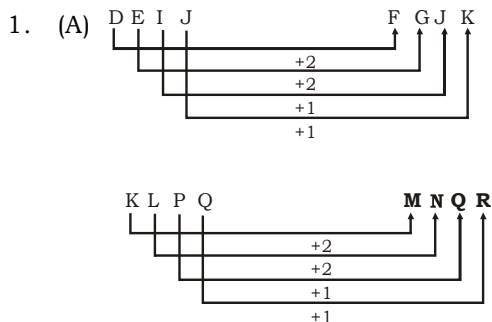

2. (D) $5 : 35 :: 7 : 77$
 $\times 7$ (next prime no. to 5) $\times 11$ (next prime no. to 7)

3. (A) Tadpole is transformed into **frog** and caterpillar is transformed into butterfly.
 4. (A) Elated is the opposite of despondent and enlightened is the opposite of **Ignorant**.

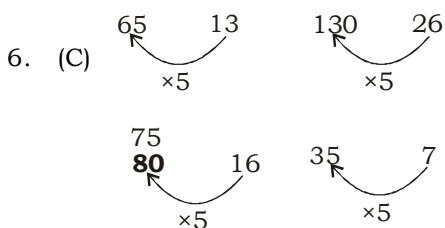
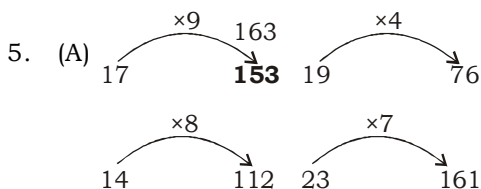

7. (B) All except river contain stagnant water.
 8. (B) Except hamlet, rest are put on head.

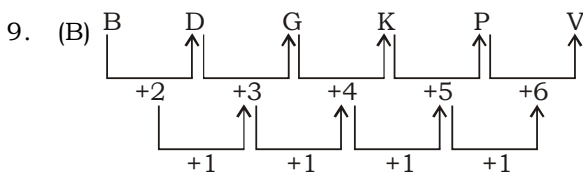

10. (C) $1 \rightarrow 3 \rightarrow 5 \rightarrow 2 \rightarrow 4$
 11. (A) $c c \underline{b} a / c c a b / c c b a / c c a \underline{b} / c c \underline{b} a$

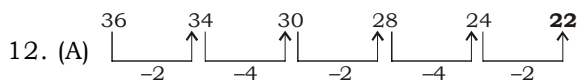

13. (A)

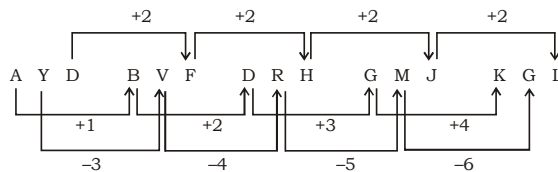

14. (A)

B	A	L	L	O	O	N
05	04	15	15	18	18	17
L	A	G	O	O	N	
15	04	10	18	18	17	

15. (C) Suresh is the father of that Boy.
 16. (C) RATION
 17. (B) $(6 \times 8) + (7 \times 9) = 48 + 63 = 111$
 $(5 \times 6) + (9 \times 7) = 30 + 63 = 93$
 $(6 \times 6) + (8 \times 7) = 36 + 56 = 92$

18. (C) $24 \times 6 = 144 \Rightarrow \frac{144}{2} = 72$

$152 \times 2 = 304 \Rightarrow \frac{304}{2} = 152$

$9 \times 18 = 162 \Rightarrow \frac{162}{2} = 81$

$\therefore ? = 9$

19. (A) Initial Position

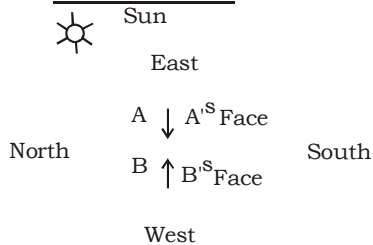

Current Position

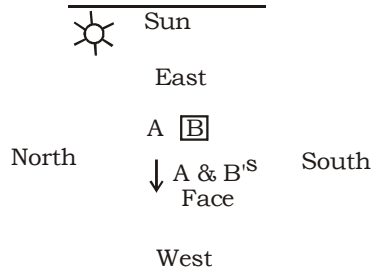

So, it is clear that both A & B are now facing towards west.

20. (B) After interchanging the signs, we have
 $40 \div 8 \times 7$
 $= 5 \times 7 = 35$

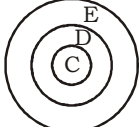
21. (B)  1 ✓
2 ×
3 ✓
4 ×

Only (I) and (III) follows

22. (B) There are 8 corners. So, required number of cubes will always be 8.
26. (D) Look for opposites in this series of figures. The first and second segments are opposites of each other. The same is true for the third and fourth segments.
27. (A) Jalka means happy; mofti means birthday; hoze means party; mento means good; and gunn means the suffix ness. We know the answer must include the suffix ness. The only choice that uses that suffix is choice (A).
28. (B) The students union formation shall be a step towards giving to students the basic education in the field of politics. However, it shall create the same political atmosphere in the campus. Thus, both the arguments hold strong.
29. (C) The correct order is :
 Seed Plant Tree Flowers Fruit
 2 5 1 3 4
30. (D) Gold and Zinc are different from each other but both are metal.
31. (B) Trunk, Fruit and leaf are the parts of the tree.
32. (C) $15 = 3 \times 5$
 $35 = 5 \times 7$
 $99 = 9 \times 11$
 $77 = 7 \times 11$

Except (C), others are product of consecutive prime numbers. 9 is not a prime number.

33. (D)
- | | No. of const. (A) | No. of Vowels (B) | A ² | B ³ |
|------|-------------------|-------------------|----------------|----------------|
| ROAD | 2 | 2 | 4 | 8 |
| SHIP | 3 | 1 | 9 | 1 |
| ARE | 1 | 2 | 1 | 8 |
| DEAR | 2 | 2 | 4 | 64 |

The word 'DEAR' is different from others, as DEAR = 464 ≠ 84.

34. (C) Let there be $(x + 1)$ members. Then,

Father's share = $\frac{1}{4}$, share of each other

member = $\frac{3}{4x}$

$$\therefore 3\left(\frac{3}{4x}\right) = \frac{1}{4} \Leftrightarrow 4x = 36 \Leftrightarrow x = 9.$$

Hence, total number of family members = 10

35. (B) A and B are children of D. From (1), C is the brother B and son of F. Since, the sex of D and E are not known. Hence (1) is not sufficient to answer the question. From (2), F is the mother of B. Hence, F is also the mother of A. Hence D is the father of A. Thus, (2) is sufficient to answer the question.
36. (B) As the numbers 2, 3, 4 and 5 are adjacent to 6. Hence the number on the face opposite to 6 is 1.

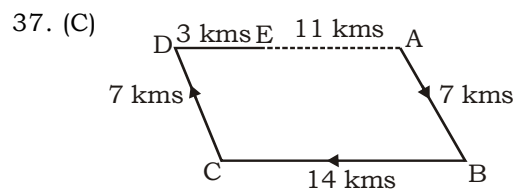

\therefore Required distance (AE) = $(14 - 3) = 11$ kms

38. (D)

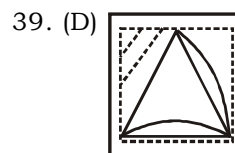

40. (A) In each row, the central part of the first figure rotates either 90° CW or 90° ACW to form the central part of the second figure and the central part of the first figure rotates through 180° to form the central part of the third figure. Also, in each row, there are 3 types of side elements i.e., rectangles, circles and triangles.

42. (C) $8 \times 0.5 + 2 = 6$

$$6 \times 1 + 3 = 9$$

$$9 \times 2 + 4 = 22$$

$$22 \times 4 + 5 = \mathbf{93}$$

$$93 \times 8 + 6 = 750$$

43. (C) The figure may be labelled as shown.

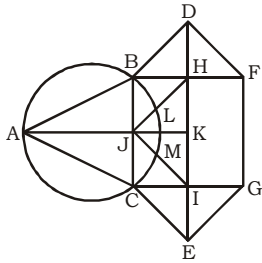

Simplest triangles are ABJ, ACJ, BDH, DHF, CIE and GIE i.e. 6 in number.

Triangles composed of two components each are ABC, BDF, CEG, BHJ, JHK, JKI and CJI i.e. 7 in number.

There is only one triangle JHI which is composed of four components.

Thus, there are $6 + 7 + 1 = 14$ triangles in the given figure.

44. (C) We can't find 2 E's in the word 'HERBIVOROUS'.

45. (B)

46. (A) $(5 \times 4) - (6 \times 3) = 2 \Rightarrow 2^3 = 8$
 $(3 \times 6) - (5 \times 3) = 3 \Rightarrow 3^3 = 27$

47. (B)

48. (C) FIRE = 2 const. & 2 vowel = $(2)^3$ & $(2)^2 \Rightarrow 84$
 RAINBOW = 4 const. & 3 vowel = $(4)^3$ & $(3)^2$
 $\Rightarrow 649$

49. (B) $8 \times 1 + 5 = 13$
 $13 \times 2 + 4 = 30$
 $30 \times 3 + 3 = 93$
 $93 \times 4 + 2 = 374$
 $374 \times 5 + 1 = \mathbf{1871}$

50. (D) J A Y S U R Y A
 17 26 2 8 6 9 2 26 = 96
 $\Rightarrow 96 \times 8(\text{no. of letters}) = 768$
 L A R A
 15 26 9 26 = 76 $\Rightarrow 76 \times 4(\text{no. of letters})$
 $= 304$
 T E N D U L K A R
 7 22 13 23 6 15 16 26 9 = 137
 $\Rightarrow 137 \times 9(\text{no. of letters}) = \mathbf{1233}$

51. (D) The Dholavira is the largest Indus Valley Site in independent India. It is located on Khadir Beyt, an island in the Great Rann of Kutch in Gujarat. It has been excavated by R S Bisht team of ASI. It had three citadels. Each of these three citadels of Dholavira was improved than Harappa and

Mohen-jo-Daro and had an inner closure as well.

52. (B) Dadabhai Naoroji is known as mentor of both Gopal Krishna Gokhale and Mahatma Gandhi. His magnum opus "Poverty and Unbritish Rule in India" propounded the "drain theory" He was the first Indian to become a member of the House of Commons on the Liberal Party ticket. He became the president of INC thrice, in 1886, 1893 and 1906.

53. (C) India's first touch-and-feel garden for visually impaired has been inaugurated by the Kerala Assembly Speaker P Sreerama Krishnan on the Calicut University campus in Thenjipalam, Kerala. The garden with nearly 6 dozen aromatic plants will provide the visually impaired a unique opportunity of learning. They can study the plants not only by touching, feeling, smelling and tasting them, but also through audio inputs to get complete information about them.

54. (D) The World Elephant Day is observed every year on August 12th to create awareness of the urgent plight of African and Asian elephants, and to share knowledge and positive solutions for the better care and management of captive and wild elephants.

55. (C) The chemical formula for Nitrolim talc is $[\text{Mg}_2 (\text{Si}_2\text{O}_7)_2 \cdot \text{Mg}(\text{OH})_2]$

57. (A) BCD is a binary coded notation in which each of the decimal digits is expressed as a 8-bit binary numeral. For example in binary coded decimal notation 12 is 0001 0010 as opposite to 1100 in pure binary.

59. (C) India's first repository on tigers will be set up by the Wildlife Institute of India (WII) under its new Tiger Cell at Dehradun, Uttarakhand. The cell will have a database of tigers from over 50 reserves around the country along with their DNA and stripes samples to keep a track on their numbers. If a tiger skin is recovered, the tiger cell will help in locating the area from where it came from. The purpose of the repository is to aid conservation efforts by keeping an update on tiger numbers as well as tracking poaching incidents throughout the country. The tiger cell will be funded by the National Tiger Conservation Authority (NTCA), which is a statutory body under the Ministry of Environment. It will also give clearance to development projects in areas with tiger population.

61. (A) The book "What Lies Between Us" has been authored by Nayomi Munaweera. It is a novel that sets out to explain one such crime and the possible causes behind it. It is the confession of a woman, driven by the demons of her past to commit a single and possibly unforgivable crime.
63. (B) Calcium Carbide when reacts with Nitrogen at high temperature, gives Nitrolim. It is a mixture of calcium cyanamide and carbon.
- $$\text{CaC}_2 + \text{N}_2 \xrightarrow{1100^\circ\text{C}} \text{CaCN}_2 + \text{C}$$
64. (A) The unicorn is the most common motif on Indus seals and appears to represent a mythical animal that Greek and Roman sources trace back to the Indian subcontinent.
65. (D) Rourkela steel plant is the first Integrated Steel plant in the public sector in India. It was setup with German collaboration.
67. (D) Chambal river is an example of superimposed drainage. A superimposed river does not adjust with the structure of its place of origin. First of all the river valley is built on upper part and then the river develops and expands such structure in the lower part.
68. (C) The National Highways Authority of India (NHAI) has recently signed Memorandum of Understanding (MOU) with IIT-Kharagpur for research project to develop technology to construct long lasting maintenance free highways in India. IIT-Kharagpur will develop 'Paneled Cement Concrete Pavements' for highways. The duration of the research project is 3 years.
70. (C) White cement does not contain iron, hence it is white (as iron reacts with H_2O of atmosphere and forms FeS , which is black in colour).
71. (C) Agriculture continues to play the primary role in the country's development and is still the mainstay to our large growing population for its sustained food security.
72. (C) Madhya Pradesh is the only Diamond producing state and is leading producer of copper concentrate, pyrophyllite and diaspore. State hosts country's 68% diaspore, 41% molybdenum ore, 46% pyrophyllite, 32% diamond, 29% copper ore, 17% rock phosphate, 16% each of manganese ore and fireclay and 11% ochre resources.
76. (C) The first National Conference of Investigating Agencies was held from August 12th to 13th, 2016 at Vigyan Bhawan in New Delhi. The two-day conference was inaugurated by the Union Home Minister Rajnath Singh. The conference was attended by more than 100 delegates from States/UTs/Central Police Organisations.
77. (C) Viratnagar, capital of Matsya Mahajanpada was located near present Jaipur. It was used as a hiding place by Pandavas during 13th year of their exile.
78. (C) The Maharashtra government has recently launched India's first comprehensive 'Crime Criminal Tracking Network System' (CCTNS) through 42 cyber labs in Mumbai on August 15th, 2016. Under the CCTNS, all police stations in the state will be linked with one another for sharing information about crimes in their respective jurisdictions and pave the way for a digital police force in Maharashtra.
79. (C) Both the statements are correct in this question. The total land boundary of India is about 15,200 km and the total length of the coast line of the mainland including Andaman and Nicobar and Lakshadweep is 7,516.6 km. This implies that land border of India is approximately twice of the coastline of the country.
80. (C) A.R. Rahman, is the Oscar-winning music maestro, has been honoured by the New York-based Tamil Sangam with its Tamil Ratna Award. Rahman was bestowed with the award after his concert at the United Nations General Assembly (UNGA) to honour M.S. Subbulakshmi's birth centenary. The concert was sponsored by the India's UN Mission and Sankara Nethralaya, a Chennai-based charity organization.
81. (B) The Railway bridge being constructed over the Chenab River in Jammu & Kashmir is planned to have a height of 359 meters from river bed level which, as per available information, is the highest railway bridge in the world. The railway bridge over river Chenab is a part of Udhampur-Srinagar-Baramulla new line project which, on completion, is expected to connect Anantnag, Pulwama, Sopian, Badgam, Srinagar and Baramulla districts of Jammu & Kashmir State to the Railway network.
83. (B) R.K. Shanmukham Chetty was the first Finance Minister of independent India. He presented the first budget of independent India on November 26th, 1947.

84. (B) CDBT Chairperson is responsible for transfers and postings of officers in the cadre of Chief Commissioner of Income-tax and Commissioner of Income-tax.
85. (A) The act 1892 can be said to be a First step towards the beginning of the parliamentary system in India, where the members are authorized to ask questions. Indian Councils act 1892 can also be said to introduce the principle of representation.
86. (C) Gypsum ($\text{CaSO}_4 \cdot 2\text{H}_2\text{O}$), about 2 - 5% is added to retard the setting action of cement.
89. (D) Raja Ram Mohan Roy has come to be called the 'Maker of Modern India'. He was the main force behind introduction of the western education and English language in India. He advocated the study of English, Science, Western Medicine and Technology. He spent his money on a college to promote these studies. He was the founder of the Brahma Samaj and a great leader of social reform. It was as a result of his persistent campaign that the custom of Sati was declared illegal in Bengal in 1829 A.D. by Lord William Bentick. He was the chief advocate of the modern process of education and the scientific learning.
97. (B) The book "A Book of Light: When a Loved One Has a Different Mind" has been authored by Jerry Pinto. The book is a collection of stories from people who recount their experiences of living with loved ones with a mental illness. In a society where the subject is rarely discussed openly, even among family, the book reminds us that we need many more such personal accounts.
98. (C) Polysiloxane are usually used for hair setting in beauty parlours. These Silicon based compounds have an affinity for the hair and form a film at hairs surface.

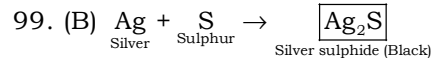

- 104.(A) Magnetic quadrantal bearing of a line
 $\text{QB} = \text{S}46^\circ 30'\text{W}$
 $\text{WBC} = 180^\circ + \text{QB}$
 $= 180^\circ + 46^\circ 30'$
 $= 226^\circ 30'$
 magnetic declination = $2^\circ 30'\text{E}$
 then true whole circle bearing = $\text{WBC} + 2^\circ 30'$
 $= 226^\circ 30' + 2^\circ 30'$
 $= 229^\circ$

115.(B) $L_2 = L_1 \left(\frac{d_2}{d_1} \right)^5 = 1000 \left(\frac{40}{20} \right)^5$
 $= 1000 \times (2)^5 = 1000 \times 32 = 33000\text{m.}$

118.(C) $Q = a \times v$

$$v = \frac{Q}{a} = \frac{30}{12} = 2.5\text{m / sec.}$$

$$E = h + \frac{v^2}{2g}$$

$$= 2 + \frac{(2.5)^2}{2 \times 10} = \frac{40 + 6.25}{20} = 2.31$$

161.(C) $\gamma_t = \frac{G \cdot \gamma_w \cdot (1 + w)}{(1 + e)}$

$$\gamma_t = \frac{G \cdot \gamma_w \cdot (1 + w)}{(1 + e)}$$

$$(1 + e) = 1.56$$

$$e = 0.56$$

$$w = \frac{S \cdot e}{G}$$

$$S = \frac{w \cdot G}{e} = \frac{0.20 \times 2.6}{0.56}$$

$$= 0.9285 = 92.85\% \approx 92\%$$