



# KD Campus Pvt. Ltd

2007, OUTRAM LINES, 1ST FLOOR, OPPOSITE MUKHERJEE NAGAR POLICE STATION, DELHI-110009

## Answer-key & Solution

SSC JE (Electrical)  
MOCK -(92)  
Date:- 8.4.2017

1. C	26. A	51. A	76. B	101. B	126. A	151. B	176. A
2. B	27. A	52. C	77. B	102. A	127. D	152. C	177. A
3. c	28. C	53. D	78. B	103. A	128. D	153. C	178. A
4. C	29. B	54. B	79. C	104. D	129. B	154. A	179. B
5. C	30. D	55. C	80. C	105. D	130. A	155. C	180. B
6. C	31. C	56. A	81. D	106. D	131. D	156. B	181. B
7. A	32. D	57. C	82. A	107. A	132. A	157. A	182. C
8. D	33. B	58. A	83. B	108. B	133. D	158. C	183. C
9. C	34. A	59. C	84. A	109. B	134. D	159. C	184. A
10. D	35. C	60. A	85. D	110. B	135. C	160. C	185. A
11. D	36. D	61. B	86. C	111. B	136. A	161. B	186. C
12. D	37. d	62. D	87. B	112. B	137. D	162. C	187. B
13. C	38. B	63. B	88. B	113. D	138. D	163. C	188. B
14. A	39. D	64. B	89. B	114. B	139. C	164. C	189. D
15. D	40. B	65. B	90. C	115. B	140. D	165. B	190. A
16. B	41. B	66. A	91. B	116. B	141. B	166. C	191. D
17. C	42. B	67. B	92. B	117. A	142. D	167. D	192. D
18. B	43. D	68. B	93. A	118. C	143. A	168. C	193. B
19. C	44. B	69. B	94. A	119. B	144. C	169. B	194. C
20. C	45. D	70. D	95. D	120. D	145. A	170. B	195. C
21. c	46. C	71. A	96. A	121. A	146. D	171. A	196. C
22. D	47. A	72. A	97. C	122. B	147. C	172. B	197. A
23. A	48. A	73. B	98. A	123. C	148. D	173. A	198. C
24. D	49. B	74. B	99. A	124. C	149. D	174. D	199. C
25. B	50. D	75. D	100. A	125. B	150. D	175. B	200. A

### Correction Mock Test 91 (131. D)

**Note :** If your opinion differ regarding any answer, please message the mock test and Question number to 9560620353

**Note :** If you face any problem regarding result or marks scored, please contact : 9313111777

**SOLUTION SSC JE (Electrical) MOCK TEST no. 92**

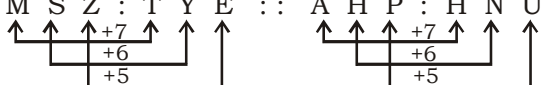
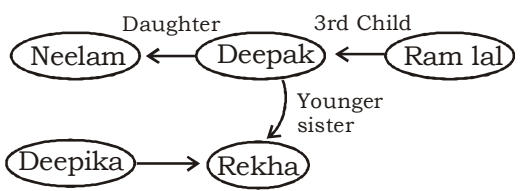
1. (C)  $M S Z : T Y E :: A H P : H N U$   

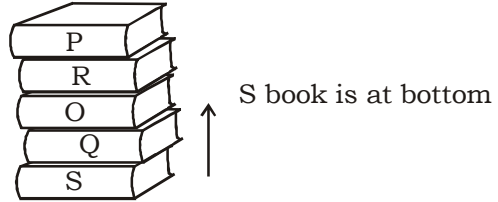
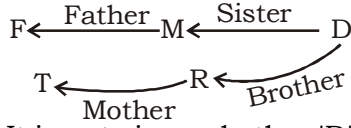
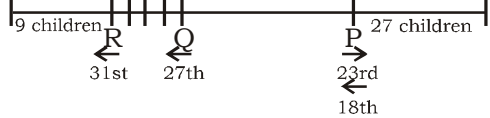
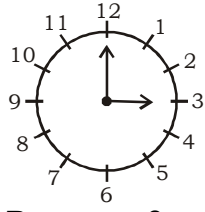
2. (B) Here,  $13 \times 14 = 182$   
 Similarly,  $18 \times 19 = 342$   
 Hence, the question mark should be replaced by 18.
3. (C) £ is the currency of England. Currency of China has sign ¥.
4. (C) COME : 36 :: SUN : 54  
 $3+15+13+5 = 36$      $19+21+14 = 54$
5. (C) Blue whale is the biggest animal in sea. In the same way Elephant is the biggest animal on land.
6. (C) Life and Death are opposite. In the same way Hope and Despair are opposite to each other
7. (A) Unemployment brings poverty. In the same way Malnutrition brings Anaemia.
8. (D) (A)  $(11)^2 + (11 - 2) = 130$   
 (B)  $(18)^2 + (18 - 2) = 340$   
 (C)  $(15)^2 + (15 - 2) = 238$   
 (D)  $(17)^2 + (17 - 2) = 304$
9. (C)  $KP \quad HS \quad QJ \quad IR$   
 $11+16=27 \quad 8+19=27 \quad 17+10=27 \quad 9+19=27$   
 ↓  
 Except 'C' Ist letter is after the IInd letter in Alphabet series.
10. (D) All are primary colours except Black.  
 11. (D) All are related to time except Again.  
 12. (D)  
 13. (C)  $7 \xrightarrow{\times 3+6} 27 \xrightarrow{\times 2-6} 48 \xrightarrow{\times 3+6} 150 \xrightarrow{\times 2-6} 294 \xrightarrow{\times 3+6} 888$
14. (A)  $52 \xrightarrow{7^2+3} 124 \xrightarrow{11^2+3} 172 \xrightarrow{13^2+3} 292 \xrightarrow{19^2+3} 364$
15. (D)  $B \ C \ E \ G \ K \ M \ Q$   
 $2 \ 3 \ 5 \ 7 \ 11 \ 13 \ 17$
16. (B)  $324 \xrightarrow{+111} 435 \xrightarrow{+111} 546 \xrightarrow{+111} 657 \xrightarrow{+111} 768$   
 D G K    M P T    V Y C    E H L    N Q U
17. (C)  $4 \ 7 \ 11 \ 13 \ 16 \ 20 \ 22 \ 25 \ 3 \ 5 \ 8 \ 12 \ 14 \ 17 \ 21$   
 $+3 \ +4 \ +2 \ +3 \ +4 \ +2 \ +3 \ +4 \ +2 \ +3 \ +4 \ +2 \ +3 \ +4$
18. (B)  $2 \xrightarrow{\times 2.5} 5 \xrightarrow{+3} 8 \xrightarrow{\times 2.5} 20 \xrightarrow{+3} 24 \xrightarrow{\times 2.5} 60 \xrightarrow{+3} 65 \xrightarrow{\times 2.5} 162.5$
19. (C) a **b** d / b c a / **c** d b / d a **c** / a **b** d / b c a
20. (C) 
21. (C) 95 D 19 R 11 S 28 A 17

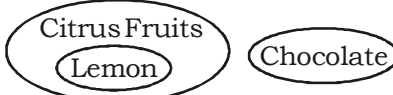
- $\div \quad \times \quad - \quad +$   
 $5 \times 11 - 28 + 17$   
 $= 55 - 11 = 44$
22. (D) One complete circle =  $360^\circ$   
 $n \times 24^\circ = 360^\circ$   
 $n = \frac{360}{24} = 15$   
 One side = 18 m  
 Then total Distance =  $18 \times 15 = 270$  m
23. (A) 
24. (D)   
 It is not given whether 'D' is a male or a female, So Data is inadequate
25. (B)   
 Now, the total number of children between P and R  
 $31 - 18 = 13$
26. (A) Here,  
 1st January 2003 : Wednesday  
 31st December 2003 : Wednesday  
 1st January 2004 : Thursday  
 31st December 2004 : Friday  
 [Note that if a non-leap year starts with the day x then the last day of the year will be x. Whereas if a leap year starts with the day x then the last day of the year will be (x+1).]
27. (A)   
 Between 3 and 4 minute hand  $24^\circ$   
 behind mean  $\Rightarrow \frac{24}{6} = 4$  min gap.  
 $(15-4) = 11$  min  
 $11 \times \frac{12}{11} = 12$  min.    So, 12 min, past 3

28. (C) 

29. (B) 

18	121	13
27	212	21
21	60	17

 $(I - III)^3 - 4 = II$   
 $(18 - 13)^3 - 4 = 121$   
 $(27 - 21)^3 - 4 = 212$   
 $(21 - 17)^3 - 4 = 60$

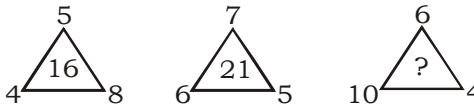
30. (D) 

$$\frac{5 \times 4 \times 8}{10} = 16 \quad \frac{6 \times 7 \times 5}{10} = 21 \quad \frac{6 \times 10 \times 4}{10} = 24$$

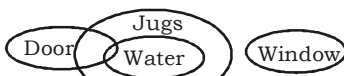
31. (C) 

x    ✓    x    ✓  
I    II    III    IV

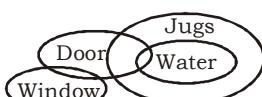

x    ✓    x    ✓  
I    II    III    IV

Only II and IV follow.

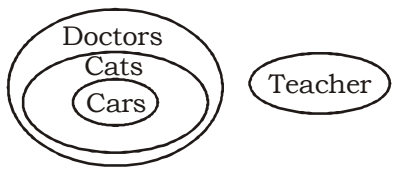
32. (D) 

x    ✓    ✓    x  
I    II    III    IV

33. (B) A Z AB Y ABC X ABCD W ABCDE V  
ABCDEF  
One alphabet is increasing.

34. (A) A8B6#7HU%3\$FV R21@41WE9©L5  
← 15th from right  
→ 7th to the right

$$15 - 7 = 8$$

i.e. 8th from the right

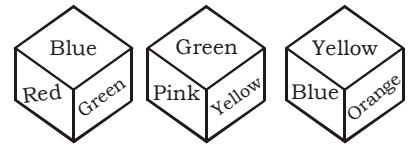
35. (C) 

Blue, Red, Green, **Pink**, Yellow, Orange

x    x    x    x    x

36. (D) Hand Shaking Rule

$$= \frac{\text{Men} \times \text{Contribution} \times (\text{Men} - 1)}{2}$$

$$= \frac{16 \times 1 \times (16 - 1)}{2} = 120$$

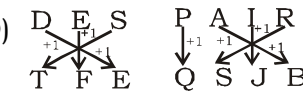
37. (D) 

Similarly,

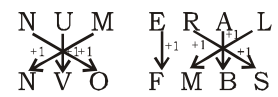

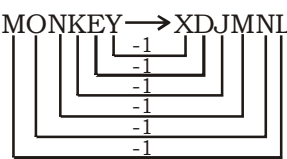
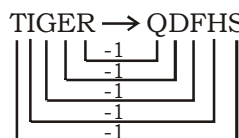
38. (B) MONKEY → XDJMNL  
  
 TIGER → QDFHS  

39. (D) (i) lee ra de → what was it  
 (ii) mo nil → you go  
 (iii) nil pom ra → you like it  
 (iv) tok lee to → she was sick  
 what you like → nil pom de  
 ir → ra was → lee what → de

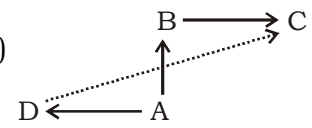
40. (B) 

Village C is in North-East of Village D.

41. (B) CRITICAL word can not make from PHARMACEUTICAL.

42. (B)  
 Money → Plot → Planning → Building → Rent  
 4            1            2            5            3

43. (D)                    44. (B)                    45. (D)  
 46. (C)                    47. (A)                    48. (A)  
 49. (B)                    50. (D)

103. (A)  
**Short Method**  
 Circuit look like a balance bridge  
 $C_1 C_4 = C_2 C_3$   
 $C^2 = C^2$   
 Hence equivalent capacitance  
 $= \frac{C.C}{C+C} + \frac{C.C}{C+C} \Rightarrow C = 10\mu f$

112. (B) Equivalent resistance  
 $= \left( \left[ \left[ (10+10) \parallel 20 \right] + 6 \right] \parallel 16 \right) + 2 = 10 \text{ ohm}$   
 Reading of ammeter =  $\frac{100V}{10\Omega} = 10 \text{ Amp.}$

113. (D) Connects a battery of V Volt between P

and Q point and marked the current.

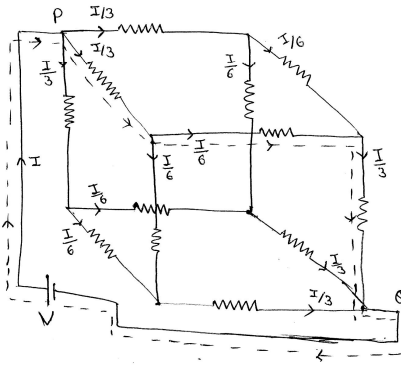

$$\frac{I}{3}R + \frac{I}{6}R + \frac{I}{3}R = V$$

$$\frac{5IR}{6} = V \Rightarrow \frac{5R}{6} = \frac{V}{I}$$

$$R_{eq} = \frac{5}{6}R \Omega$$

116. (B) Do the source conversion from current source to voltage source and apply KVL,  $3 - 3I - 3I = 0$

$$I = \frac{3}{2}A$$

$V_{oc}$  = Voltage across 3 ohm resistance

$$3 \times \frac{3}{2} = \frac{9}{2} \text{ Volt}$$

Equivalent thenin resistance

$$R_{eq} = (1+2) || 3 = \frac{3}{2} \Omega$$

$$V_{oc} = \frac{9}{2}V, R_{eq} = \frac{3}{2} \Omega$$

118. (C)

$$R_{eq} = \left( \left[ \left( (40+20+20) || 80 \right) + 20+20 \right] || 80 \right) + 10+10$$

$$R_{eq} = 60 \Omega$$

126. (A)  $E_a = V - I_a R_a$   
 $E_a = 200 = 220 - I_a \times 0.5$   
 $I_a = 40A$

136. (A)

$$\eta = \frac{\text{output}}{\text{output} + \text{loss}}$$

$$= \frac{4 \times 1}{4 \times 1 + 0.2 + 0.2} \times 100 = 90.9\%$$

170. (B) In case of FB photo diode it is insensitive to incident light and behave as a normal diode so diode current remains same irrespective of intensity of incident light.

193. (B)  $H = \frac{\text{Stored kinetic energy}}{\text{Machine rating}}$

$$= \frac{400 \times 10^6}{50 \times 10^6} = 8 \text{ MJ/MVA } 199.$$