



# KD Campus Pvt. Ltd

2007, OUTRAM LINES, 1ST FLOOR, OPPOSITE MUKHERJEE NAGAR POLICE STATION, DELHI-110009

## Answer-key & Solution

SSC JE (Electrical)  
MOCK -(106)  
Date:- 15.7.2017

1. A	26. A	51. C	76. C	101. A	126. A	151. B	176. B
2. D	27. B	52. C	77. C	102. D	127. D	152. A	177. A
3. C	28. B	53. A	78. B	103. A	128. A	153. C	178. B
4. C	29. B	54. B	79. A	104. B	129. C	154. A	179. C
5. C	30. B	55. D	80. A	105. A	130. D	155. A	180. A
6. B	31. A	56. C	81. B	106. A	131. B	156. C	181. D
7. D	32. C	57. D	82. C	107. B	132. B	157. D	182. D
8. D	33. D	58. D	83. C	108. A	133. B	158. C	183. B
9. C	34. D	59. C	84. C	109. D	134. B	159. C	184. C
10. D	35. A	60. B	85. C	110. D	135. B	160. A	185. A
11. C	36. B	61. C	86. C	111. A	136. A	161. D	186. C
12. A	37. A	62. B	87. A	112. C	137. D	162. D	187. A
13. C	38. D	63. A	88. C	113. D	138. C	163. A	188. C
14. D	39. B	64. D	89. D	114. D	139. A	164. B	189. D
15. D	40. D	65. A	90. A	115. A	140. C	165. C	190. B
16. D	41. C	66. A	91. B	116. D	141. B	166. B	191. B
17. D	42. D	67. C	92. B	117. C	142. D	167. C	192. C
18. B	43. C	68. C	93. D	118. D	143. D	168. C	193. A
19. C	44. C	69. D	94. A	119. B	144. A	169. D	194. C
20. B	45. C	70. A	95. A	120. B	145. C	170. C	195. C
21. C	46. C	71. C	96. C	121. C	146. D	171. D	196. C
22. C	47. B	72. A	97. B	122. C	147. A	172. A	197. A
23. D	48. C	73. C	98. C	123. B	148. A	173. C	198. B
24. C	49. B	74. C	99. B	124. C	149. A	174. D	199. A
25. C	50. C	75. C	100. B	125. C	150. A	175. B	200. C

**Note :** If your opinion differ regarding any answer, please message the mock test and Question number to 9560620353

**Note :** If you face any problem regarding result or marks scored, please contact : 9313111777

**SOLUTION SSC JE (Electrical) MOCK TEST no. 106**

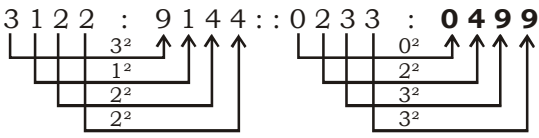
1. (A) On the television a programme is telecast. In the same way on the radio a programme is broadcast.
2. (D) Antonyms of Day is Night, So antonyms of Dusk will be dawn.
3. (C) Mouth is related to articulation. In the same way music is related to tune.
4. (C) If Gravity is related to pull. In the same way Magnetism is related to Attraction.
5. (C)  $8^3 = 512 \rightarrow$  Reverse of 512 is 215  
 $6^3 = 216 \rightarrow$  Reverse of 216 is 612
6. (B)  $6 \times 3 + 2 = 20, 5 \times 3 + 2 = 17$
7. (D)  $3\ 1\ 2\ 2\ : 9\ 1\ 4\ 4\ :: 0\ 2\ 3\ 3\ : 0\ 4\ 9\ 9$   

8. (D)  $115^2 = 13225, 165^2 = 27225$
9. (C) Steering wheel, engine and tyre are the parts of a car.
10. (D) Except Vishakhapatnam, all are the capitals of states.
11. (C) (A)  $\begin{matrix} +1 \\ \downarrow \\ U & R & T \\ \uparrow +2 \\ \hline \end{matrix}$  (B)  $\begin{matrix} +1 \\ \downarrow \\ G & D & F \\ \uparrow +2 \\ \hline \end{matrix}$   
 (C)  $\begin{matrix} +2 \\ \downarrow \\ P & L & N \\ \uparrow +2 \\ \hline \end{matrix}$  (D)  $\begin{matrix} +1 \\ \downarrow \\ N & K & M \\ \uparrow +2 \\ \hline \end{matrix}$
12. (A) (A)  $\begin{matrix} \uparrow +1 & \uparrow +1 \\ J & K & L \\ \hline \end{matrix}$  (B)  $\begin{matrix} \uparrow +1 & \uparrow +2 \\ F & G & I \\ \hline \end{matrix}$   
 (C)  $\begin{matrix} \uparrow +1 & \uparrow +2 \\ M & N & P \\ \hline \end{matrix}$  (D)  $\begin{matrix} \uparrow +1 & \uparrow +2 \\ T & U & W \\ \hline \end{matrix}$
13. (C) Guitar, Violin & Veena are stringed instruments but flute is a wind instrument.
14. (D)  $6\ 13\ 18\ 25\ 30\ 37\ 40 \rightarrow 42$   
 $\begin{matrix} \uparrow +7 & \uparrow +5 & \uparrow +7 & \uparrow +5 & \uparrow +7 & \uparrow +5 \\ \hline \end{matrix}$
15. (D) Desk, Chair and Bench are open furniture. Cupboard is a closed furniture.
16. (D) Golf, Cricket and Hockey are outdoor games. Carrom is an Indoor game.
17. (D) Rest are odd numbers.
18. (B)  $2, 3, 10, 15, 26, 35, 50, 63$   
 $\begin{matrix} \downarrow & \downarrow & \downarrow & \downarrow & \downarrow & \downarrow & \downarrow & \downarrow \\ 1^2+1 & 2^2-1 & 3^2+1 & 4^2-1 & 5^2+1 & 6^2-1 & 7^2+1 & 8^2-1 \end{matrix}$
19. (C)  $8 \times 8 \times 88 = 5632$   
 $7 \times 7 \times 77 = 3773$   
 $9 \times 6 \times 58 = 3132$

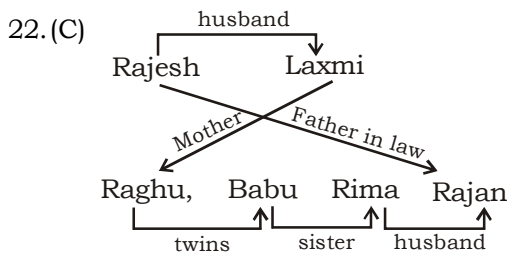
20. (B)  $\frac{28}{7} + 4 = 8, \frac{35}{5} + 3 = 10, \frac{32}{8} + 5 = 9$
21. (C)  $7 + 8 - 9 = 6, 1 + 19 - 10 = 10,$   
 $14 + 10 - 16 = 8$

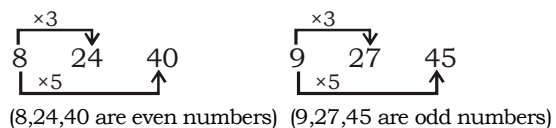
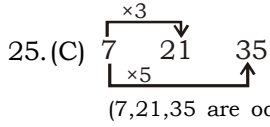

23. (D)  $K > B$  and  $Y > B > J$ . It means J is on bottom.
24. (C) Dog is called as Elephant.



26. (A)  $16 + 4 \div 2 \times 3 = 22 = 16 + 2 \times 3 = 16 + 6 = 22$
27. (B) After replacing the \* sign we have  
 $(49 \div 7 \times 3 - 5 + 8 = 24)$   
 $7 \times 3 - 5 + 8 = 24$   
 $21 + 8 - 5 = 24$   
 $29 - 5 = 24$   
 $24 = 24$

28. (B) VIEW

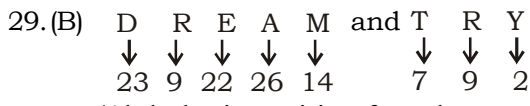

(Alphabetic position from last to first)  
 Similarly,  
 S K Y  
 $\downarrow \downarrow \downarrow$   
 8 16 2

30. (B) Set of three letters are horizontally reversed.

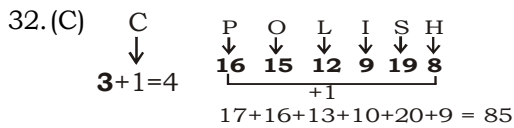
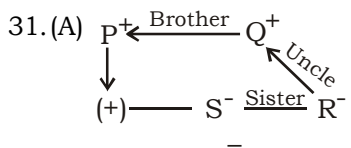

P O I N T E R  
↓ ↓ ↓ ↓ ↓ ↓ ↓  
**16 15 9 14 20 5 18**  
+1

$$17+16+10+15+21+6 + 19 = \mathbf{104}$$

33. (D)

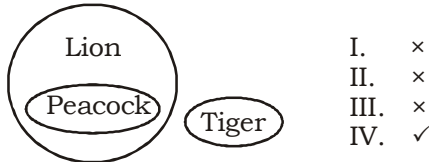

34. (D) Both the conclusions do not have relation with the statement.

35. (A)

36. (B)

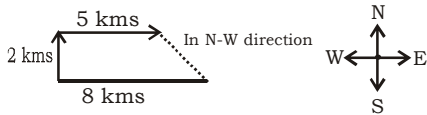

38. (D) A is 9th from left and B is 5th from right position. After interchanging their positions, position of A will be 18th from the left

It means there are 8 people sitting between them

Now position of B from Right =  $(5 + 8) + 1 = 14$

39. (B) Next bus is at 10:30 in the morning which means previous bus was at 10:00 in the morning. An enquiry was given 10 minutes after bus had left. It means an enquiry staff has given the information at 10:10 in the morning.

40. (D) Number of students who play cricket  
=  $25 + 16 = 41$

43. (C)

P	Q	R	S
June	July	August	September
30	31	31	30

48. (C) Series of continuous prime numbers  
2, 3, **5**, 7, 11, **13**, **17**, 19, **23**

49. (B) **A** EIOU **E** IOUA **I** OUA E **O** UA E I **U** AEIO

50. (C)

51. (C) Market failure is an economic term that encompasses a situation wherein any given market, the quantity of a product demanded by consumers does not equate to the quantity supplied by suppliers. This is a direct result of a lack of certain economically ideal factors, which presents equilibrium. Market failure has negative effects on the economy because an optimal allocation of resources is not attained.

52. (C) C. Raja Gopalachari is also referred as 'Rajaji'. He was elected as a president of the Tamil Nadu congress Committee. The Vedaranyam March or Vedaranyam

Satyagraha was organised to protest the salt tax imposed by the British Raj in India. The march took place in 1930 and was second of its kind of Dandi March organised by Gandhiji both in the framework of Civil Disobedience Movement. The Vedaranyam March was led by a group of 100 volunteers from the Indian National Congress (INC) under the leadership of Rajaji. It began at Trichinopoly (now Tiruchirappalli) and ended in Vedaranyam, a small coastal town in Tanjore District. The marchers broke the salt law. The campaign ended on 28th April 1930.

53. (A) Edicts of Ashoka are a collection of 33 inscriptions on the pillars of Ashoka. These edicts describes Ashoka's view about dhamma. In these inscriptions Ashoka refers himself as 'Beloved of the Gods' (Devnampriya priyadarshi). Ardhamagadhi is an archaic form of Magadhi language of ancient India following the decline of Pali and Sanskrit. In his edicts he laid emphasis on equality or universal brotherhood in Prakrit language ardhmagadhi.

56. (C) The 'Principle of Maximum Social Advantage' was introduced by British economist Hugh Dalton. 'Public Finance' is concerned with income and expenditure of public authorities and with the adjustment of one with the other.

58. (D) Every state has a legislative Assembly. Certain states have an Upper House also known as State Legislative Council. There is a governor for each state who is appointed by the President. Governor is the head of the state and the executive power of the state is vested in him. The council of Minister with the Chief Minister as its head advises the Governor in the discharge of the executive functions. The council of Minister of a state is collectively responsible to the legislative Assembly of the state

59. (C) The Labrador Current is a cold current in North Atlantic Ocean which flows from the Arctic Ocean south along the coast of Labrador and passes around New Foundland along the east coast of Nova Scotia. It is the continuation of west Greenland current and the Baffin Island current. At the Grand Banks in south east of New foundland it meets the

- warm Gulfstream. The combination of these two currents produces heavy fogs and creates richest fishing grounds in the world. Labrador current produces cooling effect on Canadian Atlantic provinces and USA upper North East coast.
60. (B) Fixed investment is the investment in fixed capital, physical assets like machinery, land, buildings installations, vehicles or technology.
61. (C) Kaal Baishakhi is also known as Nor'wester. It causes dramatic appearance in the afternoon or evening of pre-monsoon months over Bengal, Bihar, Assam and adjoining areas. It is a subject of universal interest for a number of reasons. It not only gives relief after mid-day heat but pours well on its crops. It's nature is unique and the causes are really interesting. Kaal Baishakhi is a localised thunderstorm associated with violent thunderstorms and torrential rainfall in India. Basically in Bengal, it is known as Kaal Baisakhi' or calamity of the month of Baisakh (April 15-May15). In some parts of India it helps in ripening of mangoes and hence it is also known as mango shower.
62. (B) The special economic zone (SEZ) policy in India first came into inception on April 1, 2000. Its main objective was to enhance foreign investment and provide an internationally competitive and hassle free environment for exports. Its Idea was to promote exports from the country and realising the need that level playing field must be made available to the domestic enterprises and manufactures to be competitive globally.
63. (A) An economy in which no activity is conducted with outside economies is called a closed economy. In a closed economy no imports are brought in and no exports are sent out and it prohibits any other country from participating in their stock market
64. (D) The factory was first set up in India to produce Ammonium Sulphate (1951), Urea (1959), Ammonium Nitrate-Sulphate commonly known as Double Salt (1959) and was the first fertilizer factory to have its own captive power plant (1951) and to introduce planning, research and development facilities in 1951. Raw materials used were Gypsum. Coal and Naptha.
65. (A) Bats use ultrasonic sound for navigation. Their ability to catch flying insects while flying full speed in pitch darkness is astounding. Their sophisticated echolocation permits them to distinguish between a moth and a falling leaf.
66. (A) Persistence of vision is the theory where an afterimage is thought to persist for approximately one-sixteenth of a second on the retina and believed to be the explanation for motion perception. In a moving camera, each picture leads into the next one, so they blur together to make a single movie image. This is known as persistence of vision.
67. (C) The fuse wire works on the principle of Joules law of heating. The main objective of using fuse wire in electric circuit is to provide protection against short circuit or overloading of current. When large current passes in the circuits, the fuse wire burns and breaks the circuit. So, material used in fuse wire should have high resistance and low melting point. Due to high resistance wire heats up quickly, when huge current flows. The temperature around fuse wire rapidly rises, it reaches to the melting point of the material it burns and protects the circuit. Material used as fuse wire is an alloy of tin and lead.
69. (D) In 1951, Edward Teller invented Hydrogen Bomb. It is a weapon that uses a mixture of fission and fusion to produce a massive explosion.
74. (C) Hydrolysis is degradation of chemical bond by the addition of water. When a carbohydrate is broken into its component sugar molecules by hydrolysis like sucrose broken down into glucose and fructose, this is termed as saccharification.
75. (C) Refrigeration is a process of moving heat from one location to another. The heat transport is driven by mechanical work, magnetism, electricity, laser etc. Its applications are-household refrigerators, industrial freezers, cryogenics and air conditioning. Refrigeration slows bacterial action to a crawl so that it takes food much longer to spoil.

78. (B) Chloromycetin is used in the treatment of infections caused by bacteria. It works by killing bacteria or preventing their growth.
- 83 (C) Alfalfa is a common flowering perennial plant that originated in Asia. It is a nutrient rich food, high in chlorophyll, vitamins and micronutrients. Eating alfalfa or alfalfa sprouts offers the advantage of more protein than in most plants. It is rich in vitamins A, B1, B6, C, E and K as well as in Calcium, Potassium, Iron and Zinc.
88. (C) The first Factory Act was passed in 1881 in the tenure of Lord Rippon to prohibit child labour.
- Lord Rippon (1880-1884)-
- (i) He repealed the Vernacular Press Act in 1882.
  - (ii) Age for entry in civil services was again raised to 21 years.
  - (iii) He passed Local Self Government Act in 1882.
  - (iv) He introduced Ilbert Bill in 1883. He was also known as Father of Local Self Government in India.
89. (D) Ramanuja (1060-1118) - The earliest exponent of the Bhakti Movement was Ramanuja. He established Vaishnavism on a sound foundation. He founded visistadvaita Siddhanta or qualified monism and according to him, the way to salvation lies through karma, Gyan and Bhakti. He wrote Sribasya and Gita Bhasya.
91. (B) Kathakalli, Kuchipudi and Bharatnatyam are classical dances and Bhangra is a folk dance of Punjab region.
- ⇒ Bharatnatyam is the oldest classical dance forms in India. Mainly practiced in the present day region of Tamil Nadu.
  - ⇒ Kathakalli is practiced in Kerala.
  - ⇒ Kuchipudi in the state of Andhra Pradesh
97. (B) The DOT (Department of Telecom) has formed a panel to examine economic impact of implementation of net-neutrality principle on the sector, to charge extra for voice call services like Skype and Viber. Net neutrality principle says that access to Internet or any Internet based service should be without any barrier or discrimination. A six member committee is formed under A.K Bhargava to examine pursuit of net neutrality from public policy

- objective, its advantages and limitations.
98. (C) The New Development Bank (NDB) formerly referred to as BRICS Development Bank. The bank is set up to foster greater financial and development cooperation among the fine emerging markets. On May 11, 2015 K. V Kamath was appointed as President of the Bank. He has served as the chairman of Infosys Limited, the second largest Indian IT service company and as the Non-Executive Chairman of ICICI Bank
99. (B) During 11th five year plan, a new state plan scheme of Additional Central Assistance (ACA) for agriculture and allied sectors, namely RKVY (Rashtriya Krishi Vikas Yojana) was launched during 2007-2008.
104. (D) Here multiplier factor is 4.  
So, Actual power = m.f. × meter reading  
 $= 2 \times 200 = 8000W$
106. (A)  $24 - 8(I_B + I_C) - 5 - 0.230 I_E = 0$   
 $24 - 8 I_E - 5 - 0.23 I_E = 0$   
 $19 - 8.23 I_E = 0$   
 $I_E = 2.308 \text{ mA}$   
 $V_{CE} = V_{BE} + V_{CB}$   
 $5 = 0.7 + I_B R$   
 $5 = 0.7 + \frac{I_E}{(\beta + 1)} R$   
 $R = \frac{4.3}{2.308} \times 46 \times 10^3$   
 $R = 85.64K\Omega$
113. (D)  $4 = 124 \left( \frac{50k}{50k+X} \right)$   
 $\Rightarrow X = 15 \text{ k}\Omega = 1.5 \text{ M}\Omega$
116. (D) let at time t, magnetic energy reaches to  $\frac{1}{4}$  of its maximum.

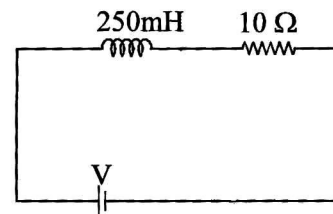

Energy  $E = \frac{1}{2} Li^2$   
 $e \propto i^2$

i.e. current that time should be  $\frac{\text{max}}{2}$



$$\frac{1}{2} = e^{-tR/L}$$

$$\ln \frac{1}{2} = \frac{tR}{L}$$

$$\frac{rR}{L} = \ln 2$$

$$t = \frac{L}{R} \ln 2$$

$$= \frac{250 \times 10^{-3}}{10} \ln 2 = \frac{1}{40} \log_e 2$$

120. (B) Frequency of magnetic field energy is twice of supply frequency.

$$\therefore \frac{T}{2} = 2 \times [10\text{m}]$$

$$\Rightarrow T = 40 \times 10^{-3}$$

$$f = 25 \text{ Hz}$$

122. (C)  $E_b = \frac{NP\phi Z}{60A}$

$$E_b \propto K \phi N$$

$$E_b = V_t - I_a(R_a + R_{se})$$

$$= 400 - 20(0.08 + 0.06)$$

$$E_{b1} = 397.2 \text{ V}$$

$$E_{b2} = 400 - 50(0.14)$$

$$= 400 - 7 = 393 \text{ V}$$

$$\frac{E_{b1}}{E_{b2}} = \frac{\phi_1 N_1}{\phi_2 N_2}$$

$$\frac{397.2}{393} = \frac{\phi_1 \times 1100}{(1.3)\phi_1 \times N_2}$$

$$N_2 = 837.2$$

171. (D)  $a_{\text{auto}} = \frac{210}{140} = 1.5$

$$\frac{I_1}{I_2} = \frac{1}{a_{\text{auto}}}$$

$$\Rightarrow I_2 = a_{\text{auto}} \times I_1 = 1.5 \times 60 = 90 \text{ A}$$

At point A,

$$I_1 + I_C = 90$$

$$I_C = 90 - I_1$$

$$= 90 - 60 = 30 \text{ A}$$

174. (D) The voltage across the capacitor is give as

$$V_C(t) = V \left( 1 - e^{-\frac{t}{RC}} \right)$$

$$\frac{d}{dt} V_C(t) = V \left( \frac{1}{RC} e^{-\frac{t}{RC}} \right)$$

$$\frac{d}{dt} V_C(t)_{\text{at } t=0} = \frac{V}{RC} e^0 = \frac{V}{RC}$$

177. (A)  $i = \frac{2}{T} \cdot t$

$$\text{and } V_L = L \cdot \frac{di}{dt}$$

$$= L \cdot \frac{d}{dt} \left( \frac{2}{T} \cdot t \right)$$

$$= \frac{2L}{T} = \text{constant}$$

180. (A)  $I_m \rightarrow \text{Same}$

$\therefore$  For HWR Current

$$I_{\text{rms}} = \frac{I_m}{2}$$

$$I_m = 2 I_{\text{rms}}$$

$$= 2 \times 50 = 100 \text{ A}$$

For FWR

$$I_{\text{rms}} = \frac{I_m}{\sqrt{2}}$$

$$= \frac{100}{\sqrt{2}} = 70.71 \text{ A}$$

188. (C) By using potentiometer

$$V_{\text{actual}} = I \times R$$

$$\Rightarrow 1.2 = I \times R \quad \dots(1)$$

$$V_m = I(R || 60K)$$

$$\Rightarrow 0.9 = I \times \frac{R \times 60K}{60K + R} \quad \dots(2)$$

From equation (1)  $\div$  (2)

$$\frac{1.2}{0.9} = \frac{IR \times (60K + R)}{IR \times 60K}$$

$$\Rightarrow R = 20 \text{ k}\Omega$$

191. (B) For DOL starting,

$$T_{st_2} \propto \left( \frac{V}{\sqrt{3}} \right)^2$$

$$\frac{T_{st_1}}{T_{st_2}} = 3$$

$$\Rightarrow T_{st_2} = \frac{T_{st_1}}{3}$$

192. (C) Resistance temperature coefficient of copper at 20°C is 0.00393/°C

193. (A) 1hp = 765 watt  
watt-seconds

$$= 765 \times 2 \times 5 \times 3600$$

$$= 2.6856 \times 10^7$$

194. (C) When a multiplier is added to an existing voltmeter for extending its range its electromagnetic damping decreases.

195. (C)

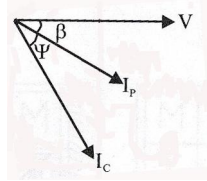

$$P = V \cos \beta \cdot I_c \cos \psi$$

$$P = V I_c \cos \beta \cos \psi$$

$$P \propto \cos \beta \cos \psi$$

196. (C) In indicating instruments the springs are mainly used to control the pointer movement.

197. (A) For sinusoidal voltage PMMC reads zero.

198. (B) To maximize the driving torque in an induction type instrument, flux produced by shunt coil and series coil should be in quadrature with each other.

199. (A) To minimize the errors due to lead and contact resistance, low resistances used in electrical measurement work are provided with guard rings.

200. (C) Dielectric stress =  $\frac{1}{\text{diameter}}$

$$\frac{\text{maximum Dielectric stress}}{\text{minimum dielectric stress}} = \frac{D}{d}$$